

Keysight 81150A and 81160A Pulse Function Arbitrary Noise Generators

Data Sheet
Version 1.3





Introduction

High precision pulse generators enhanced with versatile signal generation, modulation and distortion capabilities for:

- Accurate signals to test your device and not your signal source
- Versatile waveform and noise generation to be ready for today's and tomorrow's stress test challenges
- Optional pattern generator to test in addition to analog, digital and mixed signal devices
- Integrated into one instrument to minimize cabling, space and test time

The 81150A Pulse Function Arbitrary Noise Generator at a Glance

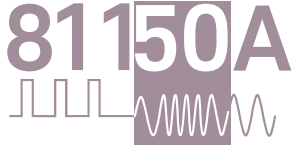

- 1 μ Hz – 120 MHz pulse generation with variable rise/fall time
- 1 μ Hz – 240 MHz sine waveform output
- 14-bit, 2 GSa/s arbitrary waveforms
- 512 k samples deep arbitrary waveform memory per channel
- Pulse, sine, square, ramp, noise and arbitrary waveforms
- Noise, with selectable crest factor, and signal repetition time of 26 days
- FM, AM, PM, PWM, FSK modulation capabilities
- 1- or 2- channel, coupled and uncoupled
- Differential outputs
- Two selectable output amplifiers:
 - High bandwidth amplifier
 - Amplitude: 50 mV_{pp} to 5 V_{pp}; 50 Ω into 50 Ω
100 mV_{pp} to 10 V_{pp}; 50 Ω into open
 - Voltage window: \pm 5 V; 50 Ω into 50 Ω
 \pm 10 V; 50 Ω into open
 \pm 9 V; 5 Ω into 50 Ω
 - High voltage amplifier
 - Amplitude: 100 mV_{pp} to 10 V_{pp}; 50 Ω into 50 Ω ,
200 mV_{pp} to 20 V_{pp}; 5 Ω into 50 Ω , or 50 Ω into open
 - Voltage window: \pm 10 V; 50 Ω into 50 Ω
 \pm 20 V; 5 Ω into 50 Ω or 50 Ω into open
- Glitch-free change of timing parameters (delay, frequency, transition time, width, duty cycle)
- Programming language compatible with Keysight 81101A, 81104A, 81105A, 81110A, 81130A and 81160A
- ISO 17025 and Z540.3 calibration
- LXI class C (rev. 1.1) compliant
- Optional pattern generator:
 - Ideal and arbitrary bit shaped pattern up to 120 Mbit/s
 - Two, three or four level signals
 - PRBS up to 231
 - 16 Mbit pattern memory
 - Pass through pattern for combined and physical and protocol test up to 10 Mbit/s

The 81160A Pulse Function Arbitrary Noise Generator at a Glance

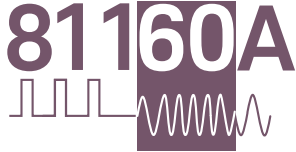

- 1 μ Hz – 330 MHz pulse generation with variable rise/fall time
- 1 μ Hz – 500 MHz sine waveform output
- 14-bit, 2.5 GSa/s arbitrary waveforms
- Up to 256k samples deep arbitrary waveform memory per channel
- Pulse, sine, square, ramp, noise and arbitrary waveforms
- Noise, with selectable crest factor, and signal repetition time of 20 days
- FM, AM, PM, PWM, FSK modulation capabilities or 2 channel, coupled and uncoupled
- Differential outputs

- Amplitude:
 - 50 Ω into 50 Ω 50 mV_{PP} to 5 V_{PP}
 - 50 Ω into open 100 mV_{PP} to 10 V_{PP}

- Voltage window:
 - 50 Ω into 50 Ω \pm 5 V
 - 50 Ω into open \pm 10 V

- Glitch-free change of timing parameters (delay, frequency, transition time, width, duty cycle)
- Programming language compatible with Keysight 81101A, 81104A, 81105A, 81110A, 81130A and 81150A
- ISO 17025 and Z540.3 calibration
- LXI class C (rev 1.1) compliant
- Optional pattern generator:
 - Ideal and arbitrary bit shaped pattern up to 330 Mbit/s (Option 330) or 660 Mbit/s (Option 660)
 - Two, three or four level signals
 - PRBS up to 231
 - 4 Mbit pattern memory for the 1-channel instrument and 2 Mbit per channel for the 2-channel instrument
 - Pass through pattern for combined and physical and protocol test up to 10 Mbit/s

81150A

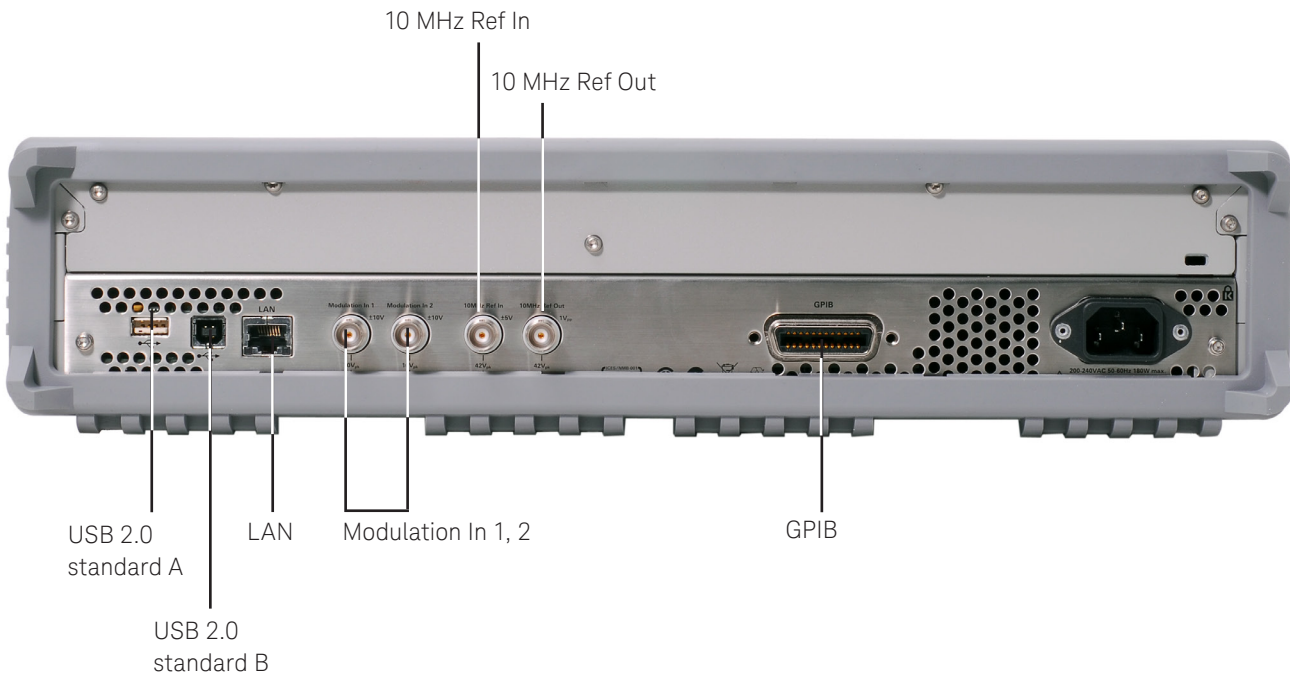
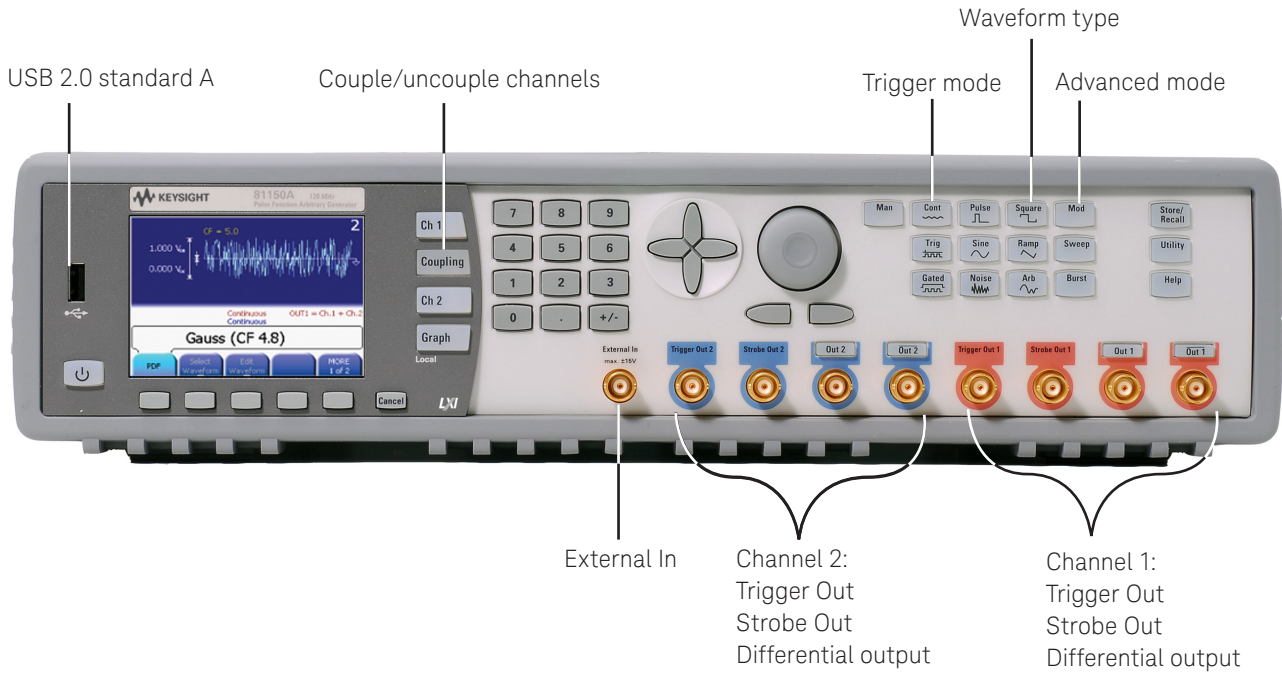
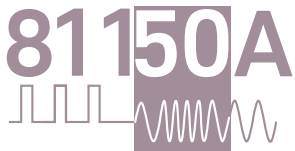

81160A

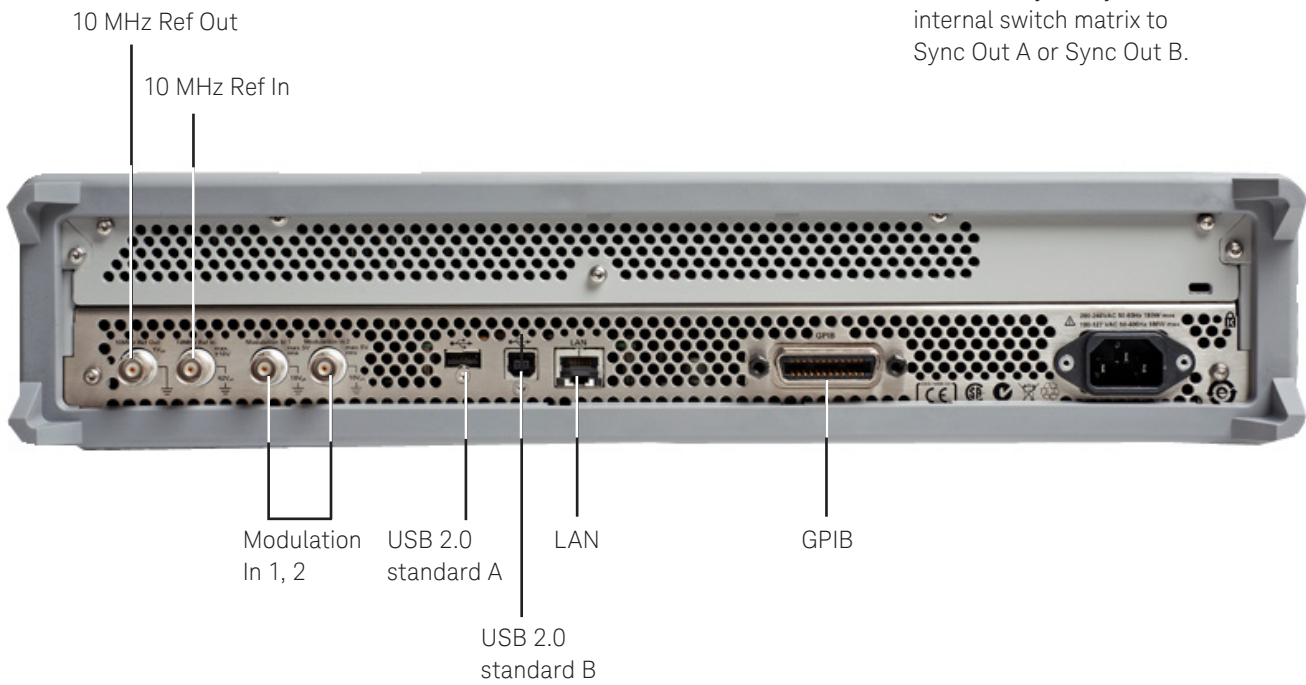
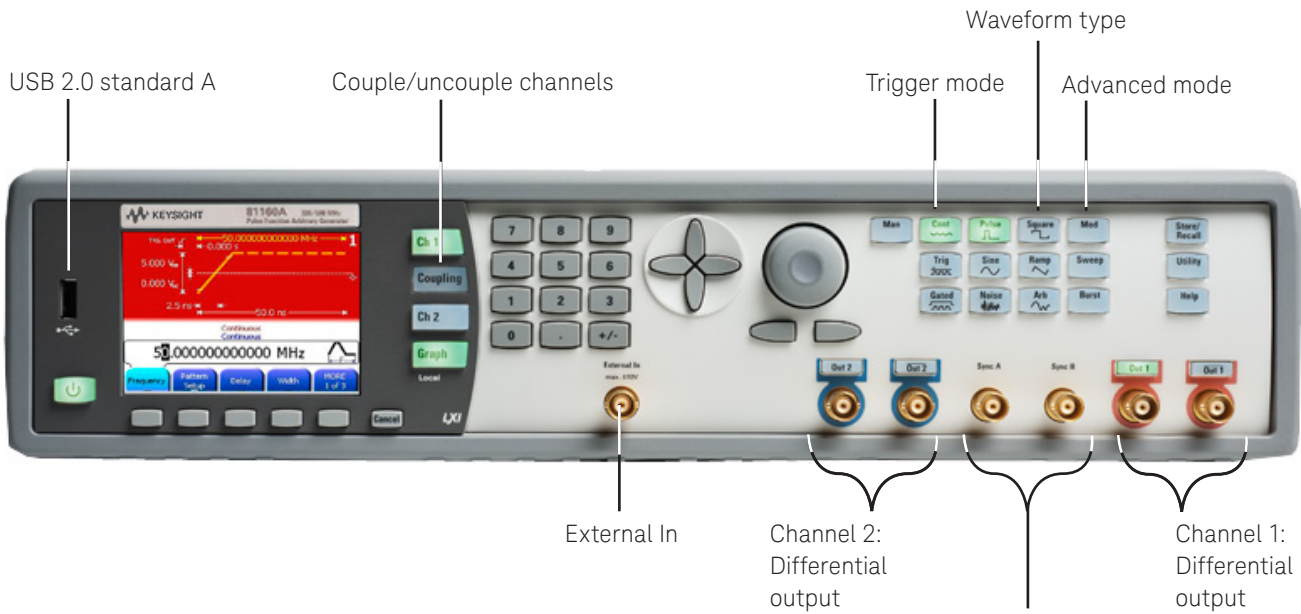

Sync out A and B:
 The logical trigger signal 1 or logical trigger signal 2 or logical strobe signal 1 or logical strobe signal 2 can be routed by a fully flexible internal switch matrix to Sync Out A or Sync Out B.

Today's Challenges Require a New Generation of Test Instruments

You are under pressure to get products to market faster and faster, with shrinking design schedules and increasing quality goals. The pressure is never ending. Because differentiation means survival in the marketplace, you often have to test unique functionality. Being confident in your results takes highly adaptable and efficient testing.

Such challenges require a new generation of test instruments, which are:

- Accurate, to test your device and not your source
- Versatile, to be ready for today's and tomorrow's test challenges
- Plug and play solutions, with minimal cabling, low space overhead and have many functions built-in

Whichever way you look at it, this starts with accurate, versatile and uncompromising signal sources.

Keysight's offering

Just test – with the signal you need.
Quad versatility – optimum signal fidelity

The Keysight Technologies, Inc. 81150A and 81160A Pulse Function Arbitrary Noise Generators set the standard for the next generation of lab: for fast, accurate insight into your design or device under test. Both of them offer:

- Pulse generators with precise signals for performance verification and characterization function arbitrary generator
 - For versatile signal generation to optimize testing
 - For modulation to shape the signal the DUT needs
- A noise generator to distort signals to build up worst case scenarios
- An optional pattern generator to test in addition to analog, digital and mixed signal devices with ideal and real-world conditions

The Keysight 81150A and the new Keysight 81160A Pulse Function Arbitrary Noise Generators are indispensable contributors to accelerate ideal and real-world testing.

Pulse generator

Pattern generator



Function arbitrary generator

Noise generator

Pulse Generator – Test Your Device and Not Your Source

Superior precision pulses with unbeatable timing stability guarantee reproducible tests. The signal quality and trigger functionality provide everything you need for trigger or system clock applications.

You can change the timing parameters (delay, frequency, transition time, width, duty cycle) without dropouts or glitches. This patented, industry-leading feature means continuous operation without having to reboot or reset your device under test, for example when you are characterizing a device by sweeping the clock frequency. Apart from full control of the timing parameters, you can also adjust levels and edges as needed.

Channel 1 pulse setup

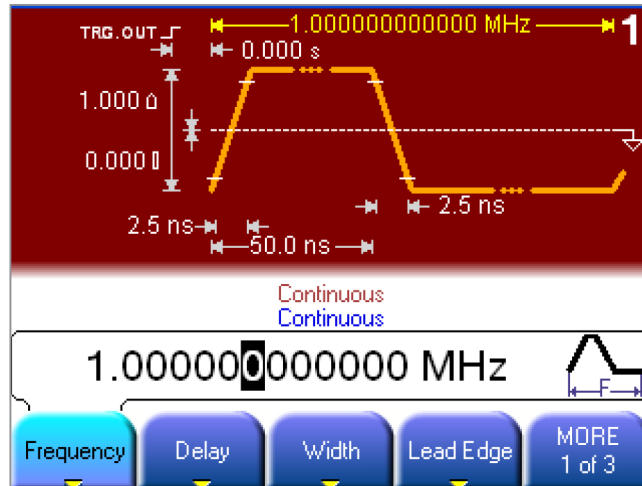

Set up complex measurements

Both, the Keysight 81150A and the Keysight 81160A Pulse Function Arbitrary Noise Generator, are available in a 1- or 2-channel version. On the two-channel version, the channels can be uncoupled, to work independently, or coupled, for example, with a defined delay between them.

Each channel provides Trigger Out, Strobe Out and differential outputs: the basis for many complex test setups.

Measurement using strobe and trigger

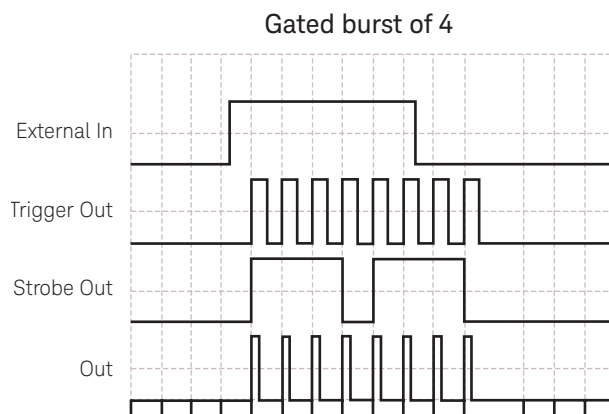

Function Arbitrary Generator

Stress Your Device to its Limit

If you need further signal conditioning, the Keysight 81150A and the Keysight 81160A Pulse Function Arbitrary Noise Generators provide versatile waveforms and modulation capabilities to adapt your signal to your device's requirements. AM, FM, FSK, PM and PWM are available at modulation frequencies up to 10 MHz and to 50 MHz.

The Keysight 81150A and the Keysight 81160A Pulse Function Arbitrary Noise Generators can use internal or external modulation sources. Internal modulation can be generated from the 2nd channel or the internal modulation source of the modulated channel.

Amplitude modulation

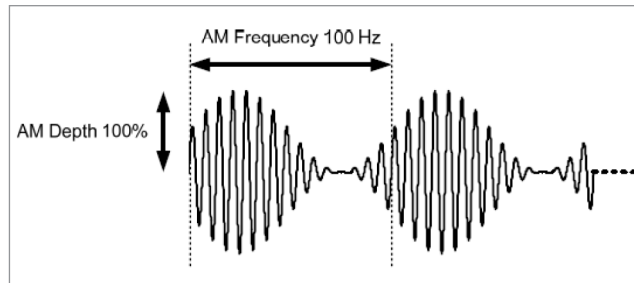

Frequency shift keying modulation

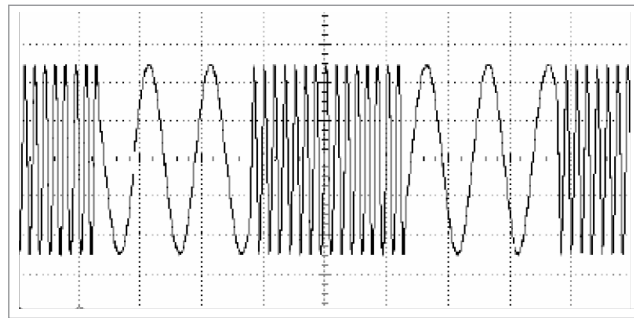

Pulse width modulation

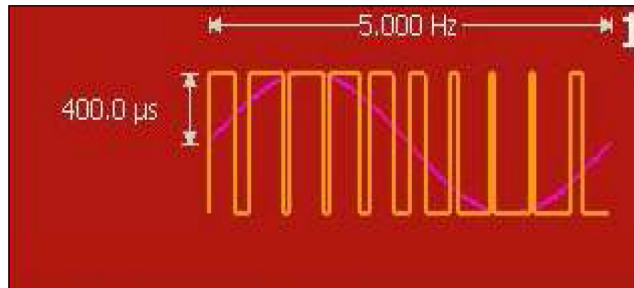

Frequency sweep

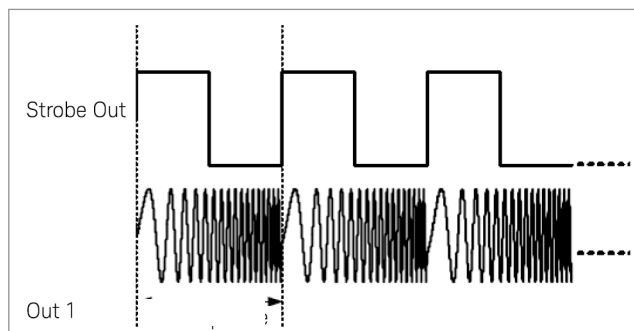

Setting up a measurement using trigger, strobe, modulation and carrier

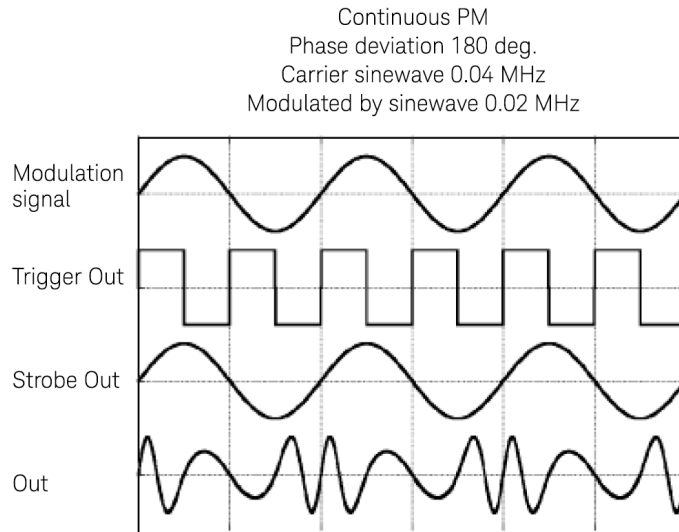

Noise generator – repeatable and stochastic noise

Jitter and noise cause misalignment of edges and levels, resulting in data errors. Noise is by its nature unpredictable because it can have many different causes, from signal interference caused by sudden voltage changes, to distortions introduced during transmission.

It is important to be able to simulate noise-based malfunctions, for example, to identify the additive noise produced by receiving systems—it is cheaper to lower the noise figure than to increase the transmitter power! The Keysight 81150A and the Keysight 81160A Pulse Function Arbitrary Noise Generators let you control the quality of the noise, to test different cases, and according to various specifications.

White Gaussian noise is a good approximation to many real-world situations, and creates mathematically traceable models, with statistical independent values. The Keysight 81150A and the Keysight 81160A Pulse Function Arbitrary Noise Generators provide deterministic white Gaussian noise, with a signal repetition of 20 days or 26 days respectively. You can decide on any arbitrary distribution, and trigger the noise to start when you need it.

Gaussian curve and distribution

Gaussian distribution

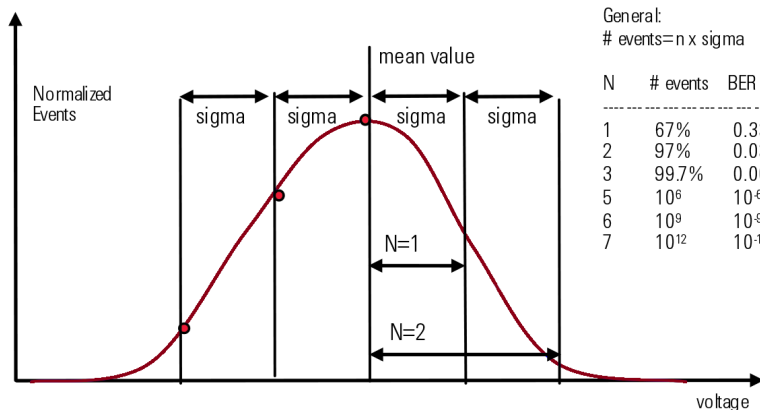

Voltage level crest factor

You can also select the crest factor out of 4 values – an indicator of signal quality – using V_P/V_{RMS} or V_{PP}/V_{RMS} scales, depending on the standard to which you are testing.

The 81150A and the 81160A use the definition: crest factor = V_P/V_{RMS}

Voltage level crest factor

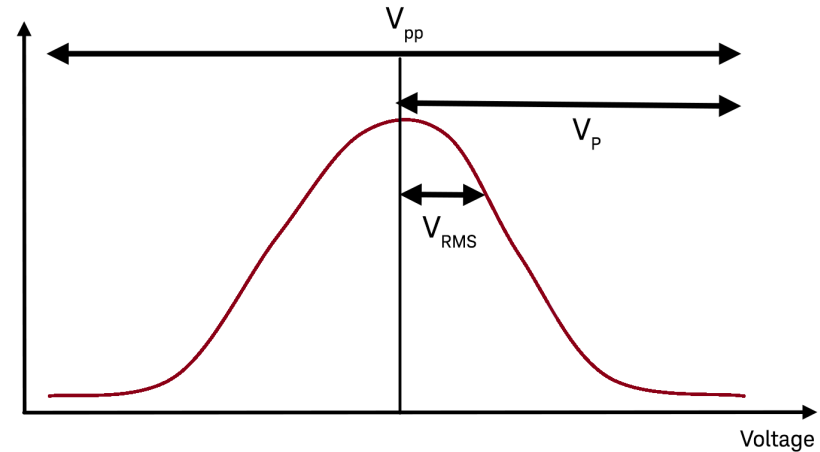

The result is noise that combines two extremes:

- Random and repeatable noise, for stress tests on one side
- While still being sufficiently random

Pattern Generator – Test in Addition to Analog, Digital and Mixed Signal Devices

Engineers working with serial buses or designers of analog, digital and mixed signal devices require stressing their design with pattern. The optional Keysight 81150A and 81160A arbitrary bit shaped pattern generator allows sending ideal and real-world pattern. The Keysight 81150A with arbitrary bit shaped pattern (Option PAT) allows emulating overshoot, asymmetric delay and duty cycle distortion up to 120 Mbit/s, the Keysight 81160A up to 330 Mbit/s (Option 330) or even up to 660 Mbit/s (Option 660). Patterns can be easily set up and distorted at your fingertips.

Stress your device to its limits – define your own bit shape

Emulate effects like...

- Capacitive load of the channel
- Asymmetric delay
- Crossing point deviations
- Duty cycle distortions
- Arbitrary transition times
- Level noise
- Delays from/to electrical idle

...By defining the transitions so that the previous bit influences the current bit

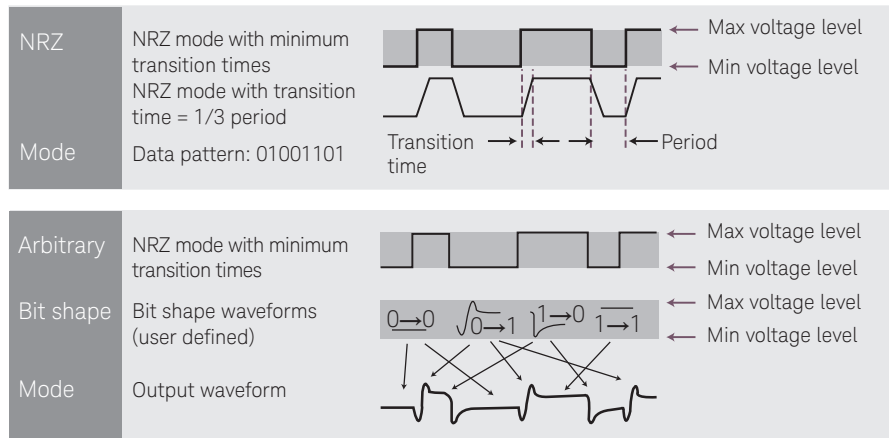

The 81150A and the 81160A pattern generators let you define the transitions from one bit to the other so that the previous bit influences the current bit. The user can set up own defined arbitrary bit shapes.

PRBS

In addition to user-defined patterns, standard patterns like PRBS up to 231 are available.

Sequencer

The sequencer allows setting up a pre-amble sequence so that the device under test moves into test mode.

2-, 3- and 4-level signals

Additionally to 2-level signals, it is also possible to create 3- and even 4-level signals. With the 3-level signals, it is no longer necessary to add different signals for electrical idle. 3-level signals are important e.g. for use in Ethernet environment and 4-level signals e.g. for PAM-4 applications.

Bit and block trigger mode

Besides, standard trigger modes like continuous bit and block trigger modes allow adoptions to application needs. In the bit mode you see that on every trigger, the sequence is advanced by one bit. An application example is a bit clock, which can be fed into an external clock and then into the trigger input.

In the block mode the entire data block is generated once per trigger event. This is interesting for example in applications with protocol data.

Pass through pattern for combined physical and protocol test up to 10 Mbit/s

The 81150A and the 81160A pattern generators pass the data through to the device under test and add any kind of stress (shape and timing change).

Bridge the gap between protocol and physical layer test – in real time up to 10 Mbit/s

Increase your test efficiency by combining physical layer test with protocol test

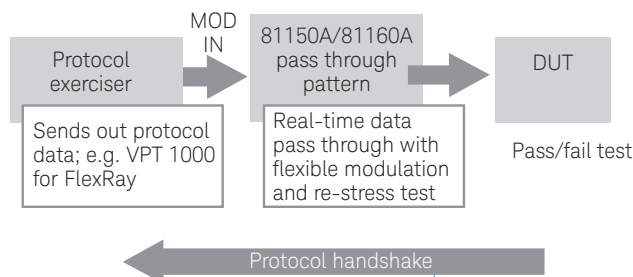

The pass-through pattern functionality takes the protocol data via Mod In and adds any kind of stress (shape and timing changes).

Modulation

Modulation of the pattern signal enables you to emulate real-world conditions.

AM – amplitude of the pattern signal is multiplied by the modulation signal to emulate level distortions of the data signal e.g. sinusoidal interference.

FM – frequency of the pattern signal is modulated to emulate SSC on the data signal.

PM – the phase of the data bits is modulated to emulate jitter on the data signal.

Connectivity

Filling the arbitrary memory easily

There are several possibilities for filling the arbitrary memory. There are 6 built-in, standard arbitrary waveforms, but you can also create any waveform you need, either on the instrument or on a PC, using the Keysight 33503A BenchLink Waveform Builder Pro software available for the 81150A and 81160A Pulse Function Arbitrary Noise Generators. The 33503A software is being designed for waveform creation, waveform import from Keysight scopes and waveform download to the 81150A and 81160A generators.

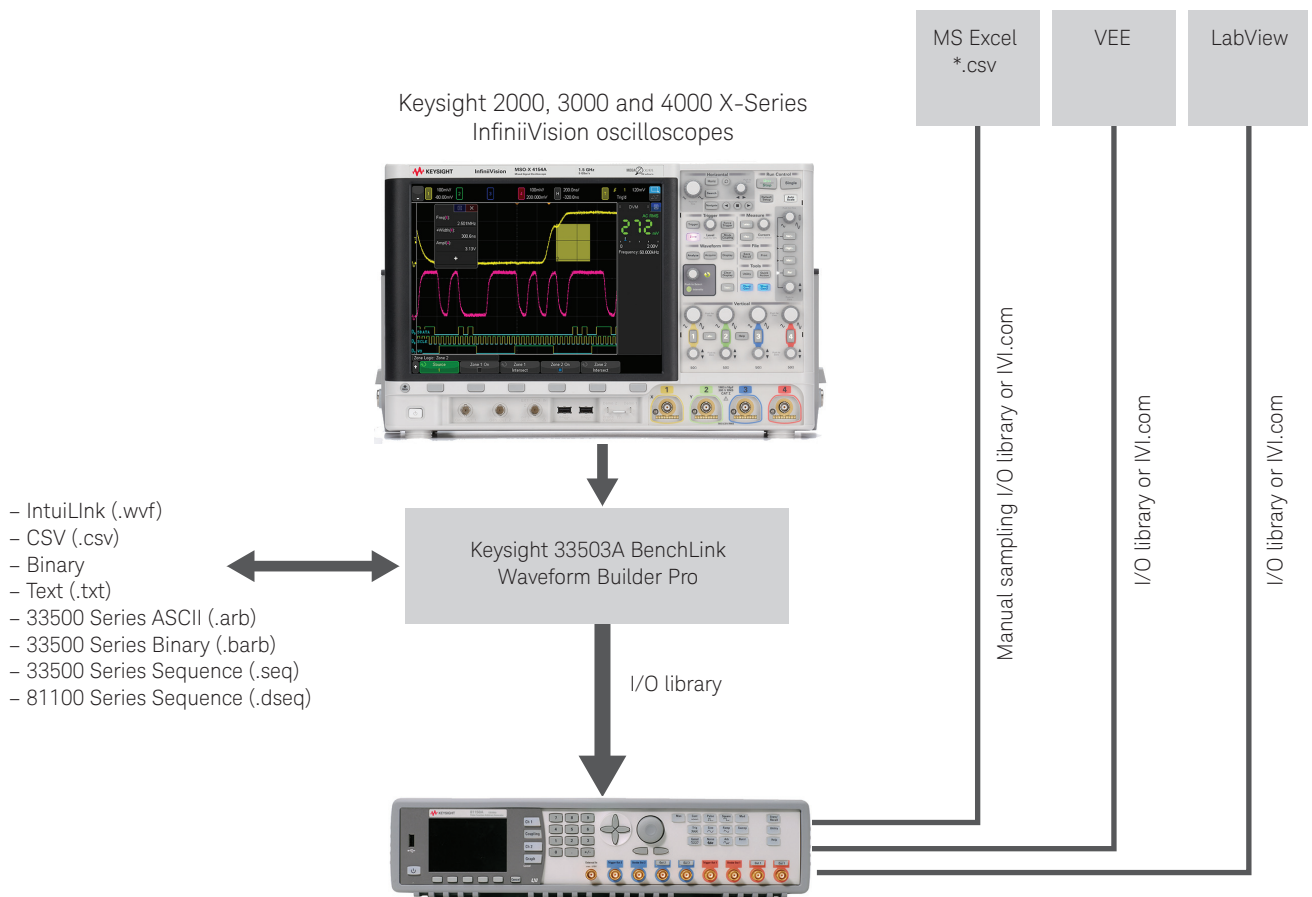

Measurement – Anywhere and Anytime

The web interface allows you to use the full functionality and feature set of the Keysight 81150A and 81160A Pulse Function Arbitrary Noise Generators from a web browser.

Channel 1: set up the signal

Web interface

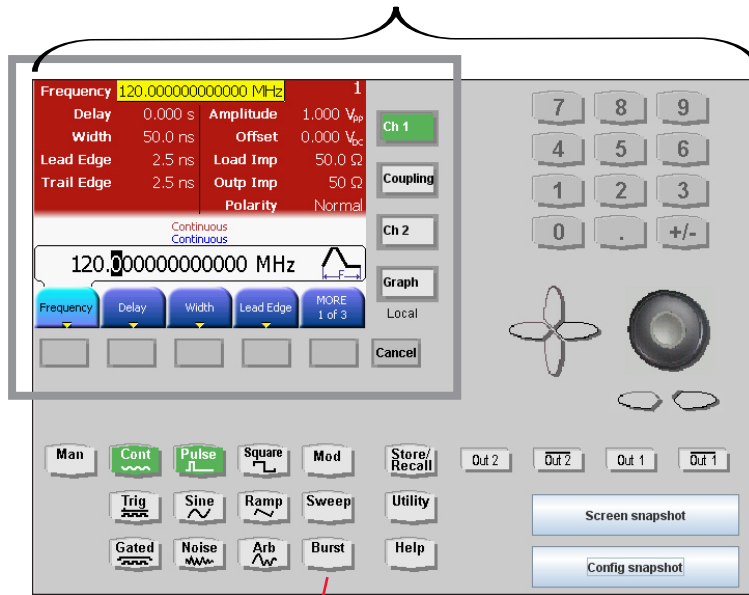

Just decide on the waveform

Channel 2: add noise

Web interface

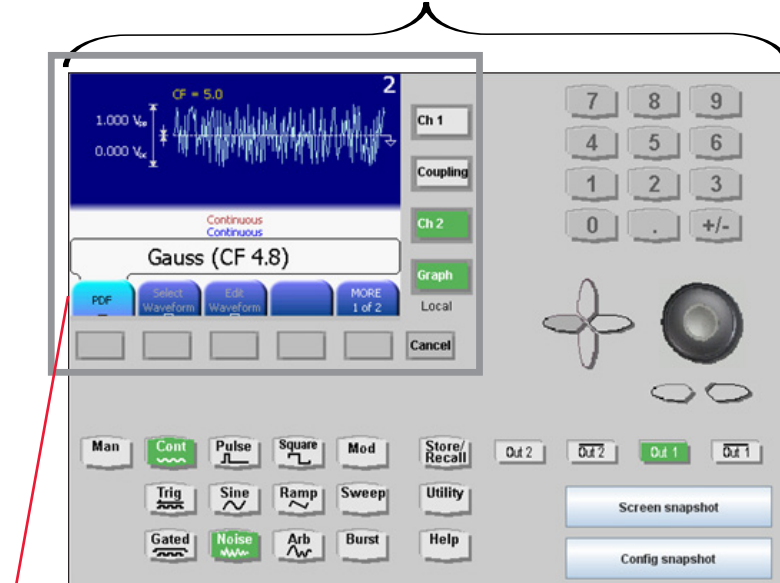

Choose the crest factor/probability function you need

Amplifier concept

Different applications and devices call for different bandwidth and voltage levels. Choose the performance you need.

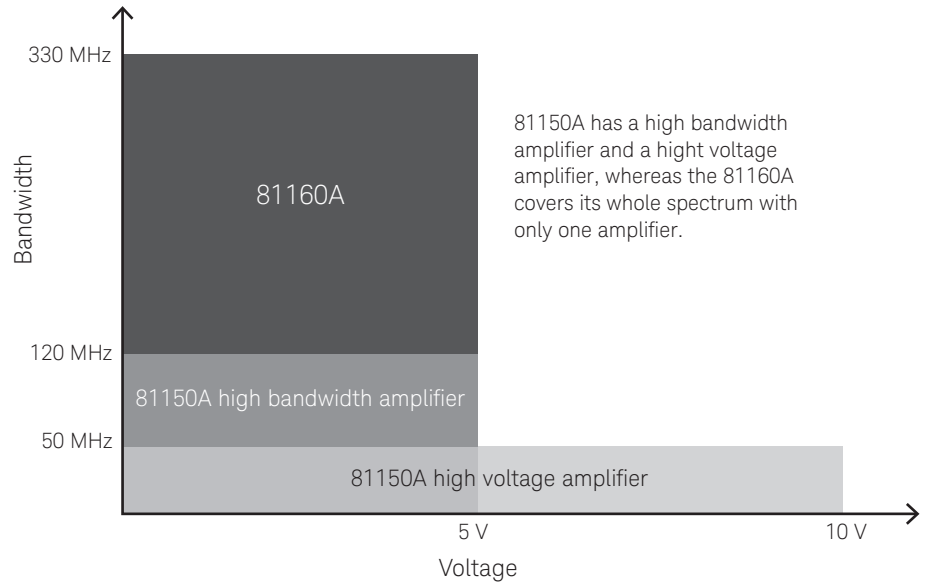

Flexible signal synchronization

The 81150A has one trigger output and one strobe output per channel.



81160A: Sync Out A and B

The 81160A generates the trigger signal and the strobe signal per channel internally. Using a fully configurable switch matrix, two of the four internal signals can be routed to Sync Out A or Sync Out B.

Modes of Operation

There are four components to the mode of operation:

- Coupling between channels
- Trigger mode
- Waveform type
- Advanced modes

Coupling between channel 1 and 2

The two-channel version has two distinct modes of operation:

- Coupling off: The two channels operate independently. Frequency generation for both channels is based on the same clock reference, but can be selected independently.
- Coupling on: The frequency, trigger mode, waveform type and advanced mode are identical for both channels. The fix delay of channel 1 and channel 2 is the same.

Trigger modes

- Continuous: Continuous waveform, burst, sweep or modulation. The external In is not used in continuous mode.
- Externally triggered: Each active transition at the external In (rising, falling or both) generates a single waveform, burst or sweep.
- Externally gated: The active level (high or low) at the external In enables waveforms, bursts or sweeps. The last waveform, burst or sweep is always completed.
- Internally triggered: The internal clock replaces the external trigger source. This can be applied for waveform, burst, or sweep.
- Manual: This generates a single trigger. The source is either a button on the front panel or a remote command.

Trigger rate (internally triggered)

81150A: 1 μ Hz to 120 MHz

81160A: 1 μ Hz to 330 MHz

Trigger rate (externally triggered)

81150A: DC to 120 MHz

81160A: DC to 330 MHz

Waveform Types

- Standard waveforms: pulse, sine, square, ramp, noise, arbitrary
- Predefined arbitrary waveforms: exponential rise, exponential fall, $\sin(x)/x$, cardiac and DC
- Pulse, sine, ramp, noise and arbitrary measured with 50 Ω source impedance into 50 Ω load impedance.

Pulse characteristics

	81150A	81160A
Frequency range		
High bandwidth amplifier	1 μ Hz to 120 MHz	1 μ Hz to 330 MHz
High voltage amplifier	1 μ Hz to 50 MHz	
Frequency resolution		
	1 μ Hz	1 μ Hz
Pulse width		
Range	4.1 ns to (period - 4.1 ns) typ. 10 ns to (period - 10 ns)	1.5 ns to (period - 1.5 ns) spec.
High bandwidth amplifier	10 ns to (period - 10 ns)	
High voltage amplifier	100 ps, 6 digits	100 ps, 6 digits
Resolution	± 500 ps ± 50 ppm	± 300 ps ± 50 ppm
Accuracy		
Transition time (independent rise and fall)		
Range		
High bandwidth amplifier	2.5 ns to 1000 s (10% to 90%)	1.0 ns to 1000 s (10% to 90%)
High voltage amplifier	7.5 ns to 1000 s (10% to 90%)	
Resolution	100 ps, 6 digits	100 ps, 6 digits
Accuracy		
High bandwidth amplifier	± 500 ps ± 50 ppm	± 300 ps ± 50 ppm
High voltage amplifier	-1000 ps to +500 ps ± 50 ppm	
Overshoot		
	2% typ. ¹	4% typ. ²

1. Overshoot disappears for transition times > 5 ns (high bandwidth amplifier) and > 15 ns (high voltage amplifier).

2. Overshoot disappears for transition times > 2 ns.

Sine characteristics

	81150A			81160A		
Frequency range						
High bandwidth amplifier	1 μ Hz to 240 MHz			1 μ Hz to 500 MHz		
High voltage amplifier	1 μ Hz to 50 MHz					
Frequency resolution						
	1 μ Hz			1 μ Hz		
Harmonic distortion (High bandwidth amplifier 50 Ω into 50 Ω)						
		1 V_{PP}	3 V_{PP}		1 V_{PP}	3 V_{PP}
1 μ Hz to 2 MHz	< -62 dBc spec.	< -62 dBc spec.		1 μ Hz to 2 MHz	< -65 dBc spec.	< -63 dBc spec.
2 MHz to 10 MHz	< -57 dBc spec.	< -52 dBc spec.		2 MHz to 10 MHz	< -62 dBc spec.	< -53 dBc spec.
10 MHz to 35 MHz	< -45 dBc spec.	< -40 dBc spec.		10 MHz to 50 MHz	< -50 dBc spec.	< -40 dBc spec.
35 MHz to 70 MHz	< -35 dBc spec.	< -30 dBc spec.		50 MHz to 200 MHz	< -30 dBc spec.	< -27 dBc spec.
70 MHz to 240 MHz	< -22 dBc spec.	< -17 dBc spec.		200 MHz to 500 MHz	< -22 dBc spec.	< -20 dBc spec.
Harmonic distortion (High voltage amplifier 50 Ω into 50 Ω)						
		10 V_{PP}				
1 μ Hz to 8 MHz	< -40 dBc					
8 MHz to 50 MHz	< -25 dBc					
Non-harmonic (spurious) distortion						
1 μ Hz to 20 MHz	-60 dBc typ.			1 μ Hz to 1 MHz	-50 dBc typ.	
20 MHz to 200 MHz	-55 dBc typ.			1 MHz to 10 MHz	-55 dBc typ.	
200 MHz to 240 MHz	-50 dBc typ.			10 MHz to 280 MHz	-50 dBc typ.	
				280 MHz to 330 MHz	-45 dBc typ.	
				330 MHz to 500 MHz	-43 dBc typ.	
SSB phase noise (10 kHz offset)						
1 MHz	-119 dBc/Hz typ.			1 MHz	-115 dBc/Hz typ.	
10 MHz	-115 dBc/Hz typ.			10 MHz	-115 dBc/Hz typ.	
100 MHz	–			100 MHz	-110 dBc/Hz typ.	
240 MHz	-93 dBc/Hz typ.			240 MHz	–	
500 MHz	–			500 MHz	-100 dBc/Hz typ.	

Square characteristics

	81150A	81160A
Frequency range		
High bandwidth amplifier	1 μ Hz to 120 MHz	1 μ Hz to 330 MHz
High voltage amplifier	1 μ Hz to 50 MHz	
Frequency resolution	1 μ Hz	1 μ Hz
Duty cycle		
High bandwidth amplifier	(Freq/240 MHz) to 1 – (Freq/240 MHz) e.g. 60 MHz; 25% to 75%	(Freq/ 660 MHz) to 1 – (Freq/ 660 MHz) e.g. 115 MHz; 25% to 75% e.g. 3.3 MHz; 0.5% to 99.5%
High voltage amplifier	(Freq/100 MHz) to 1 – (Freq/100 MHz) e.g. 1 MHz 1% to 99%	
Resolution	0.1%	0.1%
Transition time (10% to 90%)		
High bandwidth amplifier	2.5 ns typ. fixed	1.1 ns typ. fixed
High voltage amplifier	6 ns typ. fixed	
Overshoot	2% typ.	4% typ.

Ramp characteristics

	81150A	81160A
Frequency range	1 μ Hz to 5 MHz	1 μ Hz to 20 MHz
Frequency resolution	1 μ Hz	1 μ Hz
Linearity	< 0.1% (f < 10 kHz)	< 0.1% (f < 10 kHz)
Symmetry	0.0% to 100%	0.0% to 100%

Noise characteristics

	81150A	81160A
Bandwidth		
High bandwidth amplifier	120 MHz typ.	160 MHz typ.
High voltage amplifier	40 MHz typ.	
Amplitude distribution	Selectable Gaussian, user defined	Selectable Gaussian, user defined
Crest factor (peak/RMS) selectable	3.1, 4.8, 6.0, 7.0 typ. (Gaussian distribution)	3.1, 4.8, 6.0, 7.0 typ. (Gaussian distribution)
Noise type	Deterministic, triggerable	Deterministic, triggerable
Repetition time	~ 26 days	~ 20 days

Arbitrary characteristics

	81150A	81160A
DAC sample rate	2 GSa/s ¹ , fixed	2.5 GSa/s, fixed
Waveform length	2 to 512 k points	1-channel instrument: 2 to 256 k points 2-channel instrument: 2 to 128 k points
Wavelength vs. memory access rate	2 to 512 k points at memory access rate 1,000 MSa/s ¹	1-channel instrument, automatic selection: 128 k to 256 k points at memory access rate 625 MSa/s ² 64 k to 128 k points at memory access rate 1,250 MSa/s ³ 2 to 64 k points at memory access rate 2,500 MSa/s 2-channel instrument, automatic selection: 64 k to 128 k points at memory access rate 625 MSa/s ² 32 to 64 k points at memory access rate 1,250 MSa/s ³ 2 to 32 k points at memory access rate 2,500 MSa/s
DAC resolution	14 bits	14 bits
Frequency range	1 μ Hz to 120 MHz	1 μ Hz to 330 MHz
Frequency resolution	1 μ Hz	1 μ Hz
Transition time (10% to 90%)		
High bandwidth amplifier	1.7 ns typ.	1.0 ns typ.
High voltage amplifier	5 ns typ.	
Filter bandwidth		
High bandwidth amplifier	240 MHz typ.	500 MHz typ.
High voltage amplifier	80 MHz typ.	
PP jitter	1 ns typ.	400 ps typ. at memory sample rate 2,500 MSa/s

1. One step linear interpolation between two memory samples. DAC clock rate is 2,000 MSa/s.
2. Three steps linear interpolation between two memory samples. DAC clock rate is 2,500 MSa/s.
3. One step linear interpolation between two memory samples. DAC clock rate is 2,500 MSa/s

Advanced Modes

Three advanced modes exist:

- Modulation: selects the modulation type: AM, FM, PM, FSK, PWM
- Sweep: for frequency sweeps
- Bursts: repeats selected waveform n times

Modulation

A modulation input (for AM, FM, PM, FSK, PWM) for each channel is provided on the back-panel. In the two-channel instrument one channel can also modulate the other channel.

Modulation In 1/modulation In 2

	81150A	81160A
Input range (full scale)	Selectable ± 2.5 V or ± 5 V	± 2.5 V
Frequency range	DC to 10 MHz	DC to 10 MHz
Input impedance	Selectable 10 k Ω , 50 Ω nom.	Selectable 10 k Ω , 50 Ω nom.
Connector	BNC, back panel	BNC, back panel

AM

	81150A	81160A
Carrier waveforms	Sine, square, ramp, arbitrary	Sine, square, ramp, arbitrary
Internal modulation	Sine, square, ramp (up, 50%, down), noise, arbitrary	Sine, square, ramp (up, 50%, down), noise, arbitrary
Modulation frequency		
Internal	1 mHz to 10 MHz	1 mHz to 50 MHz
External	DC to 10 MHz	DC to 10 MHz
Depth	0% to 120%	0% to 120%
Double-sideband suppressed carrier	Selectable on/off	Selectable on/off
Source	Internal, external, channel	Internal, external, channel

FM

	81150A	81160A
Carrier waveforms	Sine, square, ramp, arbitrary	Sine, square, ramp, arbitrary
Internal modulation	Sine, square, ramp (up, 50%, down), noise, arbitrary	Sine, square, ramp (up, 50%, down), noise, arbitrary
Modulation frequency		
Internal	1 mHz to 10 MHz	1 mHz to 50 MHz
External	DC to 10 MHz	DC to 10 MHz
Deviation range	1 μ Hz to 240 MHz ¹	1 μ Hz to 500 MHz ¹
Source	Internal, external, channel	Internal, external, channel

PM

	81150A	81160A
Carrier waveforms	Sine, square, ramp, arbitrary	Sine, square, ramp, arbitrary
Internal modulation	Sine, square, ramp (up, 50%, down), noise, arbitrary	Sine, square, ramp (up, 50%, down), noise, arbitrary
Modulation frequency		
Internal	1 mHz to 10 MHz	1 mHz to 50 MHz
External	DC to 10 MHz	DC to 10 MHz
Deviation range	0 to 360°	0 to 360°
Source	Internal, external, channel	Internal, external, channel

1. Max frequency depends on selected waveform.

FSK

	81150A	81160A
Carrier waveforms	Sine, square, ramp, arbitrary	Sine, square, ramp, arbitrary
Internal modulation	50% square	50% square
FSK rate		
Internal	1 MHz to 50 MHz	1 MHz to 50 MHz
External	1 MHz to 10 MHz	1 MHz to 10 MHz
Frequency range	1 MHz to 240 MHz ^{1,2}	1 MHz to 500 MHz ¹
Source	Internal, external, channel	Internal, external, channel

1. Max frequency depends on selected waveform.

2. For export control: Effective switching time is 40 ns.

PWM

	81150A	81160A
Carrier waveform	Pulse	Pulse
Internal modulation	Sine, square, ramp (up, 50%, down), noise, arbitrary	Sine, square, ramp (up, 50%, down), noise, arbitrary
Modulation frequency		
Internal	1 MHz to 10 MHz	1 MHz to 50 MHz
External	DC to 10 MHz	DC to 10 MHz
Deviation range	0% to 100% of pulse width	0% to 100% of pulse width
Source	Internal, external, channel	Internal, external, channel

Sweep

An independent frequency sweep is provided for each channel.

	81150A	81160A
Waveforms	Pulse, sine, square, ramp, triangle, arbitrary	Pulse, sine, square, ramp, triangle, arbitrary
Type	Linear or logarithmic	Linear or logarithmic
Direction	Up or down	Up or down
Sweep time	100 μ s to 500 s	50 μ s to 500 s
Start frequency/stop frequency	1 μ s to 240 MHz ³	1 μ Hz to 500 MHz ¹
Amplitude flatness (relative to 1 kHz, 2 V _{pp})	–	1 μ Hz to 500 MHz \pm 0.5 dB typ.
Trigger source	External, internal, manual	External, internal, manual
Marker	Frequency marker	Frequency marker

3. Max frequency depends on selected waveform.

Burst

An independent burst capability is provided for each channel.

	81150A	81160A
Waveforms	Pulse, sine, square, ramp, triangle, arbitrary	Pulse, sine, square, ramp, triangle, arbitrary
Frequency	1 μ Hz to 120 MHz	1 μ Hz to 330 MHz
Modes	Externally triggered, internally triggered, externally gated	Externally triggered, internally triggered, externally gated
# of waveforms in a burst	2 to 2 ³¹ - 1 (~ 2 billion)	2 to 2 ³¹ - 1 (~ 2 billion)
Trigger period	16.7 ns to 9999 s	6.1 ns to 9999s
Start phase ⁴	-360 to +360°	-360 to +360°
Gate source	External	External
Trigger source	External, internal, manual	External, internal, manual

4. Available for all waveforms except pulse, square and ramp.

Outputs

Main outputs

A selectable single-ended or differential output is provided for each channel on the front-panel.

Max. frequency

	81150A	81160A
High bandwidth amplifier	120 MHz pulse/240 MHz sine	330 MHz pulse/500 MHz sine
High voltage amplifier	50 MHz	

Out 1/Out 2

	81150A	81160A
Output type	Single-ended or differential	Single-ended or differential
Amplitude (50 Ω into 50 Ω)		
High bandwidth amplifier		
1 μ Hz to 120 MHz	50 mV _{pp} to 5 V _{pp} ¹ typ.	
120 MHz to 240 MHz	50 mV _{pp} to 3 V _{pp} ¹ typ.	
1 μ Hz to 330 MHz		50 mV _{pp} to 5 V _{pp} ¹ typ.
330 MHz to 500 MHz		50 mV _{pp} to 3 V _{pp} ¹ typ.
High voltage amplifier		
1 μ Hz to 50 MHz	100 mV _{pp} to 10 V _{pp} ¹ typ.	
Amplitude (50 Ω into open, 5 Ω into 50 Ω)		
High bandwidth amplifier		
1 μ Hz to 120 MHz	100 mV _{pp} to 10 V _{pp} ¹ (to 9 V _{pp} ²) typ.	
120 MHz to 240 MHz	100 mV _{pp} to 5 V _{pp} ¹ typ.	
1 μ Hz to 60 MHz		100 mV _{pp} to 10 V _{pp} ^{1,4} typ.
High voltage amplifier		
1 μ Hz to 50 MHz	200 mV _{pp} to 20 V _{pp} ¹ typ.	
DC amplitude accuracy	\pm (1.5% of setting + 5 mV)	\pm (1.5% of setting + 5 mV)
Voltage window (50 Ω into 50 Ω)		
High bandwidth amplifier	-5 V to +5 V typ.	-5 V to +5 V typ.
High voltage amplifier	-10 V to +10 V typ.	
Voltage window (50 Ω into open, 5 Ω into 50 Ω)		
High bandwidth amplifier	-10 V to +10 V ¹ (-9 V to +9 V ²) typ.	-10 V to +10 V typ. ⁴
High voltage amplifier	-20 V to +20 V typ.	
DC offset accuracy		
\pm 5 V voltage window	\pm (25 mV + 1%)	\pm (25 mV + 1%)
\pm 10 V voltage window	\pm (50 mV + 1%)	\pm (50 mV + 1%)
\pm 20 V voltage window	\pm (75 mV + 1%)	
Resolution	1 mV, 4 digits	1 mV, 4 digits
Output impedance	Selectable 50 Ω / 5 Ω nom.	50 Ω nom.
Variable load impedance	0.3 Ω to 1 M Ω ³	0.1 Ω to 1 M Ω
Protection	Short-circuit protected, overload disables main output	Short-circuit protected, overload disables main output
Connector	BNC, front panel	BNC, front panel

1. All amplitudes are single-ended amplitudes. Differential peak-peak amplitudes are twice the single-ended value.

2. 10 V_{pp} for 50 Ω into open; 9 V_{pp} for 5 Ω into 50 Ω .

3. Current of normal Out plus current of complement Out is limited to 440 mA per channel.

4. Only for 50 Ω into open.

Clock Reference

External reference output

	81150A	81160A
Frequency	10 MHz typ.	10 MHz spec.
Accuracy	± 50 ppm	± 10 ppm
Stability	± 2 ppm, 0 to 50 °C	± 2 ppm, 0 to 55 °C
Aging	± 1 ppm per year	± 1 ppm per year
Output level	1 V nom.	1 V nom.
Impedance	50 Ω nom., AC coupled	50 Ω nom., AC coupled
Connector	BNC, rear panel	BNC, rear panel

External reference input

	81150A	81160A
Lock range	10 MHz ± 500 ppm	10 MHz ± 500 ppm typ.
Input level	200 mV _{pp} to 5 V _{pp}	200 mV _{pp} to 5 V _{pp} typ.
Impedance	1 kΩ nom., AC coupled	1 kΩ nom., AC coupled
Connector	BNC, rear panel	BNC, rear panel

Internal frequency characteristics

	81150A	81160A
Accuracy	± 50 ppm	±10 ppm
Stability	± 2 ppm, 0 to 50 °C	± 2 ppm, 0 to 55 °C
Aging	± 1 ppm per year	± 1 ppm per year

External Input

A common external input is provided for both channels on the front panel. The external input is used for external trigger or external gate modes.

	81150A	81160A
Frequency range	DC to 120 MHz	DC to 330 MHz
Input range	-10 V to +10 V	-5 V to +5 V
Maximum input amplitude	10 V _{pp}	10 V _{pp}
Input sensitivity	200 mV _{pp}	Hysteresis low: 200 mV _{pp} Hysteresis high: 350 mV _{pp}
Threshold		
Range	-10 V to 10 V	-5 V to +5 V
Resolution	100 mV	100 mV
Impedance	Selectable 10 kΩ/50 Ω, DC coupled	Selectable, 1 kΩ/50 Ω, DC coupled
Slope	Selectable, rising/falling/both	Selectable, rising/falling/both
Pulse width	> 3.3 ns	> 1.3 ns
Transition time	< 100 ns	
Connector	BNC, front panel	BNC, front panel

Frequency counter

The frequency applied to external input is measured

Gate time, up to 330 MHz	–	1 s, fix
Accuracy	–	See clock reference specifications

81150A Trigger Outputs

For 81150A, a separate trigger output is provided for each channel on the front-panel.

In advanced mode internally/externally modulated (AM, FM, PM, PWM), the trigger output has the frequency of the unmodulated carrier waveform, with a 50% duty cycle.

For FSK modulation, the trigger output has the same frequency as the data output. That is, it alternates between the two frequencies.

If noise is selected, a trigger signal is generated when noise is restarted internally, externally or manually.

For all other modes of operation the trigger signal (TRIGGER OUT) marks the start of each waveform period.

81150A Trigger Out 1/Trigger Out 2

81150A	
Output level	Selectable TTL/ECL
TTL	0 V/2.5 V nom.
ECL	-0.85 V/-1.80 V nom.
Pulse width	
Internally triggered, continuous	50% duty cycle typ.
Externally triggered	4 ns typ.
Transition time (20% to 80%)	2.0 ns typ.
Maximum rate	120 MHz ¹
Impedance	50 Ω nom.
Connector	BNC, front panel

1. For output frequencies > 120 MHz, the trigger rate is $\frac{1}{4}$ of the output frequency. If a frequency sweep or a FSK frequency exceeds 120 MHz, the trigger rate is $\frac{1}{4}$ of the output frequency.

81150A Strobe Outputs

A strobe output is provided for each channel on the front-panel of pulse generator 81150A. The strobe output signal has a different function, depending on the mode of operation.

If no advanced mode is selected, the strobe output is a constant low.

In advanced mode internally/ externally triggered or gated burst, the strobe output provides a signal indicating the duration of a burst. The rising edge of the strobe signal is synchronized to the start of the first waveform period in a burst. The falling edge is synchronized to the start of the last waveform period in the burst.

In advanced mode sweep with the frequency marker off, the strobe output is a pulse with half the duration of the sweep. The strobe signal goes high at the beginning of the sweep.

In advanced mode sweep with the frequency marker on, the strobe output goes high at the beginning of the sweep and goes low at the marker frequency.

In pattern mode (block mode = On), the strobe output goes high at the beginning of the pattern and goes low at the last bit of the pattern. Refer to the User Guide for more details.

In advanced mode internally/externally modulated (AM, FM, FSK, PM, PWM), the strobe output is the analog modulation waveform.

In pattern mode (block mode = On), the logical strobe signal goes high at the beginning of the pattern and goes low at the last bit of the pattern. Refer to the User Guide for more details.

81150A Strobe Out 1/Strobe Out 2

81150A	
Digital output level	Selectable TTL/ECL
TTL	0 V/2.5 V nom.
ECL	-0.85 V/-1.80 V nom.
Analog output level (modulator)	-2.0 V to 2.0 V (full scale)
Impedance	50 Ω nom.
Connector	BNC, front panel
Min pulse width	4 ns typ.
Transition time (20% to 80%)	2.0 ns typ.

81160A Trigger and Strobe Outputs Sync Out A and Sync Out B

For the one-channel instrument as well as the two-channel instrument two high speed outputs Sync Out A and Sync Out B are provided at the front panel. The Sync output signals can be configured very flexibly by an internal switch matrix to output the logical Trigger Out functionality or Strobe Out functionality according to the following switch matrix.

1-channel instrument

81160A	
Sync Out A source	None, logical trigger signal 1, logical strobe signal 1
Sync Out B source	None, logical trigger signal 1, logical strobe signal 1

It is e.g. possible, that the logical trigger signal 1 functionality is routed simultaneously to Sync.

2-channel instrument

81160A	
Sync Out A source	None, logical trigger signal 1, logical strobe signal 1, logical trigger signal 2, logical strobe signal 2
Sync Out B source	None, logical trigger signal 1, logical strobe signal 1, logical trigger signal 2, logical strobe signal 2

It is e.g. possible, that the logical trigger signal 1 functionality is routed simultaneously to Sync.

Sync Out A/Sync Out B

81160A	
Digital output level	Selectable TTL, ECL
TTL	0 V/2.5 V nom.
ECL	-0.85 V/-1.80 V nom.
Analog output level (modulator)	-2.0 V to 2.0 V (full scale), Available, if routed to logical Strobe Out
Impedance	50 Ω nom.
Transition time	0.8 ns typ. (20%/80%)
Connector	BNC, front panel

The logical trigger output and logical strobe output functionality is described below.

Logical trigger signal

The logical trigger signal is an internally generated signal that can be routed to the BNC connector of Sync Out A or Sync Out B. For the two-channel instrument, the logical trigger signal is generated for both, channel 1 and channel 2.

In advanced mode internally/externally modulated (AM, FM, PM, PWM), the logical trigger signal has the frequency of the unmodulated carrier waveform with 50% duty cycle.

For FSK modulation the logical trigger signal generates the same frequency as the data output – it alternates between the two frequencies.

If noise is selected, a trigger signal is generated when noise is restarted internally, externally or manually.

For all other modes of operation the logical trigger signal marks the start of each waveform period.

Logical trigger signal 1/logical trigger signal 2

81160A	
Pulse width	
Internally triggered, continuous	50% duty cycle typ.
Externally triggered	1.5 ns typ.
Maximum rate	330 MHz ¹

1. For output frequencies > 330 MHz, the trigger rate is ½ of the output frequency. In pattern mode with bit rate > 330 MBit/s, the trigger rate is ½ of the output frequency. If a frequency sweep or a FSK frequency exceeds 330 MHz, the trigger rate is ½ of the output frequency.

Logical strobe signal

The logical strobe signal is an internally generated signal that can be routed to the BNC connector of Sync Out A or Sync Out B. For the two-channel instrument, the logical strobe signal is generated for both, channel 1 and channel 2.

The logical strobe signal has a different function, depending on the mode of operation. If no advanced mode is selected, the logical strobe signal is constant low.

In advanced mode internally/ externally triggered or gated burst, the logical strobe signal provides a signal indicating the duration of a burst. The rising edge of the logical strobe signal is synchronized to the start of the first waveform period in a burst. The falling edge is synchronized to the start of the last waveform period in the burst.

In advanced mode sweep with the frequency marker off, the logical strobe signal is a pulse with half of the duration of the sweep. The strobe signal goes high at the beginning of the sweep.

In advanced mode sweep with the frequency marker on, the logical strobe signal goes high at the beginning of the sweep and goes low at the marker frequency.

In advanced mode internally/externally modulated (AM, FM, FSK, PM, PWM), the logical strobe signal is the analog modulation waveform.

In pattern mode (block mode = On), the logical strobe signal goes high at the beginning of the pattern and goes low at the last bit of the pattern. Refer to the User Guide for more details.

Digital Channel Addition

If the instrument is equipped with two output channels, channel 2 can be added to channel 1 internally. The maximum output voltage of channel 1 remains unchanged. If channel addition is selected, channel 2 outputs the unchanged waveform of channel 2.

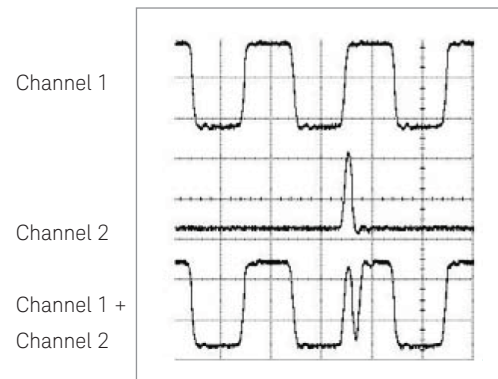
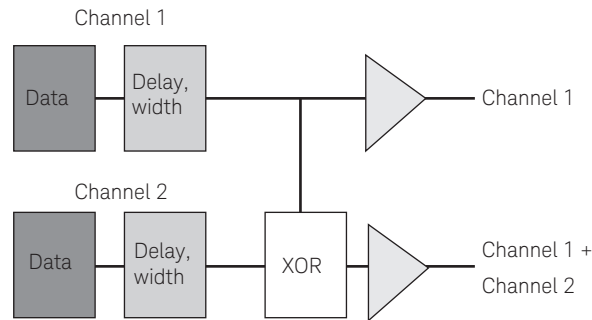

Timing Characteristics

External In timing characteristics

	81150A	81160A
Delay: External In to Main Out 1, 2		
Fix delay		
Advance mode: off, burst	366 ns typ.	404 ns typ.
Advanced mode: sweep	350 ns typ.	404 ns typ.
Pattern mode: on Variable delay ¹	406 ns typ.	404 ns typ.
Range	Independent for Out 1, Out 2	Independent for Out 1, Out 2
Resolution	0 s to 1000 s ²	0 s to 1000 s ²
Accuracy	1 ps, 6 digits ± 25 ps ± 50 ppm	1 ps, 6 digits ± 35 ps ± 50 ppm
Delay	External In to Trigger Out 1, 2	External In to Sync Out A, B
Fix delay		
Advanced mode: off, burst	366 ns typ.	404 ns typ.
Advanced mode: sweep	350 ns typ.	404 ns typ.
Pattern mode: on	406 ns typ.	404 ns typ.
Jitter ³		
External In to Main Out 1, 2	15 ps RMS typ.	15 ps RMS typ.
External In to Trigger Out 1, 2	15 ps RMS typ.	–
External In to Strobe Out 1, 2	15 ps RMS typ.	–
External In to Sync Out A, B	–	15 ps RMS typ.

1. Not available, if sweep or modulation is selected

2. Trigger period ≥ variable delay

3. External In amplitude > 500 mV. External In transition time < 10 ns. Valid for externally triggered pulse, square, sine, ramp, arb. Externally triggered noise or externally triggered sweep has peak-peak jitter of 8 ns for the 81150A and 3.2 ns for the 81160A, measured with 50 Ω source impedance at main output.

Continuous or internally triggered timing characteristics

	81150A	81160A
Delay	Trigger Out 1, 2 to Main Out 1, 2	Sync Out A, B to Main Out 1, 2
Fix delay	0 ns typ.	0 ns typ.
Variable delay Out 1, 2 ¹	Independent for Out 1, Out 2	Independent for Out 1, Out 2
Range in continuous mode ²	0 to 1 waveform period	0 to 1 waveform period
Range in internally triggered mode ³	0 s to 1000 s typ.	0 s to 1000 s spec.
Resolution	1 ps, 6 digits	1 ps, 6 digits
Accuracy	± 25 ps ± 50 ppm	± 35 ps ± 50 ppm
Delay	Trigger Out 1, 2 to Strobe Out 1, 2	Sync Out A to Sync Out B
Advanced mode: burst	0 ns typ.	0 ns typ.
Jitter ⁴	Jitter Main Out 1, 2 to Main Out 1, 2: 7 ps RMS typ. Trigger Out 1, 2 to Main Out 1, 2: 8 ps RMS typ. Trigger Out 1, 2 to Strobe Out 1, 2: 9 ps RMS typ. Trigger Out 1, 2 to Trigger Out 1, 2: 9 ps RMS typ.	Jitter Main Out 1, 2 to Main Out 1, 2: 7 ps RMS typ. Sync Out A, B to Main Out 1, 2: 8 ps RMS typ. Sync Out A to Sync Out B: 9 ps RMS typ.

1. Not available, if sweep or modulation is selected.

2. Advanced mode = off or advanced mode = burst.

3. Trigger period ≥ variable delay.

4. Measured with 50 Ω source impedance at Main Out. Valid for continuous or internally triggered pulse, square, sine, ramp, arb.
Internally triggered or continuous noise or sweep has peak-peak jitter of 8 ns typ. for the 81150A and 3.2 ns for the 81160A.

Coupled mode On timing characteristics

	81150A	81160A
Delay: Main Out 1 to Main Out 2		
Fix delay	0 ns typ.	0 ns typ.
Variable delay Out 1, 2 ⁵	Independent for Out 1, Out 2	Independent for Out 1, Out 2
Range in continuous mode ⁶	0 to 1 waveform period	0 to 1 waveform period
Range in internally triggered mode ⁷	0 s to 1000 s typ.	0 s to 1000 s spec.
Resolution	1 ps, 6 digits	1 ps, 6 digits
Accuracy	± 25 ps ± 50 ppm	± 35 ps ± 50 ppm

5. Not available, if sweep or modulation is selected.

6. Advanced mode = off or advanced mode = burst.

7. Trigger period ≥ variable delay.

Pattern generator (optional)

	81150A Option PAT	81160A Option 330	81160A Option 660
Data rate	1 μ bit/s to 120 Mbit/s (with internal pattern source)	1 μ bit/s to 330 Mbit/s	1 μ bit/s to 660 Mbit/s
Pattern memory	16 Mbit with 1 bit resolution	4 Mbit for 1-channel instrument 2 Mbit per channel for 2-channel instrument	
Pattern memory resolution	1 bit		1 bit for data rate 1 μ bit/s to 330 Mbit/s 2 bits for data rate 330 Mbit/s to 660 Mbit/s
Number of levels	2, 3, or 4 (user selectable)		
Sequencing	Preamble followed by one looped data block-loop count: 1 – 10,000,000 the whole sequence can loop indefinitely or triggered		
Trigger modes	Continuous, gated, one bit per trigger event, one sequence per trigger event		
Pattern sources	Internal: PRBS –7, 9, 11, 15, 23, and 31 User-defined External: Pass through pattern mode. Pattern is applied and sampled at Modulation In. Indefinite pattern length. Up to 10 Mbit/s. Selectable automatic sampling for asynchronous operation or fix sampling for synchronous operation		
External sampling	Automatic and fix		
Pattern modulation	AM, FM, PM		
Arbitrary bit shapes	User-defined and predefined bit transitions with up to 64 arbitrary waveform points per bit transition		

Download Times

Block transfer is the fastest way to download waveforms to both the Keysight 81150A and 81160A Pulse Function Arbitrary Noise Generators.

Download times: block transfer (meas.)

	81150A			81160A		
	USB 2.0	GPIO	LAN	USB 2.0	GPIO	LAN
1 k points	31 ms typ.	35 ms typ.	35 ms typ.	23 ms typ.	44 ms typ.	27 ms typ.
8 k points	65 ms typ.	120 ms typ.	80 ms typ.	68 ms typ.	198 ms typ.	86 ms typ.
64 k points	700 ms typ.	1 s typ.	730 ms typ.	330 ms typ.	1.36 s typ.	449 ms typ.
256 k points	–	–	–	1.25 s typ.	5.4 s typ.	1.75 s typ.
512 k points	2.9 s typ.	5.2 s typ.	3.7 s typ.	–	–	–

Download times: integer comma separated values (meas.)

	81150A			81160A		
	USB 2.0	GPIO	LAN	USB 2.0	GPIO	LAN
1 k points	220 ms typ.	200 ms typ.	220 ms typ.	214 ms typ.	188 ms typ.	181 ms typ.
8 k points	1.8 s typ.	1.6 s typ.	1.4 s typ.	1.6 s typ.	1.45 s typ.	1.39 s typ.
64 k points	14.2 s typ.	12.6 s typ.	12 s typ.	13.0 s typ.	11.5 s typ.	11.0 s typ.

Download times: float comma separated values (meas.)

	81150A			81160A		
	USB 2.0	GPIO	LAN	USB 2.0	GPIO	LAN
1 k points	290 ms typ.	280 ms typ.	270 ms typ.	297 ms typ.	256 ms typ.	236 ms typ.
8 k points	2.4 s typ.	2.1 s typ.	1.9 s typ.	2.23 s typ.	1.98 s typ.	1.8 s typ.
64 k points	20 s typ.	16 s typ.	15 s typ.	18.2 s typ.	15.7 s typ.	14.3 s typ.

General Specifications

	81150A	81160A
Power supply	100 V to 240 V ~, 50 to 60 Hz 100 V to 127 V ~, 50 to 400 Hz	100 V to 240 V ~, 50 to 60 Hz 100 V to 127 V ~, 50 to 400 Hz
Power consumption	110 W nom.	90 W nom.
Operating temperature	0 to 50 °C	0 to 55 °C
Operating altitude	Up to 2000 m	Up to 2000 m
Storage temp.	-40 to 70 °C	-40 to 70 °C
Stored states	4 named user configurations and factory default	4 named user configurations and factory default
Power on state	Default or last state	Default or last state
Interface	2 x USB 2.0 standard A, 1 x USB 2.0 standard B, GPIB and LAN	2 x USB 2.0 standard A, 1 x USB 2.0 standard B, GPIB and LAN
Programming language	SCPI-1997 IEEE-488.2 LXI compliant to LXI class C (rev. 1.1)	SCPI-1997 IEEE-488.2 LXI compliant to LXI class C (rev. 1.1)
Dimensions (WxHxD)		
Bench top	439 mm x 108 mm x 456 mm	439 mm x 108 mm x 456 mm
Rack mount	428 mm x 89 mm x 439 mm	428 mm x 89 mm x 439 mm
Weight	8 kg	8 kg
Safety designed to	IEC61010-1 UL61010 CSA22.2 61010.1 certified	IEC61010-1 UL61010 CSA22.2 61010.1 certified
EMC tested to	IEC61326	IEC61326
Warm up time	30 min.	30 min.
Calibration interval	2 years recommended	2 years recommended
Warranty	3-year standard	3-year standard
Cooling requirements	When operating the instrument choose a location that provides at least 80 mm of clearance at rear, and at least 30mm of clearance at each side	When operating the instrument choose a location that provides at least 80 mm of clearance at rear, and at least 30mm of clearance at each side

Definitions

Specification (spec.)	The warranted performance of a calibrated instrument that has been stored for a minimum of 2 hours within the operating temperature range of 0 °C to 55 °C and after a 45-minute warm up period. Within ± 10 °C after autocal. All specifications include measurement uncertainty and were created in compliance with ISO-17025 and Z540 methods. Data published in this document are specifications (spec.) only where specifically indicated.
Typical (typ.)	The characteristic performance, which 80% or more of manufactured instruments will meet. This data is not warranted, does not include measurement uncertainty, and is valid only at room temperature (approximately 23 °C).
Nominal (nom.)	The mean or average characteristic performance, or the value of an attribute that is determined by design such as a connector type, physical dimension, or operating speed. This data is not warranted and is measured at room temperature (approximately 23 °C).
Measured (meas.)	An attribute measured during development for purposes of communicating the expected performance. This data is not warranted and is measured at room temperature (approximately 23 °C).
Accuracy	Represents the traceable accuracy of a specified parameter. Includes measurement error and timebase error, and calibration source uncertainty.

Available Modes of Operation

Continuous

	81150A and 81160A							
	Pulse	Square	Sine	Ramp	Noise	Arb	DC	
Advanced mode: off	Y	Y	Y	Y	Y	Y	Y	
Advanced mode: burst	Y	Y	Y	Y	N	Y	N	
Advanced mode: modulation	AM	N	Y	Y	Y	N	Y	N
	FM	N	Y	Y	Y	N	Y	N
	PM	N	Y	Y	Y	N	Y	N
	FSK	N	Y	Y	Y	N	Y	N
	PWM	Y	N	N	N	N	N	N
Advanced mode: sweep	N	Y	Y	Y	N	Y	N	

Internally triggered or externally triggered

	81150A and 81160A							
	Pulse	Square	Sine	Ramp	Noise	Arb	DC	
Advanced mode: off	Y	Y	Y	Y	Y	Y	N	
Advanced mode: burst	Y	Y	Y	Y	N	Y	N	
Advanced mode: modulation	AM	N	N	N	N	N	N	
	FM	N	N	N	N	N	N	
	PM	N	N	N	N	N	N	
	FSK	N	N	N	N	N	N	
	PWM	N	N	N	N	N	N	
Advanced mode: sweep	N	Y	Y	Y	N	Y	N	

Gated

	81150A and 81160A							
	Pulse	Square	Sine	Ramp	Noise	Arb	DC	
Advanced mode: off	Y	Y	Y	Y	Y	Y	N	
Advanced mode: burst	Y	Y	Y	Y	N	Y	N	
Advanced mode: modulation	AM	N	N	N	N	N	N	
	FM	N	N	N	N	N	N	
	PM	N	N	N	N	N	N	
	FSK	N	N	N	N	N	N	
	PWM	N	N	N	N	N	N	
Advanced mode: sweep	N	Y	Y	Y	N	Y	N	

Ordering Information for

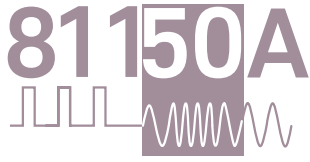

Keysight 81150A

#001	1-channel pulse function arbitrary noise generator
#002	2-channel pulse function arbitrary noise generator
#1A7	ISO17025 calibration documents
#Z54	Z540.3 calibration documents
#PAT	License for 120 Mbit/s pattern generator

Accessories included

- Certificate of calibration
- Local power cord
- USB cable
- Product CD
(User Guide, Getting Started Guide, IVI-COM driver, examples for remote access)

Optional accessories

#DOC	Printed documentation. Includes printed Getting Started Guide and printed User Guide
#1CP	Rack mount kit
#R-51B-001-5Z	Additional 2 years warranty (5 years total)

Upgrades for 81150A, 81150AU

#PAT	License for pattern generator
#DOC	Printed documentation
#EHD	Fixture for 100 Mbit Ethernet and HDMI 1.4

Ordering Information for

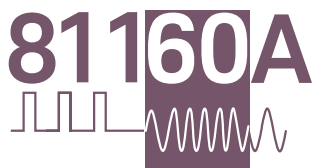

Keysight 81160A

#001	1-channel pulse function arbitrary noise generator
#002	2-channel pulse function arbitrary noise generator
#1A7	ISO17025 calibration documents
#Z54	Z540.3 calibration documents
#330	License for 330 Mbit/s pattern generator
#660	License for 660 Mbit/s pattern generator

Accessories included

- Certificate of calibration
- Local power cord
- USB cable
- Product CD
(User Guide, Getting Started Guide, IVI-COM driver, examples for remote access)

Optional accessories

#DOC	Printed documentation. Includes printed Getting Started Guide and printed User Guide
#1CP	Rack mount kit
#R-51B-001-5Z	Additional 2 years warranty (5 years total)

Upgrades for 81160A, 81160AU

#330	License for 330 Mbit/s pattern generator
#660	License for 660 Mbit/s pattern generator
#326	License for upgrade from 330 Mbit/s to 660 Mbit/s pattern generator
#DOC	Printed documentation

Literature title	Publication number
Pulse Pattern and Data Generators, Brochure	5980-0489E
81150A and 81160A Pulse Function Arbitrary Noise Generator, Demo Guide	5989-7718EN
81150A Pulse Function Arbitrary Noise Generator, Flyer	5989-7720EN
81150A and 81160A Pulse Function Arbitrary Noise Generator, Application Booklet	5989-7860EN
81150A Quick Fact Sheet	5990-4565EN
81160A Quick Fact Sheet	5990-6984EN
33503A BenchLink Waveform Builder Pro Software, Data Sheet	5990-7569EN

For the latest version of this document, please visit our website at:

www.keysight.com/find/81150

www.keysight.com/find/81160

and go to the Product Library.

Evolving

Our unique combination of hardware, software, support, and people can help you reach your next breakthrough. **We are unlocking the future of technology.**

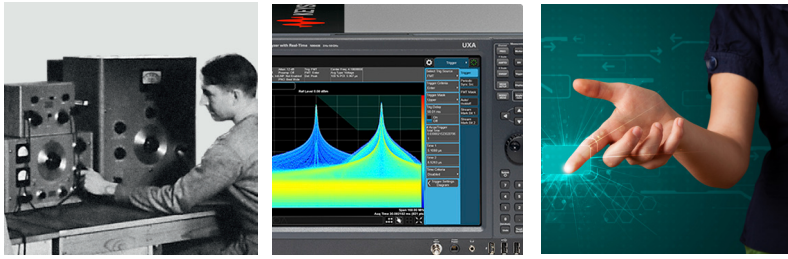

From Hewlett-Packard to Agilent to Keysight

myKeysight

myKeysight
www.keysight.com/find/mykeysight
 A personalized view into the information most relevant to you.



www.axistandard.org
 AdvancedTCA® Extensions for Instrumentation and Test (AXIe) is an open standard that extends the AdvancedTCA for general purpose and semiconductor test. Keysight is a founding member of the AXIe consortium. ATCA®, AdvancedTCA®, and the ATCA logo are registered US trademarks of the PCI Industrial Computer Manufacturers Group.



www.pxisa.org
 PCI eXtensions for Instrumentation (PXI) modular instrumentation delivers a rugged, PC-based high-performance measurement and automation system.



www.lxistandard.org
 LAN eXtensions for Instruments puts the power of Ethernet and the Web inside your test systems. Keysight is a founding member of the LXI consortium.

KEYSIGHT SERVICES

Keysight Services
www.keysight.com/find/service
 Our deep offering in design, test, and measurement services deploys an industry-leading array of people, processes, and tools. The result? We help you implement new technologies and engineer improved processes that lower costs.



Three-Year Warranty
www.keysight.com/find/ThreeYearWarranty
 Keysight's committed to superior product quality and lower total cost of ownership. Keysight is the only test and measurement company with three-year warranty standard on all instruments, worldwide. And, we provide a one-year warranty on many accessories, calibration devices, systems and custom products.

www.keysight.com/find/81150
www.keysight.com/find/81160

For more information on Keysight Technologies' products, applications or services, please contact your local Keysight office. The complete list is available at: www.keysight.com/find/contactus

Americas

Canada	(877) 894 4414
Brazil	55 11 3351 7010
Mexico	001 800 254 2440
United States	(800) 829 4444

Asia Pacific

Australia	1 800 629 485
China	800 810 0189
Hong Kong	800 938 693
India	1 800 11 2626
Japan	0120 (421) 345
Korea	080 769 0800
Malaysia	1 800 888 848
Singapore	1 800 375 8100
Taiwan	0800 047 866
Other AP Countries	(65) 6375 8100

Europe & Middle East

Austria	0800 001122
Belgium	0800 58580
Finland	0800 523252
France	0805 980333
Germany	0800 6270999
Ireland	1800 832700
Israel	1 809 343051
Italy	800 599100
Luxembourg	+32 800 58580
Netherlands	0800 0233200
Russia	8800 5009286
Spain	800 000154
Sweden	0200 882255
Switzerland	0800 805353
	Opt. 1 (DE)
	Opt. 2 (FR)
	Opt. 3 (IT)
United Kingdom	0800 0260637

For other unlisted countries:
www.keysight.com/find/contactus
 (BP-06-08-16)



www.keysight.com/go/quality
 Keysight Technologies, Inc.
 DEKRA Certified ISO 9001:2015
 Quality Management System