

# Star Magnetics™ Gigabit Transformer Modules with PoE\* Option

\*Power over Ethernet

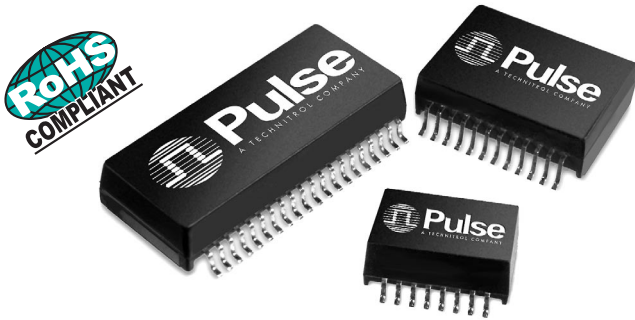

- RoHS reflow temperature rating 245° C
- Meets IEEE 802.3 specification
- Compact footprint

## Electrical Specifications @ 25°C — Operating Temperature 0°C to 70°C

RoHS Compliant Part Number	PoE	Turns Ratio		Number of Ports	Insertion Loss (dB MAX)			Return Loss (Zout = 100 Ω ±15%)				Crosstalk (adjacent channels dB MIN)			Hipot (Vrms MIN)
		Tx	Rx		0.1 MHz	100 MHz	125 MHz	30 MHz	60 MHz	80 MHz	100 MHz	30 MHz	60 MHz	100 MHz	
H5062NL <sup>2a</sup>	No	1:1	1:1	1	-1.1	-1.0	-2.0	-18	-12	-12	-10	-43	-37	-33	1500
H6062NL <sup>2a</sup>	Yes	1:1	1:1	1	-1.1	-1.0	-2.0	-18	-12	-12	-10	-43	-37	-33	1500
H6080NL <sup>2a</sup>	Yes	1:1	1:1	2	-1.1	-1.0	-2.0	-18	-12	-12	-10	-43	-37	-33	1500

- For Tape & Reel packaging add a "T" suffix to the end of the part number when ordering, e.g. H5062NLT
- MSL = Moisture Sensitivity Level a=1 b=2 c=3 d=4 e=5

## Mechanicals

### H5062NL

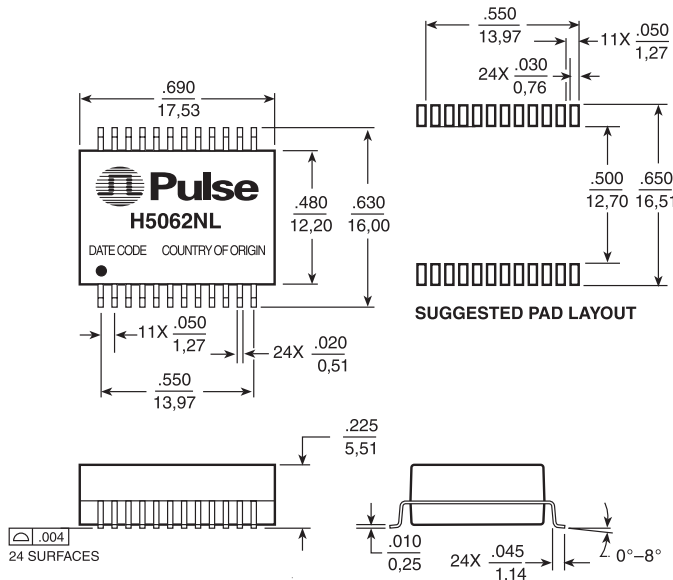

Weight . . . . . 2.7 grams  
 Tape & Reel . . . . . 300/reel  
 Tube . . . . . 25/tube

### H6062NL

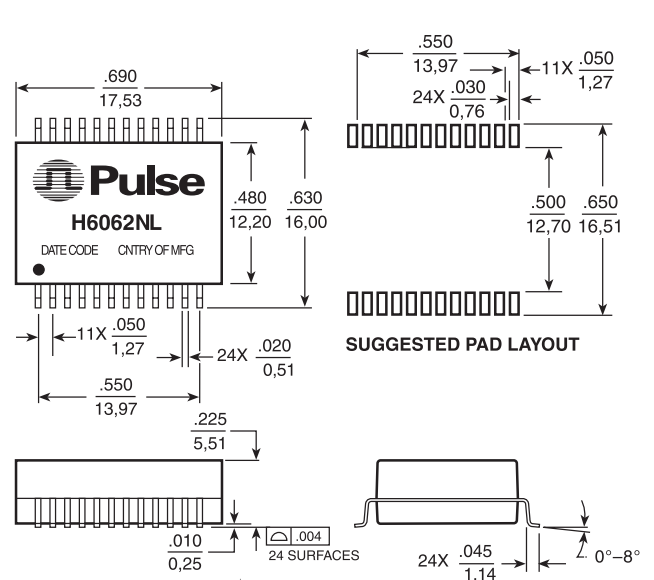

Weight . . . . . 2.63 grams  
 Tape & Reel . . . . . 300/reel  
 Tube . . . . . 25

Dimensions:  $\frac{\text{Inches}}{\text{mm}}$  Unless otherwise specified, all tolerances are  $\pm \frac{.010}{0.25}$

# Star Magnetics™ Gigabit Transformer Modules with PoE\* Option

\*Power over Ethernet



## Mechanicals (continued)

### H6080NL

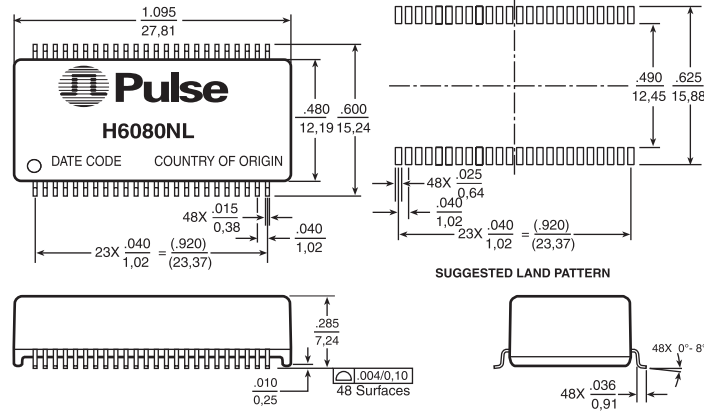

Dimensions:  $\frac{\text{Inches}}{\text{mm}}$  Unless otherwise specified, all tolerances are  $\pm \frac{.010}{0,25}$

Weight ..... 4.0 grams  
Tape & Reel ..... 250/reel  
Tube ..... 15/tube

## Schematics

### H5062NL

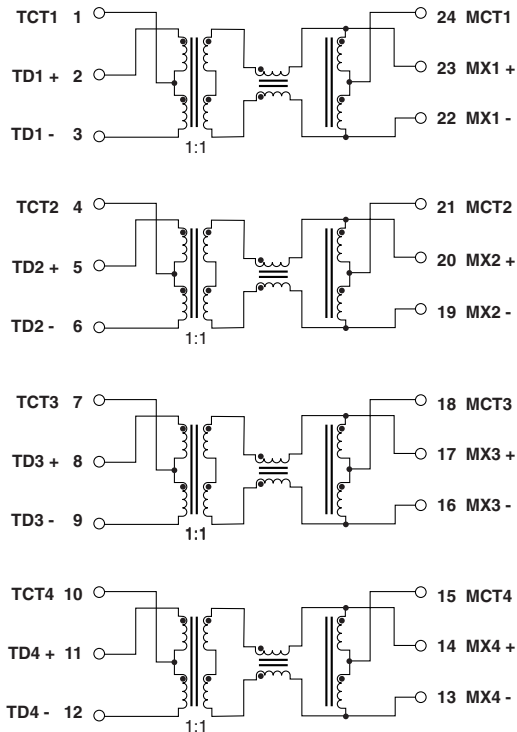

### H6062NL

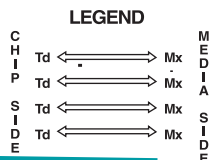
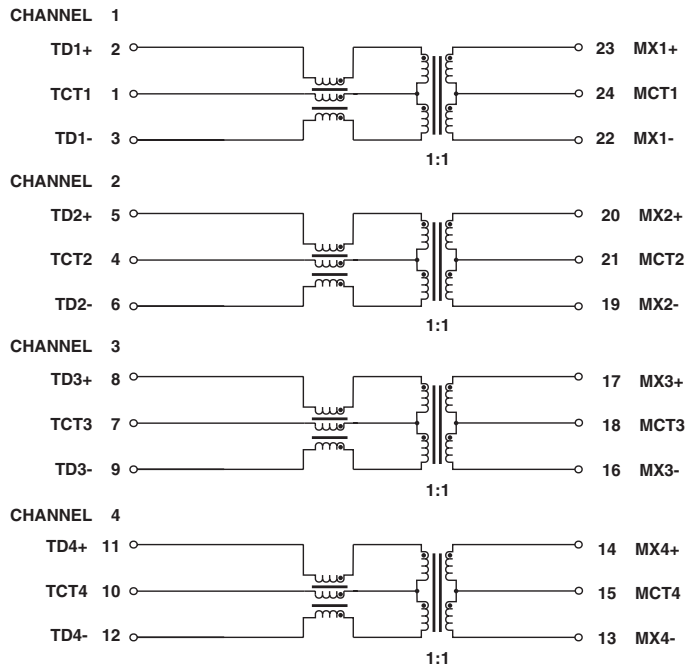

# Star Magnetics™ Gigabit Transformer Modules with PoE\* Option

\*Power over Ethernet



## Schematics (continued)

### H6080NL

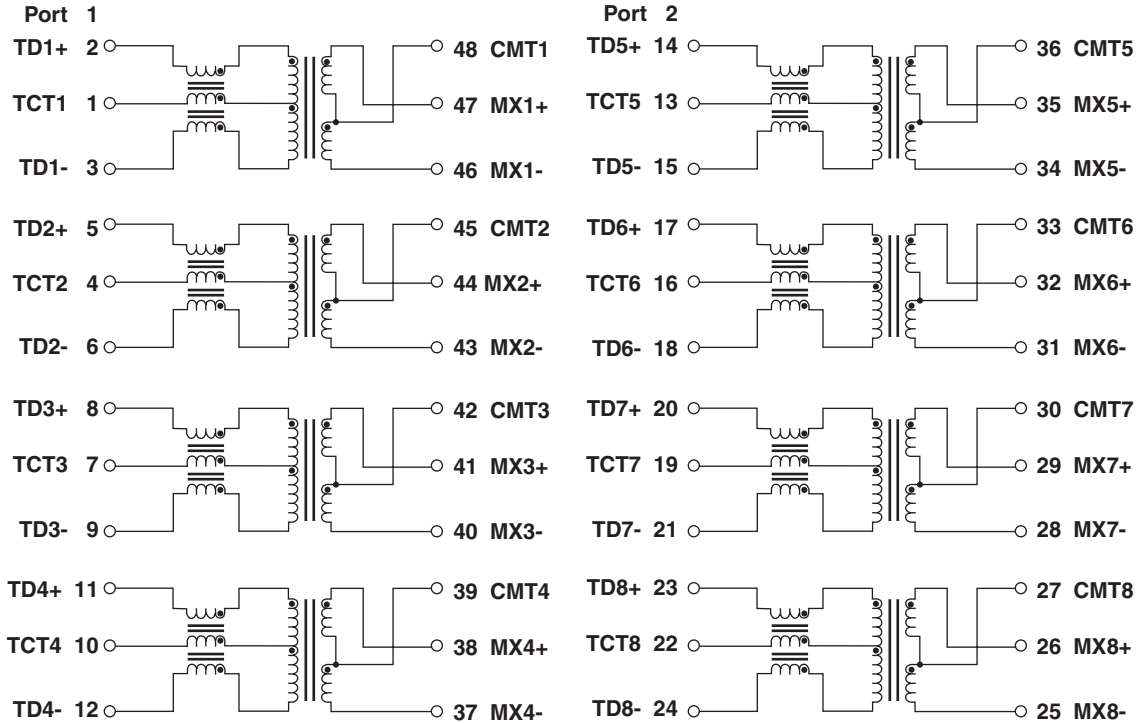

### For More Information:

**Pulse Worldwide Headquarters**  
12220 World Trade Dr.  
San Diego, CA 92128  
U.S.A.

**Pulse Europe**  
Zeppelinstrasse 15  
D-71083 Herrenberg  
Germany

**Pulse China Headquarters**  
B402, Shenzhen Academy of  
Aerospace Technology Bldg.  
10th Kejian Rd.  
High-Tech Zone  
Nanshan District  
Shenzhen, PR China 518057

**Pulse North China**  
Room 2704/2705  
Super Ocean Finance Ctr.  
2067 Yan An Rd. West  
Shanghai 200336  
China

**Pulse South Asia**  
135 Joo Seng Rd.  
#03-02  
PM Industrial Bldg.  
Singapore 368363

**Pulse North Asia**  
3F, No. 198  
Zhongyuan Rd.  
Zhongli City  
Taoyuan County 320  
Taiwan R. O. C.

Tel: 858 674 8100  
Fax: 858 674 8262

Tel: 49 7032 7806 0  
Fax: 49 7032 7806 135

Tel: 86 755 33966678  
Fax: 86 755 33966700

Tel: 86 21 62787060  
Fax: 86 2162786973

Tel: 65 6287 8998  
Fax: 65 6287 8998

Tel: 886 3 4356768  
Fax: 886 3 4356823 (Pulse)  
Fax: 886 3 4356820 (FRE)

Performance warranty of products offered on this data sheet is limited to the parameters specified. Data is subject to change without notice. Other brand and product names mentioned herein may be trademarks or registered trademarks of their respective owners. © Copyright, 2011. Pulse Engineering, Inc. All rights reserved.

# Mouser Electronics

Authorized Distributor

Click to View Pricing, Inventory, Delivery & Lifecycle Information:

Pulse:

[H6062NLT](#) [H5062NL](#) [H6062NL](#) [H5062NLT](#) [H6080NLT](#)