

**harbus® HM** Standard, 2.00 mm pitch

Page

<b>harbus® HM</b> Standard – general information .....	<b>00.04</b>
<b>Types with 5 + 2 rows</b>	
Straight male connectors .....	<b>00.12</b>
Angled female connectors .....	<b>00.24</b>
<b>Monoblock 47</b>	
Straight male connectors .....	<b>00.28</b>
Angled female connectors .....	<b>00.30</b>
<b>Types with 8 + 2 rows</b>	
Straight male connectors .....	<b>00.32</b>
<b>Accessories</b>	
Coding keys .....	<b>00.35</b>
Shrouds .....	<b>00.36</b>
Guiding system .....	<b>00.41</b>
Special connectors for VME64x .....	<b>00.42</b>

Design according	: IEC 61 076 - 4 - 101
Approvals	
Underwriters Laboratories Inc. <sup>®</sup>	:  us with their respective ratings documented in file E 102079
Number of contacts	: 55 – 220 signal (77 – 308 fully shielded); or customised
Contact spacing	: 2.00 mm
Working current	: 1 A @ 70 °C (80 % derating)
Test voltage $U_{r.m.s.}$	: AC 750 V min.
Contact resistance	: 20 mΩ max.
Insulation resistance	: 10 GΩ min.
Temperature range	: – 55 °C ... + 125 °C
Durability as per IEC 61076-4-101	: Performance level 2 = 250 mating cycles in total. <i>First 125 mating cycles, then 4 days gas test using 0.5 ppm SO<sub>2</sub> and 0.1 ppm H<sub>2</sub>S (at 25 ± 2 °C and 75 ± 3 % humidity). Measurement of contact resistance.</i> The <i>remaining 125 mating cycles</i> are subject to measurement of contact resistance and visual inspection. No abrasion of the contact finish through to the base material. No functional impairment. Performance level 1 = 500 mating cycles in total. <i>First 250 mating cycles, then 10 days gas test using 0.5 ppm SO<sub>2</sub> and 0.1 ppm H<sub>2</sub>S (at 25 ± 2 °C and 75 ± 3 % humidity). Measurement of contact resistance.</i> The <i>remaining 250 mating cycles</i> are subject to measurement of contact resistance and visual inspection. No abrasion of the contact finish through to the base material. No functional impairment.
Termination technique	: <b>compliant press-in</b>
Mating force	: 0.75 N/pin max.
Withdrawal force	: 0.15 N/pin min.
Materials	
Mouldings	: Thermoplastic resin, glass-fibre filled, UL 94-V0
Contacts	: Copper alloy
Contact surface	
Contact zone male	: Au/PdNi/Ni, contacts are treated with Bellcore recommended lubricant (PPE)
Contact zone female	: Au/Ni, contacts are treated with Bellcore recommended lubricant (PPE)
Press-in zone	: Ni
Packaging	: Tube

Due to the high deformation capability and resilience of **harbus<sup>®</sup> HM** press-in contacts, they can be easily and repeatedly removed in case of repairs without impairment to their functioning.

**harbus<sup>®</sup> HM** press-in contacts are extremely versatile and offer a reliable electrical contact, therefore they are especially well suited for applications with these surfaces.

Please contact us for detailed test reports.

**Benefits of press-in technology**

- Thermal shocks associated with the soldering process and the risk of the board malfunction are avoided.
- No need for the subsequent cleaning of the assembled pcb's
- Unlimited and efficient processing of partially gold-plated pins for rear I/O - manual soldering is no longer necessary!

**Recommended configuration of plated through holes**

In addition to the hot-air-level (HAL), other pcb surfaces are getting more important. Due to their different properties, such as mechanical strength and coefficient of friction we recommend the following configuration of pcb through holes.

<i>Tin plated PCB (HAL) acc. EN 60352-5</i>	Hole-Ø	0.7±0.02 mm
	Cu	min. 25 µm
	Sn	max. 15 µm
	Plated hole-Ø	0.60-0.65 mm
<i>Chemical tin plated PCB</i>	Hole-Ø	0.7±0.02 mm
	Cu	min. 25 µm
	Sn	min. 0.8 µm
	Plated hole-Ø	0.60-0.65 mm
<i>Au / Ni plated PCB</i>	Hole-Ø	0.7±0.02 mm
	Cu	min. 25 µm
	Ni	3-7 µm
	Au	0.05-0.12 µm
	Plated hole-Ø	0.60-0.65 mm
<i>Silver plated PCB</i>	Hole-Ø	0.7±0.02 mm
	Cu	min. 25 µm
	Ag	0.1-0.3 µm
	Plated hole-Ø	0.60-0.65 mm
<i>OSP copper plated PCB</i>	Hole-Ø	0.7±0.02 mm
	Cu	min. 25 µm
	Plated hole-Ø	0.60-0.65 mm

PCB board thickness: ≥ 1.4 mm

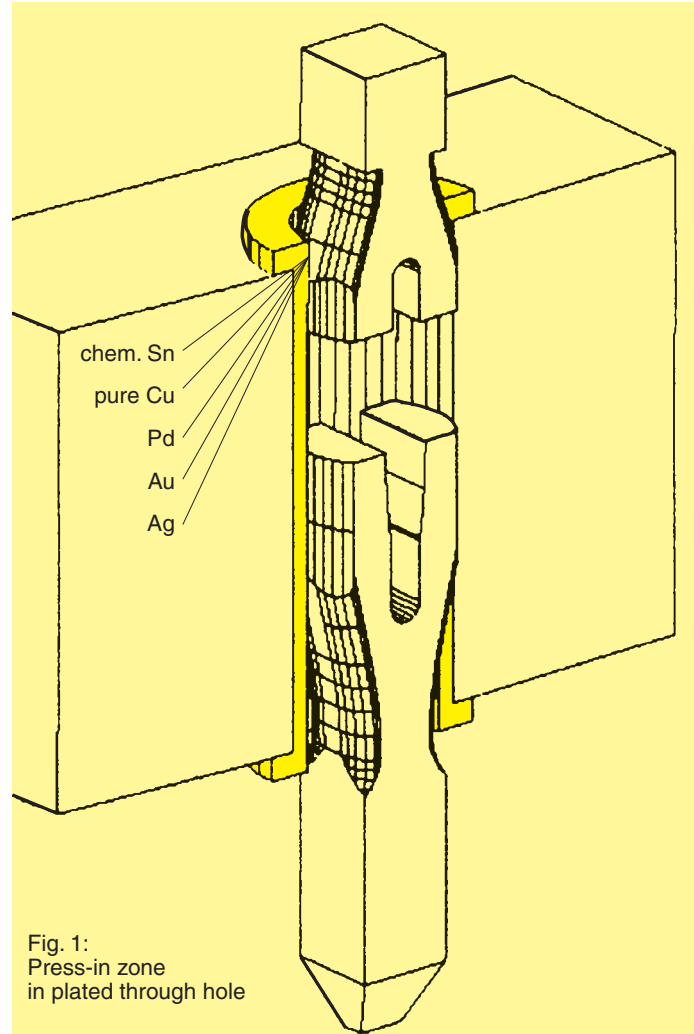

Fig. 1: Press-in zone in plated through hole

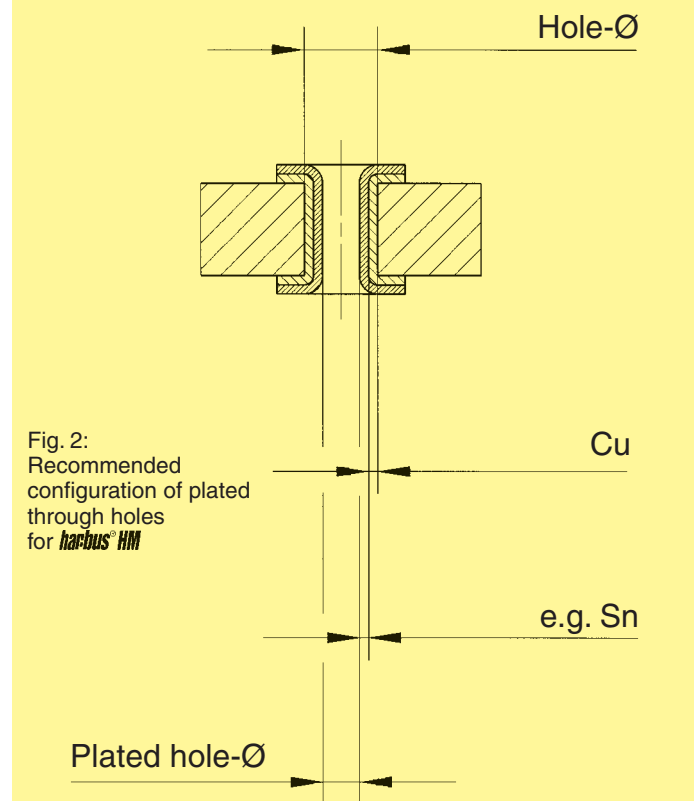

Fig. 2: Recommended configuration of plated through holes for **harbus<sup>®</sup> HM**

HARTING offers 13 contact lengths for *harbus<sup>®</sup> HM* male connectors: the standard mating length of 8.2 mm, pre-leading contacts with 9.7 mm and extra long contacts preferred for shielding with 11.2 mm mating length.

On the termination side the standard length is 3.7 mm. With the three termination lengths of 13.0, 14.5 and 16.0 mm even for rear I/O applications different mating levels are possible, depending on the pcb thickness and shroud height.

For the standard termination length, an extra short contact for special applications with a mating length of 7.2 mm is available.

The different contact lengths are designated with letters to identify them in the configurations. For special loadings please use the customer request form at the end of this catalogue.

All contacts are offered with press-in termination 'eye of the needle'. In accordance with the application they can be delivered in performance level 1 or 2.

Contact dimensions [mm]

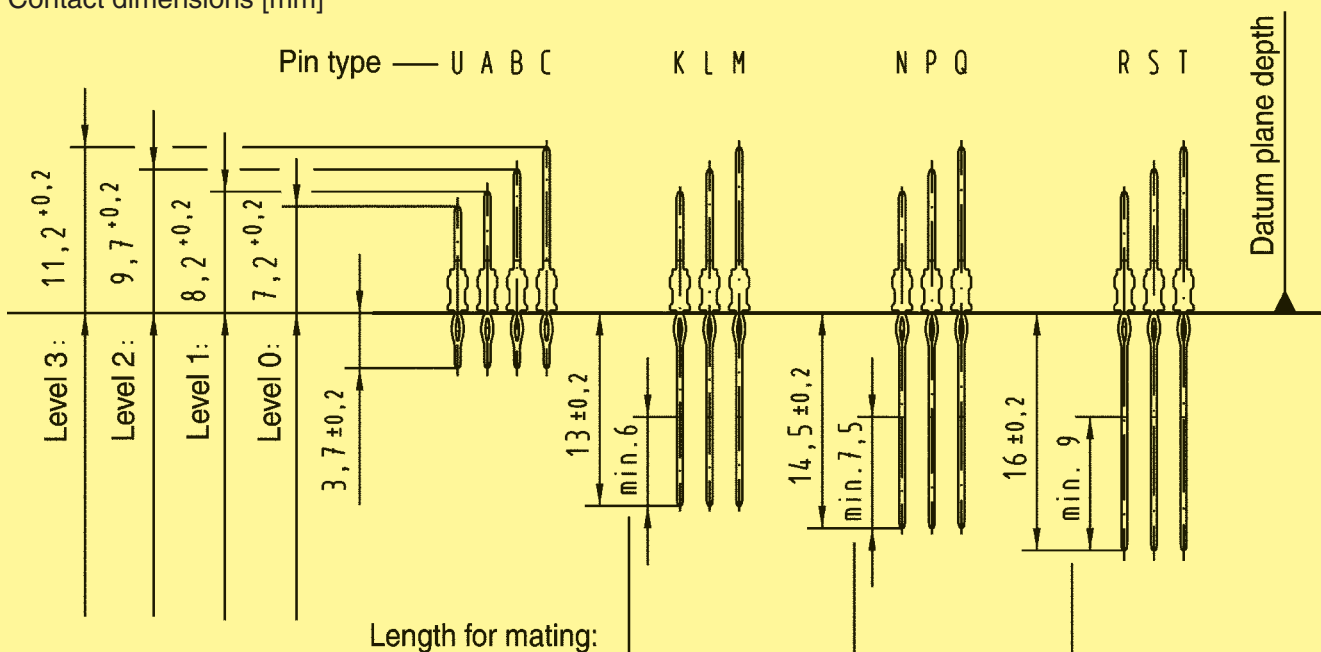

Circuit density

When using the specified diameter of the finished through hole according to IEC 61076-4-101 (0.6 ± 0.05 mm) with an appropriate annular ring, the remaining distance between the rings is about 1 mm. Under the condition that the width of the track and the space between should be equal, two tracks of 0.2 mm width or three tracks of 0.14 mm width can be placed between two rings. Typical designs are shown in the drawing on the right side.

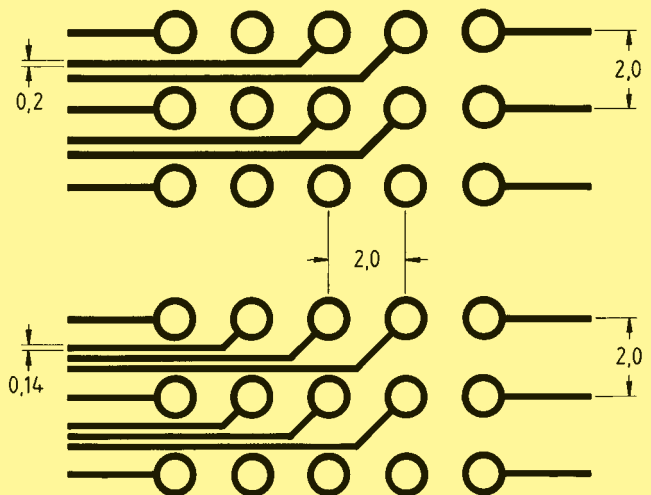

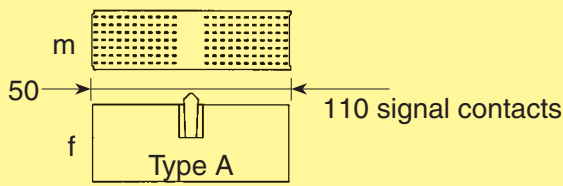

All HARTING *harbus<sup>®</sup> HM* connectors can be assembled end to end in any configuration.

General rules:

- Type B connectors should always be used in combination with an A type and/or C type connectors that are fitted with alignment features.
- Type C connectors must be assembled at the end of a connector stack, to achieve polarisation and avoid mismatching.
- To ensure the correct slot position of connector stacks coding can be added with type A connectors.
- Starting with an A type module (50 mm) any module can be added within the above recommendation (see typical examples shown in the diagram).

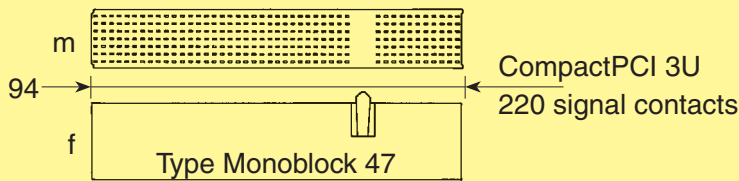
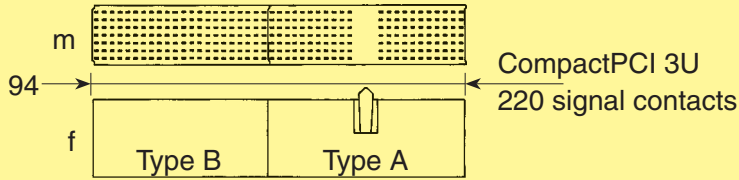

m = male connector  
f = female connector

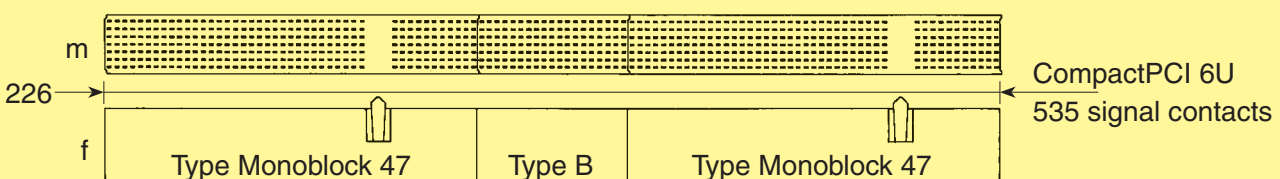
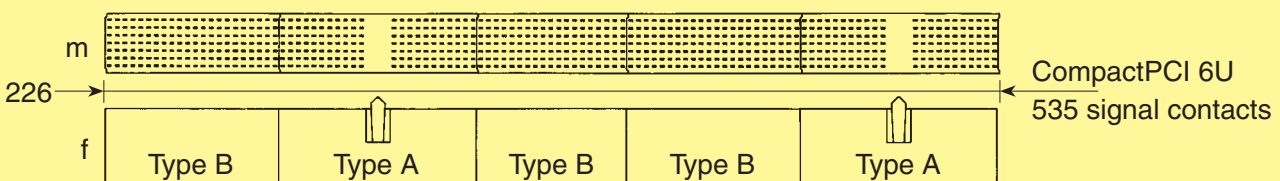
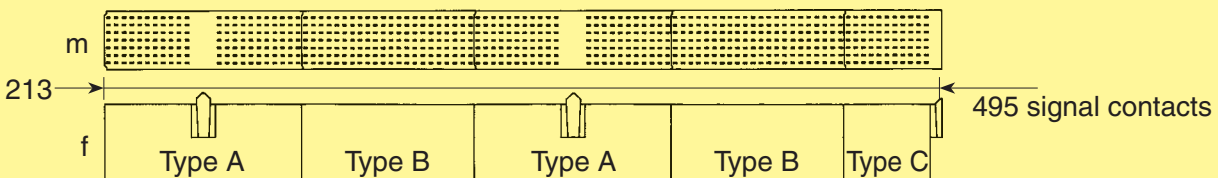
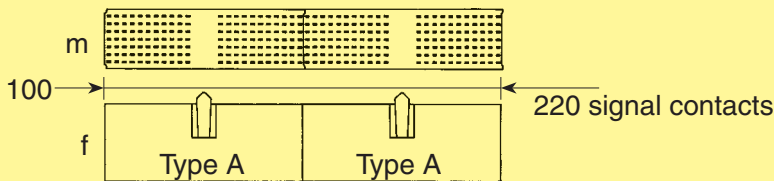

**Improved guiding with AB-modules:**

In accordance with the equipment practice each front side arrangement of *harbus<sup>®</sup> HM* connectors shall have at least one A-module per slot to ensure that the connector can accommodate  $\pm 2$  mm alignment tolerances in rack systems.

On some rear I/O arrangements the A-module's alignment capability cannot be utilised, because only B-modules are used for feed through. Consequently AB-modules were introduced to ensure guiding capabilities where formerly only B-modules were used. Those AB-modules represent a combination of A- and B-modules and are specified in **CompactPCI by PICMG 2.0 Rev. 3.0** for certain rear I/O applications.

The AB-modules have guiding pegs similar (but not mating compatible to prevent mismating) to those

of the A-module providing the same proven mating tolerances of  $\pm 2$  mm. The AB-modules have no coding center but are fully equipped with contacts in order to maintain the full density as per the B-modules.

The **AB-female** connector mates either with an **AB-shroud** or with **AB-male** connectors. The centered pin positions of the shielding rows of male connectors are simply equipped with short spill contacts (if standard connector and shroud are used). This prevents that the guiding peg of the female AB-module stubbing on the feed through contacts of the front side's fixed connector. These fixed connector loadings are called **AB-friendly**.

The AB-male connector will not be equipped with shielded contacts in the centre where the guiding peg will engage.

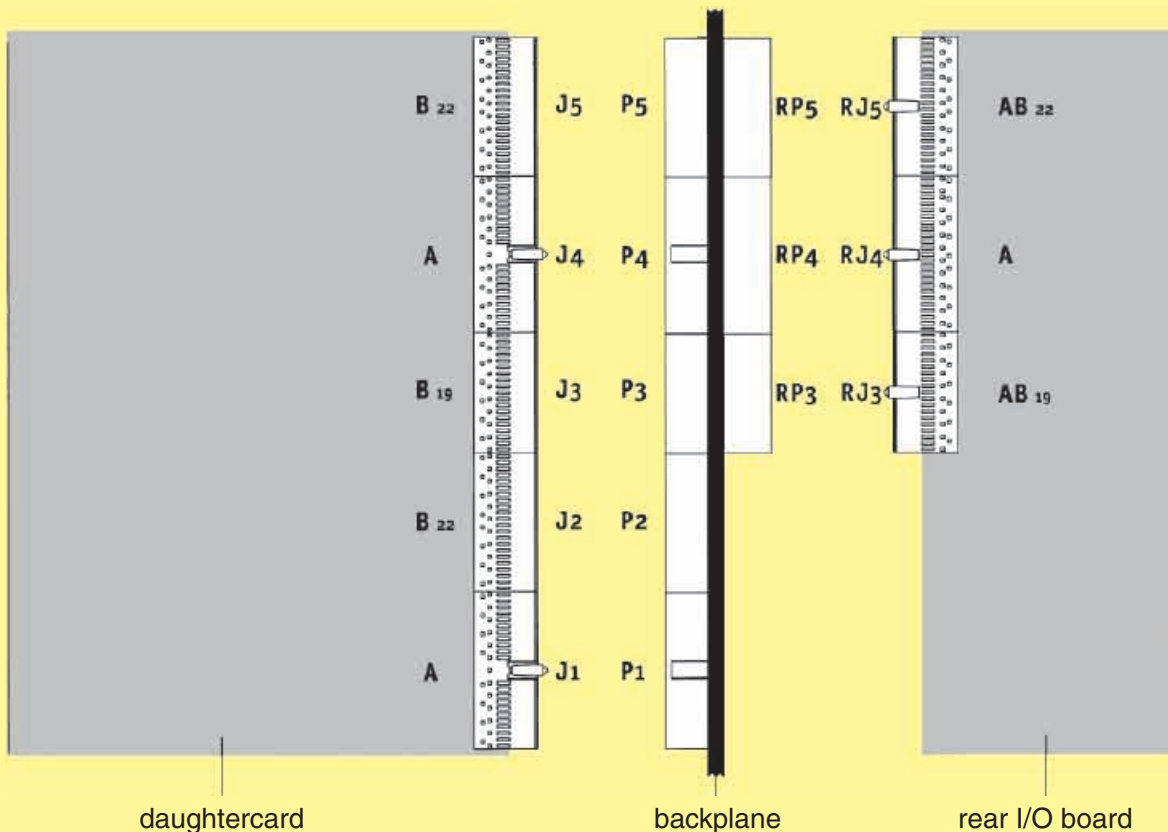
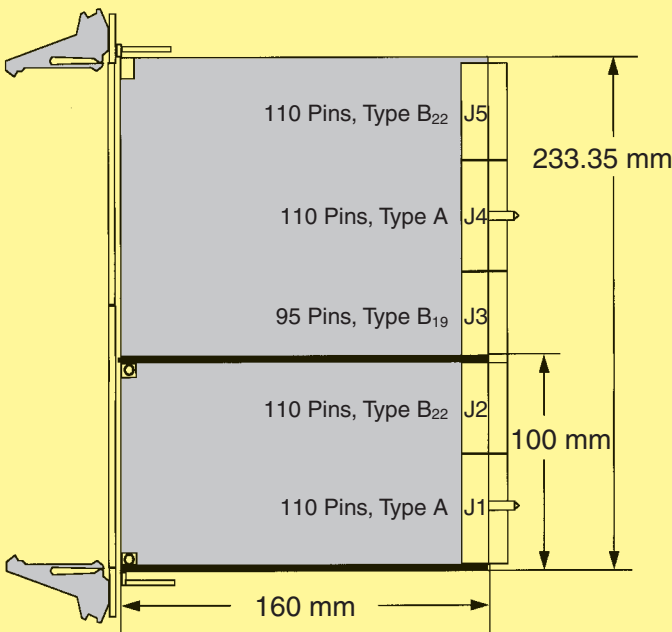
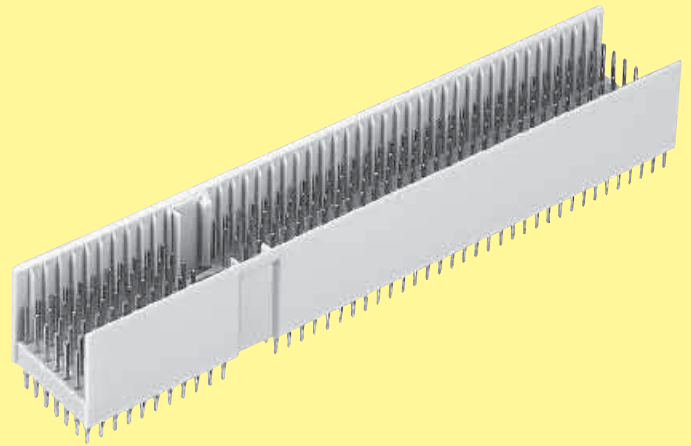

Fig. 3: CompactPCI 6U configuration

CompactPCI<sup>®</sup> as a standard is maintained and enhanced by the PCI Industrial Computer Manufacturers Group (PICMG<sup>®</sup>). It defines a combination of the electrical and logical specifications of the PCI standard and the mechanical specifications of the IEEE 1101 and IEC 60297 series of standards. The board connector has been developed from the IEC 61076-4-101 series of 2.0 mm connectors. The mounting location and dimensions for the 2.0 mm connectors are specified in IEEE 1101.11. Some additional mechanical definitions for 2.0 mm connectors in the Eurocard format are being specified in the VITA 30 draft.

Other international standards are listed in the CompactPCI<sup>®</sup> standard for environmental and related specifications. This gives CompactPCI<sup>®</sup>

the full complement of connectors to be compatible with any type of board.



a solid foundation of international standards and practices for mechanical robustness.

The board format is either a 3U or a 6U Eurocard as defined in IEC 60297. There are two or five connectors specified for 3U or 6U boards respectively. Connectors are numbered from J1/P1 through J5/P5 (bottom to top) on the board or backplane. Slave or peripheral boards need J1/P1 as a minimum, master or system boards need both J1/P1 and J2/P2 as a minimum. Backplanes should always have

As opposed to the CPCI standard (pins numbered from bottom to top), the contact numbers on the connector are numbered from top to bottom (according to the IEC standard).

The front panel of CPCI cards may be equipped with additional keying pegs to code individual board types. There is also an extended pin length to remove any electro static charge before contacts on the rear connectors mate. This pin also functions as a mechanical guide to position the board as straight as possible for insertion. This prevents pin bending and lowers the insertion force. Some applications could require up to 500 pins to be pushed into sockets simultaneously.

Connectors for high availability applications (hot swap) come with 3 different lengths of pins for a staged sequence of mate or break of contact.

Connector J1/P1 carries the signals for a 32 bit PCI bus (see table of contact assignments for J1/P1). Connector J2/P2 on a system card has the additional signals for a 64 bit PCI bus and some user-defined I/O (see table of contact assignments for J2/P2). On slave cards all of J2/P2 might be user-defined I/O except the top row which carries the signals for geographical addressing. J3/P3 should be reserved for other system bus definitions. J4/P4 and J5/P5 are used for I/O or secondary buses, e.g. H.110 in telecom applications or for bridges into other buses like VMEbus. This is used to accommodate two bus platforms in one card cage on one backplane.

Contact assignment on CompactPCI<sup>®</sup> system position (J1/P1)

	a	b	c	d	e	
25	+5 V	REQ64#	ENUM#	+3,3 V	+5 V	25
24	AD[1]	+5 V	V(I/O)	AD[0]	ACK64#	24
23	+3,3 V	AD[4]	AD[3]	+5 V	AD[2]	23
22	AD[7]	GND	+3,3 V	AD[6]	AD[5]	22
21	+3,3 V	AD[9]	AD[8]	M66EN	C/BE[0]#	21
20	AD[12]	GND	V(I/O)	AD[11]	AD[10]	20
19	+3,3 V	AD[15]	AD[14]	GND	AD[13]	19
18	SERR#	GND	+3,3 V	PAR	C/BE[1]#	18
17	+3,3 V	SDONE	SBO#	GND	PERR#	17
16	DEVSEL#	GND	V(I/O)	STOP#	LOCK#	16
15	+3,3 V	FRAME#	IRDY#	GND	TRDY#	15
14						14
13	Key Area					13
12						12
11	AD[18]	AD[17]	AD[16]	GND	C/BE[2]#	11
10	AD[21]	GND	+3,3 V	AD[20]	AD[19]	10
9	C/BE[3]#	IDSEL	AD[23]	GND	AD[22]	9
8	AD[26]	GND	V(I/O)	AD[25]	AD[24]	8
7	AD[30]	AD[29]	AD[28]	GND	AD[27]	7
6	REQ#	GND	+3,3 V	CLK	AD[31]	6
5	Bus Reserved	Bus Reserved	RST#	GND	GNT#	5
4	Bus Reserved	GND	V(I/O)	INTP	INTS	4
3	INTA#	INTB#	INTC#	+5 V	INTD#	3
2	TCK	+5 V	TMS	TDO	TDI	2
1	+5 V	-12 V	TRST#	+12 V	+5 V	1
	a	b	c	d	e	

Contact assignment on CompactPCI<sup>®</sup> system position (J2/P2)

	a	b	c	d	e	
22	GA4	GA3	GA2	GA1	GA0	22
21	CLK6	GND	Reserved	Reserved	Reserved	21
20	CLK5	GND	Reserved	GND	Reserved	20
19	GND	GND	Reserved	Reserved	Reserved	19
18	Bus Reserved	Bus Reserved	Bus Reserved	GND	Bus Reserved	18
17	Bus Reserved	GND	PRST#	REQ6#	GNT6#	17
16	Bus Reserved	Bus Reserved	DEG#	GND	Bus Reserved	16
15	Bus Reserved	GND	FAL#	REQ5#	GNT5#	15
14	AD[35]	AD[34]	AD[33]	GND	AD[32]	14
13	AD[38]	GND	V(I/O)	AD[37]	AD[36]	13
12	AD[42]	AD[41]	AD[40]	GND	AD[39]	12
11	AD[45]	GND	V(I/O)	AD[44]	AD[43]	11
10	AD[49]	AD[48]	AD[47]	GND	AD[46]	10
9	AD[52]	GND	V(I/O)	AD[51]	AD[50]	9
8	AD[56]	AD[55]	AD[54]	GND	AD[53]	8
7	AD[59]	GND	V(I/O)	AD[58]	AD[57]	7
6	AD[63]	AD[62]	AD[61]	GND	AD[60]	6
5	C/BE[5]#	GND	V(I/O)	C/BE[4]#	PAR64	5
4	V(I/O)	Bus Reserved	C/BE[7]#	GND	C/BE[6]#	4
3	CLK4	GND	GNT3#	REQ4#	GNT4#	3
2	CLK2	CLK3	SYSEN#	GNT2#	REQ3#	2
1	CLK1	GND	REQ1#	GNT1#	REQ2#	1
	a	b	c	d	e	

In mechanical terms J1/P1 is a 25x5 matrix of contacts. Three rows of 5 contacts (rows 12 - 14) are not used for electrical contacts. Instead, plastic keys of different orientation and configuration are used to key board locations as to system or peripheral slot, voltage options, etc.

J2/P2 is a shortened connector with only 22 rows of contacts instead of 25 rows for a standard size. HARTING now offers monolithic versions with J1/P1 and J2/P2 combined in one single connector.

This combination together with some space left on the card to fit into guide rails makes maximum use of the 100 mm rear edge of the 3U Eurocard.

On a 6U card this connector setup is repeated on J4/P4 and J5/P5.

The J3/P3 connector is a shortened version of the 2.0 mm connector with 19 rows of 5 signal contacts.

The size results from the height of a 6U board (233 mm) which is more than double the height of a 3U board.

All connectors used for CompactPCI<sup>®</sup> are based on a 7 column pitch. The inner 5 columns are used for logic signals and power. The outer columns on either side are reserved for shielding or ground.



Executive Member



The VMEbus has evolved over a period of more than 25 years to become the leading bus architecture in open industrial applications. The specification is an ANSI norm, the original specification has been extended to become a draft standard VME64x ANSI/VITA 1.1-1997. This draft standard includes the specification for the 5-row DIN compatible connector (IEC 61076-4-113) and for a centre connector J0/P0 on 6U VME cards, which is identical to J3/P3 in *CompactPCI*<sup>®</sup> systems.

In VMEbus systems it is possible to use custom connectors in the J0/P0 area (e.g. coax connectors). To prevent problems with non-mating backplanes it is strongly recommended to use front panel keying. The IEEE 1101 documents J0/P0 can also be used with rear transition modules for pluggable I/O cabling. As mentioned above, the contacts on this connector may be bussed. One example is the ATM CellBus, which is in the process of being standardised. The bus on J0/P0 connectors might actually be a plug-on mezzanine backplane rather than conducting traces integrated into the backplane itself.

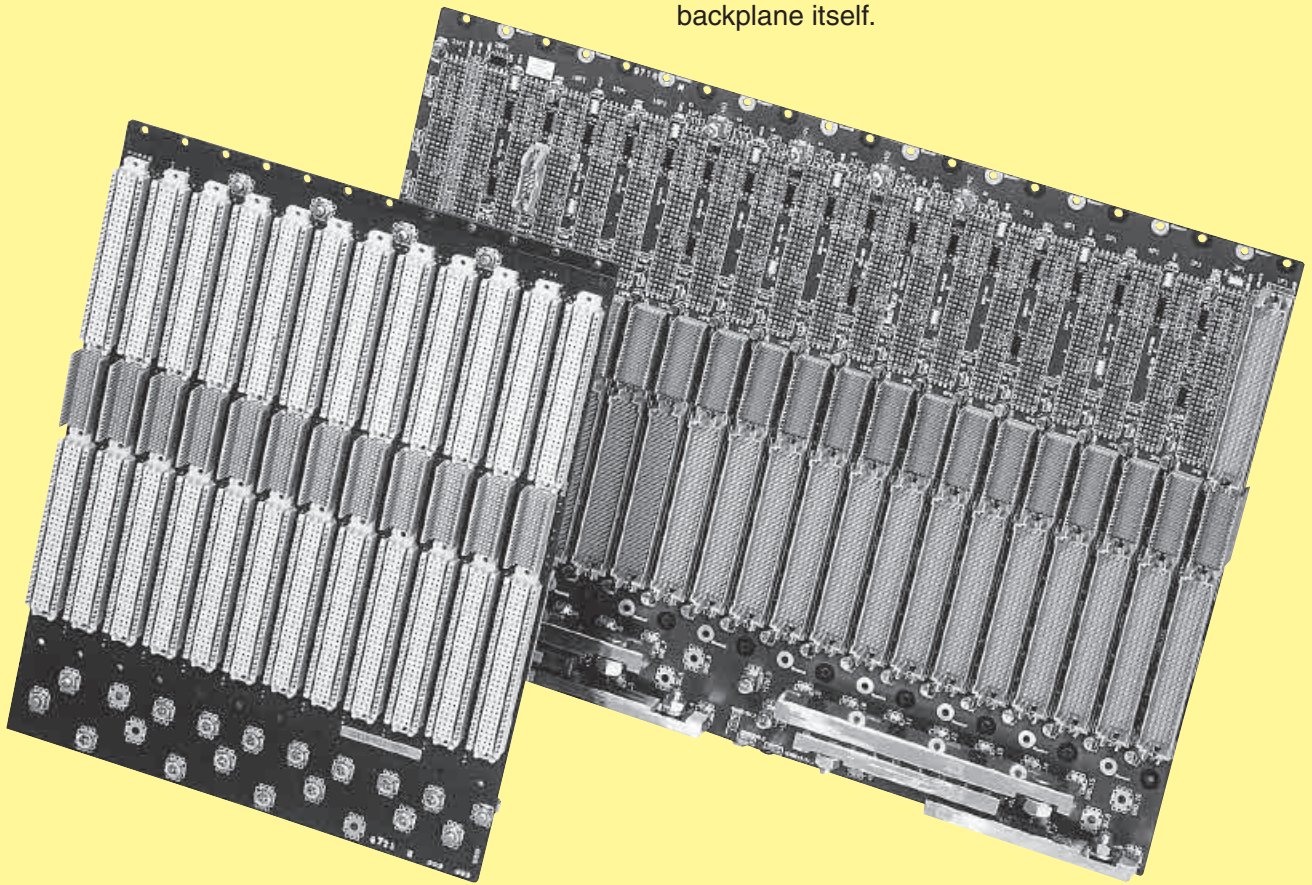

The 2.0 mm J0/P0 connector in VME64x systems is used for additional I/O, for new high speed sub busses or I/O for mezzanine modules, e.g. IP modules on VMEbus boards. The connector is placed on the Eurocard to work in combination with the non-metric original VMEbus connectors DIN 41 612 type C or the newer 5-row connector harbus<sup>®</sup> 64. The mounting location and dimensions for the J0/P0 VMEbus connector (IEC 61076-4-101) is specified in IEEE 1101.11. The VMEbus 2.0 mm connector uses 5 columns of signal contacts and optional two additional outer columns on either side for shielding. All 95 signal contacts are user defined.



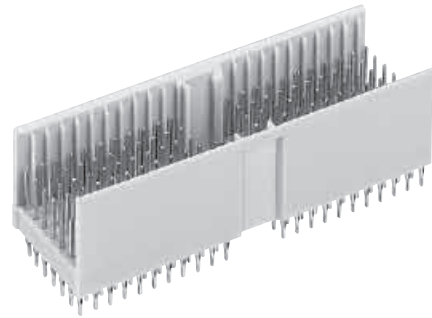

Male connectors, straight

Identification	Number of contacts	Contact length [mm] mating side	termination side	Part number	Contact configuration
Type A	110	8.2	3.7	17 01 110 1201 <b>17 01 110 2201</b>	
Type A	132	8.2/ 11.2	3.7	17 01 132 1203 <b>17 01 132 2203</b>	
Type A	132	8.2/ 11.2	3.7/ 13.0/ 16.0	17 01 132 1007 <b>17 01 132 2007</b>	
Type A	154	8.2/ 11.2	3.7	17 01 154 1201 <b>17 01 154 2201</b>	
Type A	110	9.7	3.7	17 01 110 1204 <b>17 01 110 2204</b>	
Type A	154	9.7/ 11.2	3.7	17 01 154 1205 <b>17 01 154 2205</b>	

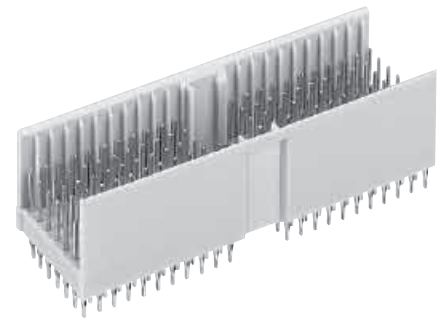

Male connectors, straight

Identification	Number of contacts	Contact length [mm] mating side	termination side	Part number	Contact configuration
Type A	110	8.2	13.0	17 01 110 1402 <b>17 01 110 2402</b>	
Type A	154	9.7/ 11.2	14.5/ 16.0	17 01 154 1001 <b>17 01 154 2001</b>	
Type A CompactPCI Position P1	154	8.2/ 9.7/ 11.2	3.7	17 01 154 1203 <b>17 01 154 2203</b>	
Type A CompactPCI Position P4	154	9.7/ 11.2	16.0	17 01 154 1604 <b>17 01 154 2604</b>	
Type A CompactPCI Position P4	154	8.2/ 9.7/ 11.2	16.0	17 01 154 1603 <b>17 01 154 2603</b>	
Type A CompactPCI hot swap Position P1	154	8.2/ 9.7/ 11.2	3.7	17 01 154 1204 <b>17 01 154 2204</b>	

Thin print part numbers: performance level 1  
**Bold print part numbers: performance level 2**  
 Connector dimensions see page 00.14

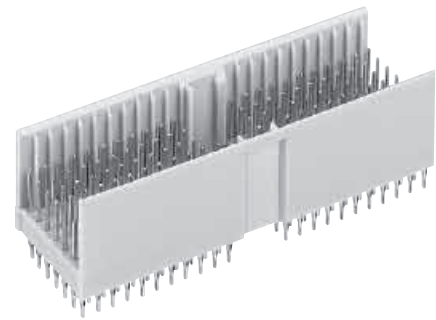

Male connectors, straight

Identification	Number of contacts	Contact length [mm] mating side	termination side	Part number	Contact configuration
Type A CompactPCI computer telephony Position P4	100	/ 8.2/ / 9.7/ 11.2	/13.0/ /14.5/ 16.0	17 01 100 1001 <b>17 01 100 2001</b>	
Type A CompactPCI computer telephony Position P4	100	/ 8.2/ / 9.7/ 11.2	3.7	17 01 100 1201 <b>17 01 100 2201</b>	

Contact dimensions [mm]

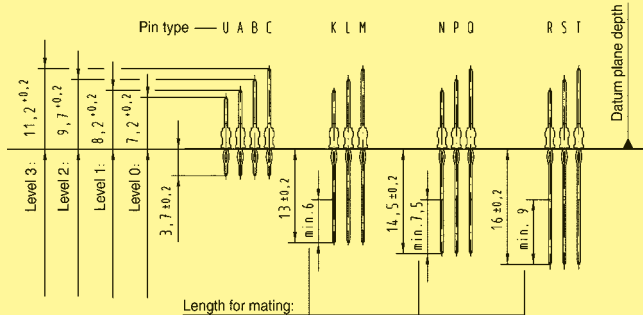

Connector dimensions [mm]

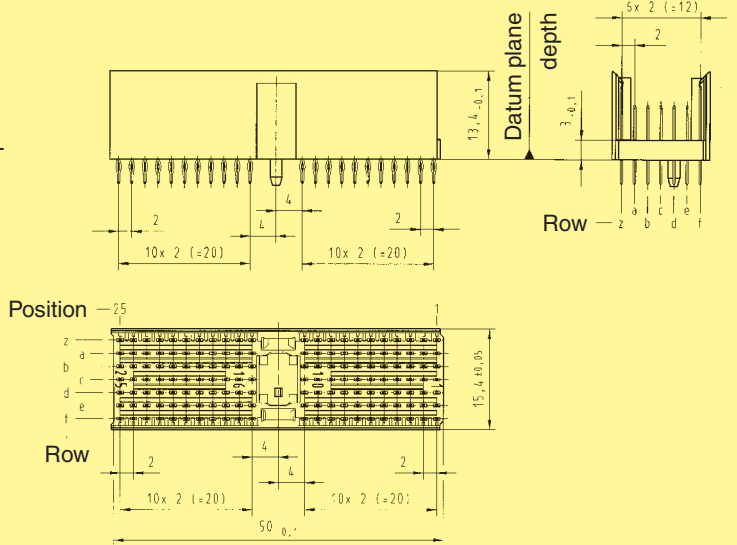

Board drillings

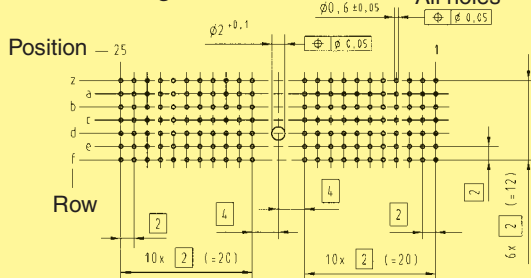

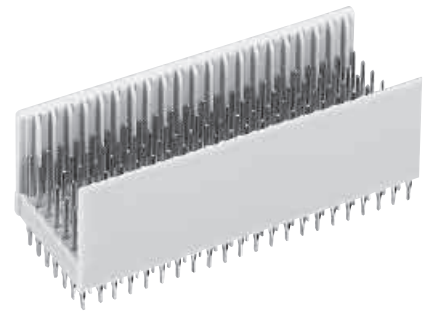

Male connectors, straight

Identification	Number of contacts	Contact length [mm] mating side    termination side		Part number	Contact configuration
Type B25	125	8.2	3.7	17 02 125 1201 <b>17 02 125 2201</b>	
Type B25	150	8.2/ 11.2	3.7	17 02 150 1201 <b>17 02 150 2201</b>	
Type B25	175	8.2/ 11.2	3.7	17 02 175 1201 <b>17 02 175 2201</b>	
Type B25	125	9.7/ 11.2	3.7	17 02 125 1205 <b>17 02 125 2205</b>	
Type B25	175	8.2/ 9.7/ 11.2	3.7	17 02 175 1202 <b>17 02 175 2202</b>	
Type B25	175	8.2/ 11.2	13.0/ 16.0	17 02 175 1006 <b>17 02 175 2006</b>	

Thin print part numbers: performance level 1  
**Bold print part numbers: performance level 2**  
 Connector dimensions see page 00.18

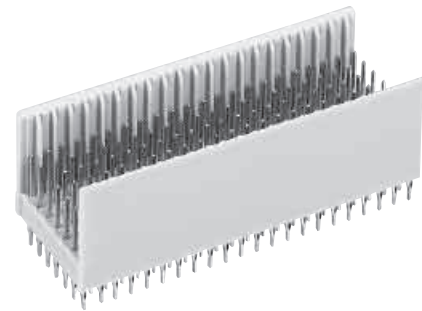

Male connectors, straight

Identification	Number of contacts	Contact length [mm] mating side	termination side	Part number	Contact configuration
Type B22	110	8.2	3.7	17 04 110 1201 <b>17 04 110 2201</b>	
Type B22	154	8.2/ 11.2	3.7	17 04 154 1201 <b>17 04 154 2201</b>	
Type B22 CompactPCI Position P2	154	9.7/ 11.2	3.7	17 04 154 1203 <b>17 04 154 2203</b>	
Type B22 CompactPCI computer telephony	132	8.2/ 9.7/ 11.2	13.0/ 14.5/ 16.0	17 04 132 1001 <b>17 04 132 2001</b>	
Type B22 CompactPCI AB friendly	154	9.7/ 11.2	3.7/ 16.0	17 04 154 1010 <b>17 04 154 2010</b>	
Type B22 CompactPCI AB friendly	154	9.7/ 11.2	3.7/ 14.5/ 16.0	17 04 154 1002 <b>17 04 154 2002</b>	

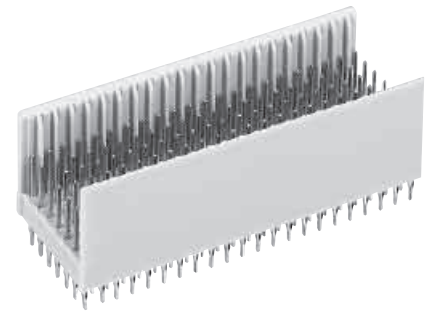

Male connectors, straight

Identification	Number of contacts	Contact length [mm] mating side	termination side	Part number	Contact configuration
Type B19 VME Position J0	95	8.2	3.7	17 05 095 1201 <b>17 05 095 2201</b>	
Type B19 VME Position J0	133	8.2/ 11.2	3.7	17 05 133 1201 <b>17 05 133 2201</b>	
Type B19 VME Position J0	133	9.7/ 11.2	3.7	17 05 133 1203 <b>17 05 133 2203</b>	
Type B19 VME Position J0	95	8.2	13.0	17 05 095 1401 <b>17 05 095 2401</b>	
Type B19 CompactPCI AB friendly Position P3	133	9.7/ 11.2	3.7/ 16.0	17 05 133 1005 <b>17 05 133 2005</b>	
Type B19 Compact PCI Position P3 VME Position J0	133	8.2/ 11.2	16.0	17 05 133 1602 <b>17 05 133 2602</b>	

Thin print part numbers: performance level 1  
**Bold print part numbers: performance level 2**  
 Connector dimensions see page 00.18

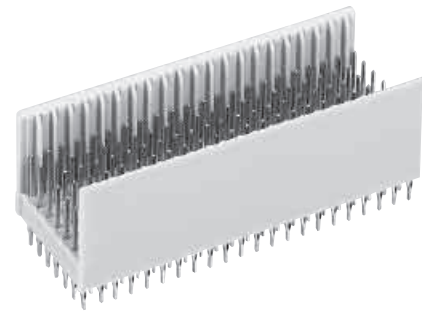

Male connectors, straight

Drawing

Dimensions in mm

Contact dimensions [mm]

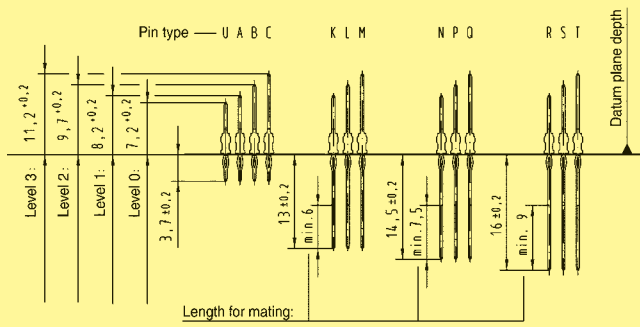

Connector dimensions [mm]

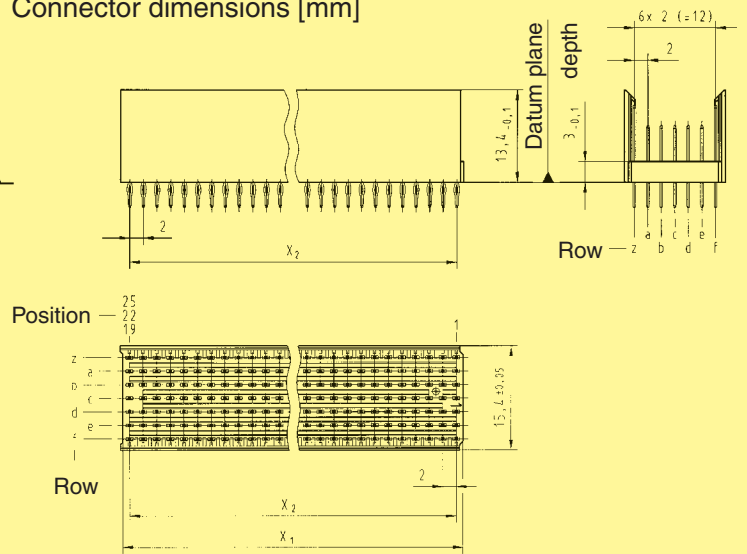

Board drillings

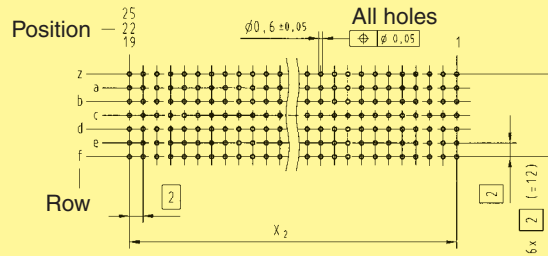

Contact positions	x <sub>1</sub>	x <sub>2</sub>
19	37.9	18 x 2 (= 36)
22	43.9	21 x 2 (= 42)
25	49.9	24 x 2 (= 48)





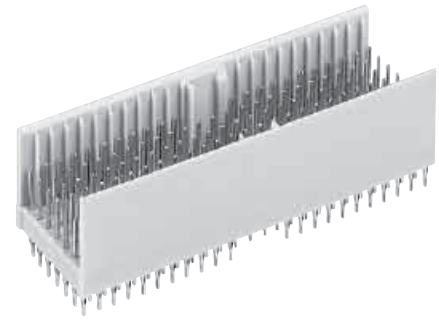

Male connectors, straight

Identification	Number of contacts	Contact length [mm] mating side	termination side	Part number	Contact configuration
Type AB <sub>22</sub>	110	8.2	3.7	17 14 110 1201 <b>17 14 110 2201</b>	
Type AB <sub>22</sub>	146	8.2/ 11.2	3.7	17 14 146 1201 <b>17 14 146 2201</b>	
Type AB <sub>22</sub>	146	9.7/ 11.2	16.0	17 14 146 1601 <b>17 14 146 2601</b>	

Contact dimensions [mm]

Connector dimensions [mm]

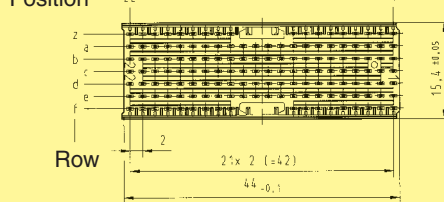
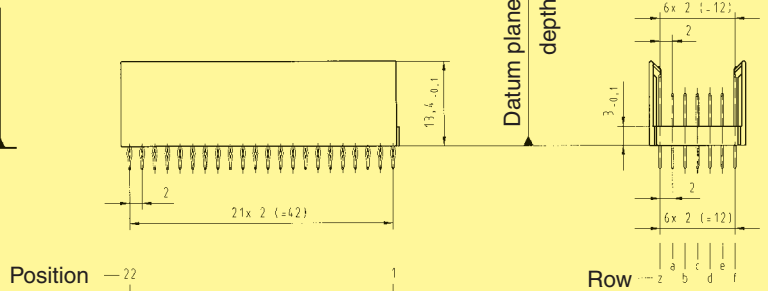
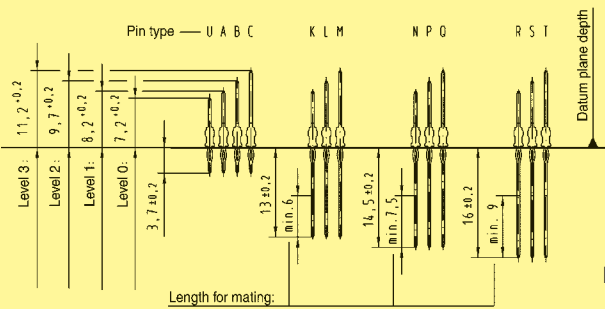

Board drillings

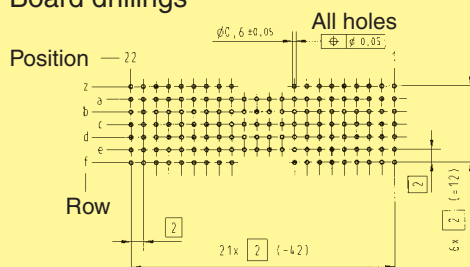

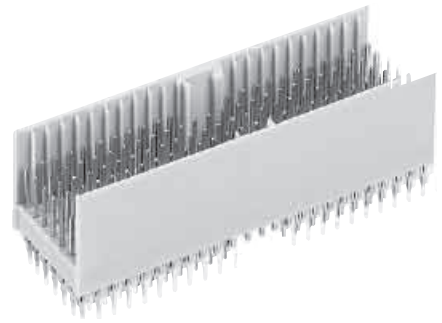

Male connectors, straight

Identification	Number of contacts	Contact length [mm] mating side	termination side	Part number	Contact configuration
Type AB <sub>19</sub>	95	8.2	3.7	17 13 095 1201 17 13 095 2201	
Type AB <sub>19</sub>	127	8.2/ 11.2	3.7	17 13 127 1201 17 13 127 2201	
Type AB <sub>19</sub>	127	9.7/ 11.2	16.0	17 13 127 1601 17 13 127 2601	

Contact dimensions [mm]

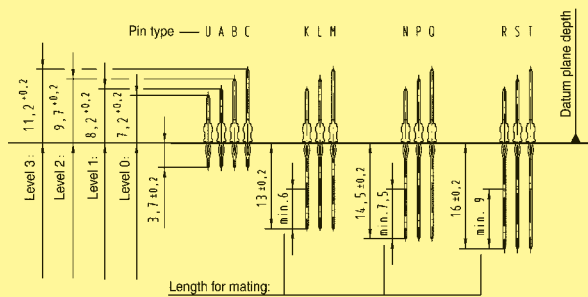

Connector dimensions [mm]

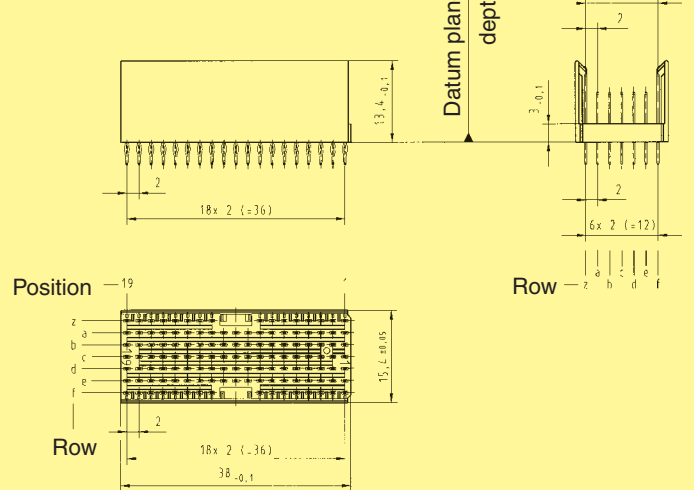

Board drillings

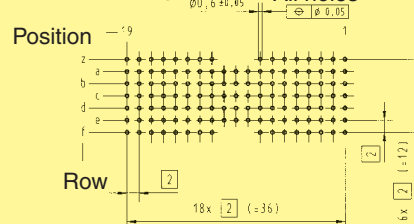

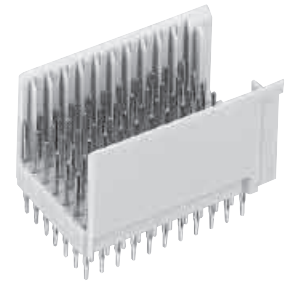

Male connectors, straight

Identification	Number of contacts	Contact length [mm]		Part number	Contact configuration
		mating side	termination side		
Type C	55	8.2	3.7	17 03 055 1201 <b>17 03 055 2201</b>	
Type C	77	8.2/ 11.2	3.7	17 03 077 1201 <b>17 03 077 2201</b>	
Type C	55	9.7	3.7	17 03 055 1202 <b>17 03 055 2202</b>	
Type C	77	9.7/ 11.2	3.7	17 03 077 1202 <b>17 03 077 2202</b>	
Type C	55	8.2	13.0	17 03 055 1401 <b>17 03 055 2401</b>	
Type C	66	8.2/ 11.2	13.0/ 16.0	17 03 066 1001 <b>17 03 066 2001</b>	



Male connectors, straight

Identification	Number of contacts	Contact length [mm] mating side	termination side	Part number	Contact configuration
Type C	77	8.2/ 11.2	3.7/ 13.0	17 03 077 1001 <b>17 03 077 2001</b>	
Type C	77	8.2/ 11.2	16.0	17 03 077 1601 <b>17 03 077 2601</b>	

Contact dimensions [mm]

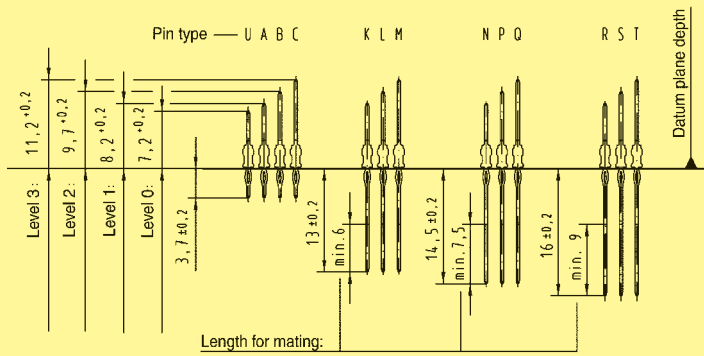

Connector dimensions [mm]

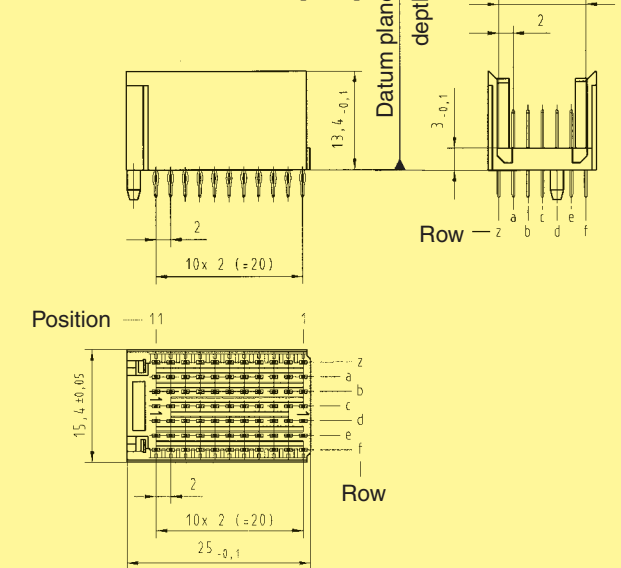

Board drillings

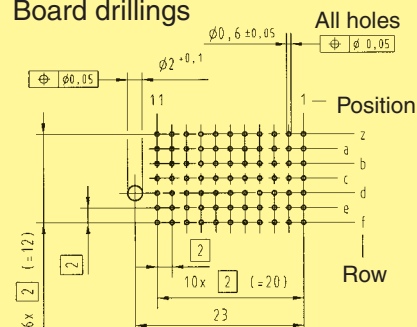

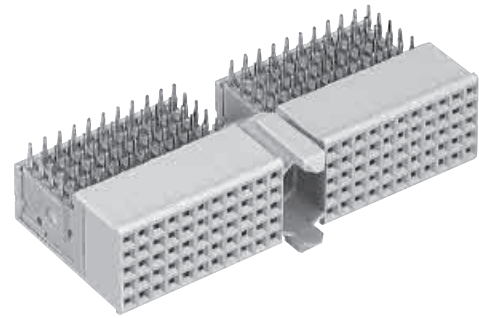

Female connectors, angled

Identification	No. of contacts	Contact length [mm] termination side	Part number
Type A	110	3.4	17 21 110 1101 <b>17 21 110 2101</b>
Type A with upper shield CompactPCI Positions J1, J4	110	3.4	17 21 110 1102 <b>17 21 110 2102</b>
Lower shield for type A connectors			17 21 000 4102
Type A with split upper shield CompactPCI computer telephony Position J4	90	3.4	17 21 090 1103 <b>17 21 090 2103</b>
Lower shield for type A connectors (rows 1 – 5) CompactPCI computer telephony			17 29 000 4102
Lower shield for type A connectors (rows 15 – 25) CompactPCI computer telephony			17 23 000 4102

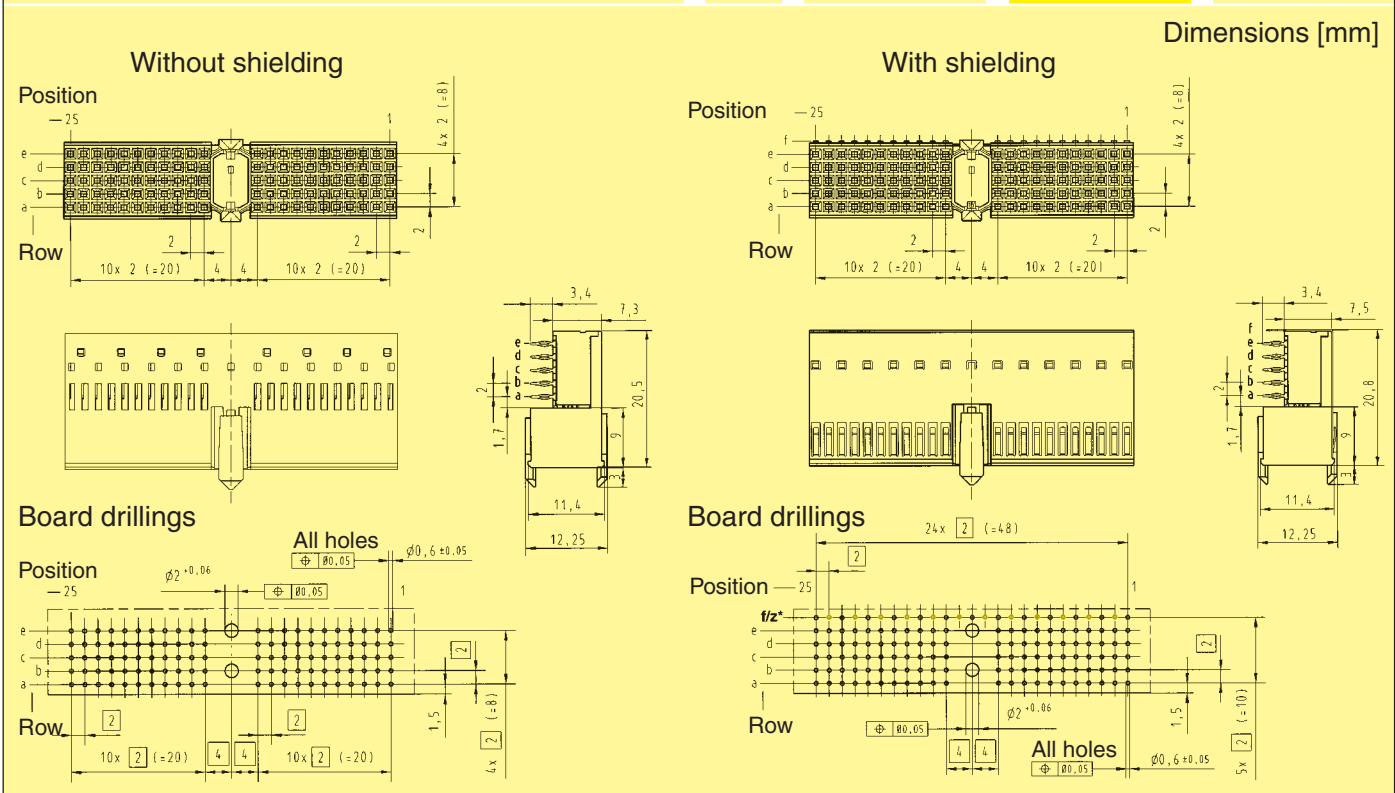

00  
24

Thin print part numbers: performance level 1  
**Bold print part numbers: performance level 2**

\* hole on even contact numbers  
 only needed for lower shielding

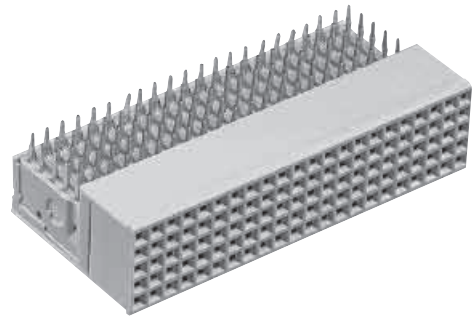

Female connectors, angled

Identification	No. of contacts	Contact length [mm] termination side	Part number
Type B19 VME, Position P0	95	3.4	17 25 095 1101 <b>17 25 095 2101</b>
Type B19 with upper shield CompactPCI, Position J3 – VME, Position P0	95	3.4	17 25 095 1102 <b>17 25 095 2102</b>
Lower shield for type B19 connectors			17 25 000 4102
Type B22	110	3.4	17 24 110 1101 <b>17 24 110 2101</b>
Type B22 with upper shield CompactPCI, Positions J2, J5	110	3.4	17 24 110 1102 <b>17 24 110 2102</b>
Lower shield for type B22 connectors			17 24 000 4102
Type B25	125	3.4	17 22 125 1101 <b>17 22 125 2101</b>
Type B25 with upper shield	125	3.4	17 22 125 1102 <b>17 22 125 2102</b>
Lower shield for type B25 connectors			17 22 000 4102

Contact positions	X <sub>1</sub>	X <sub>2</sub>
19	37.9	18 x $\frac{2}{2}$ (= 36)
22	43.9	21 x $\frac{2}{2}$ (= 42)
25	49.9	24 x $\frac{2}{2}$ (= 48)

Dimensions [mm]

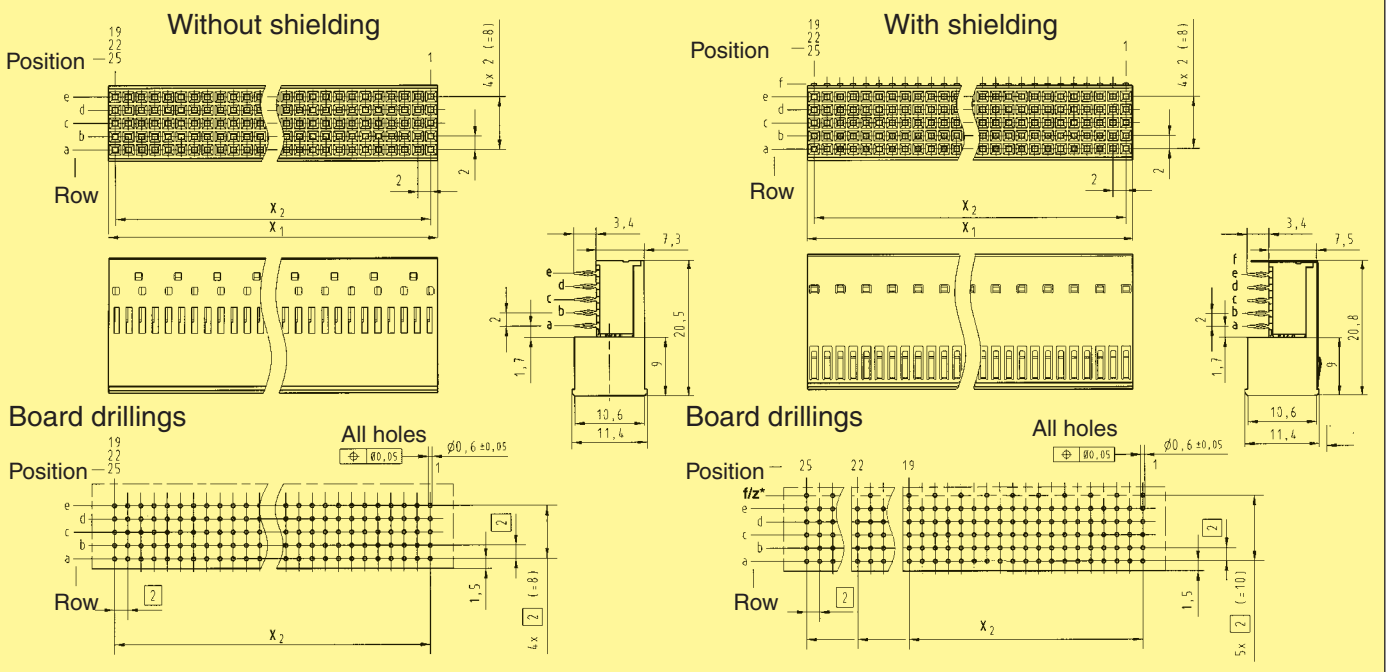

Thin print part numbers: performance level 1  
**Bold print part numbers: performance level 2**

\* hole on even contact numbers only needed for lower shielding

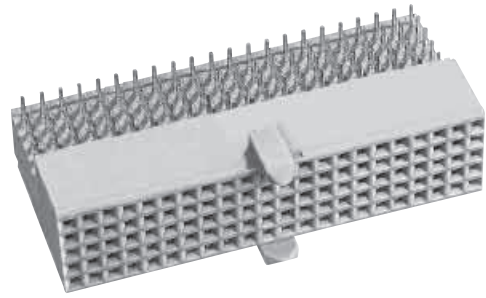

Female connectors, angled

Identification	No. of contacts	Contact length [mm] termination side	Part number
Type AB <sub>19</sub>	95	3.4	17 33 095 1101 <b>17 33 095 2101</b>
Type AB <sub>19</sub> with upper shield CompactPCI, Position RJ3	95	3.4	17 33 095 1102 <b>17 33 095 2102</b>
Lower shield for type AB <sub>19</sub> connectors			17 33 000 4102
Type AB <sub>22</sub>	110	3.4	17 34 110 1101 <b>17 34 110 2101</b>
Type AB <sub>22</sub> with upper shield CompactPCI, Positions RJ2, RJ5	110	3.4	17 34 110 1102 <b>17 34 110 2102</b>
Lower shield for type AB <sub>22</sub> connectors			17 34 000 4102
Type AB <sub>25</sub>	125	3.4	17 35 125 1101 <b>17 35 125 2101</b>
Type AB <sub>25</sub> with upper shield	125	3.4	17 35 125 1102 <b>17 35 125 2102</b>
Lower shield for type AB <sub>25</sub> connectors			17 21 000 4102

Contact positions	X <sub>1</sub>	X <sub>2</sub>
19	37.9	18 x <b>2</b> (= 36)
22	43.9	21 x <b>2</b> (= 42)
25	49.9	24 x <b>2</b> (= 48)

Dimensions [mm]

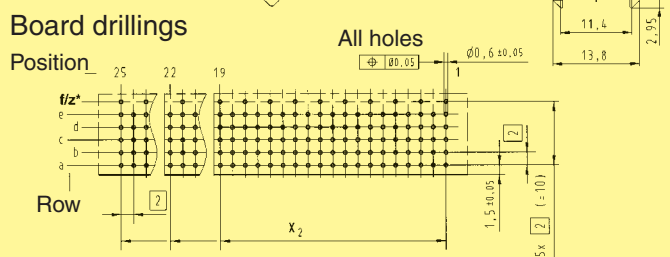
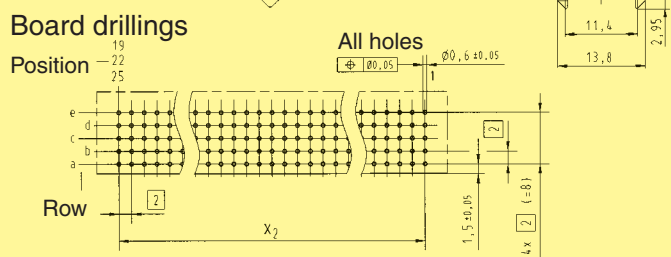
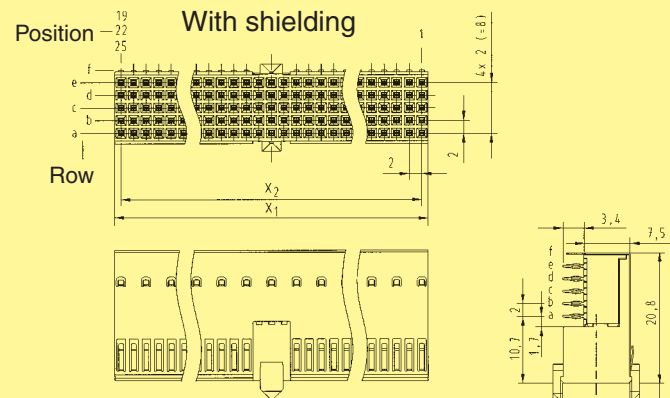
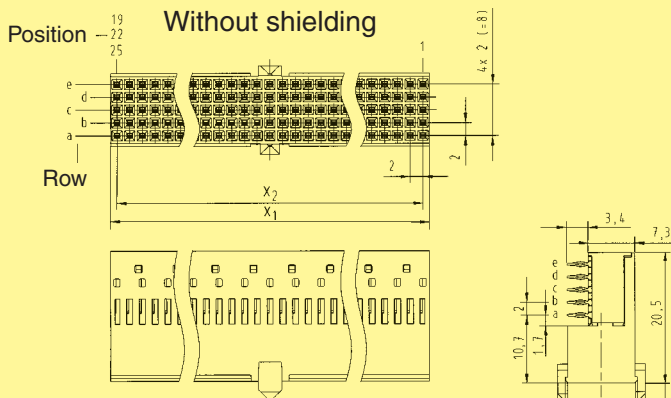



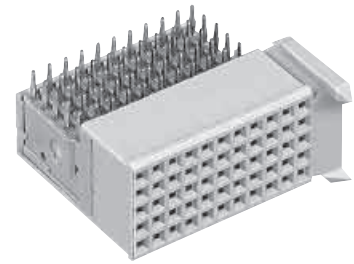

Female connectors, angled

Identification	No. of contacts	Contact length [mm] termination side	Part number
Type C	55	3.4	17 23 055 1101 17 23 055 2101
Type C with upper shield	55	3.4	17 23 055 1102 17 23 055 2102
Lower shield for type C connectors			17 23 000 4102

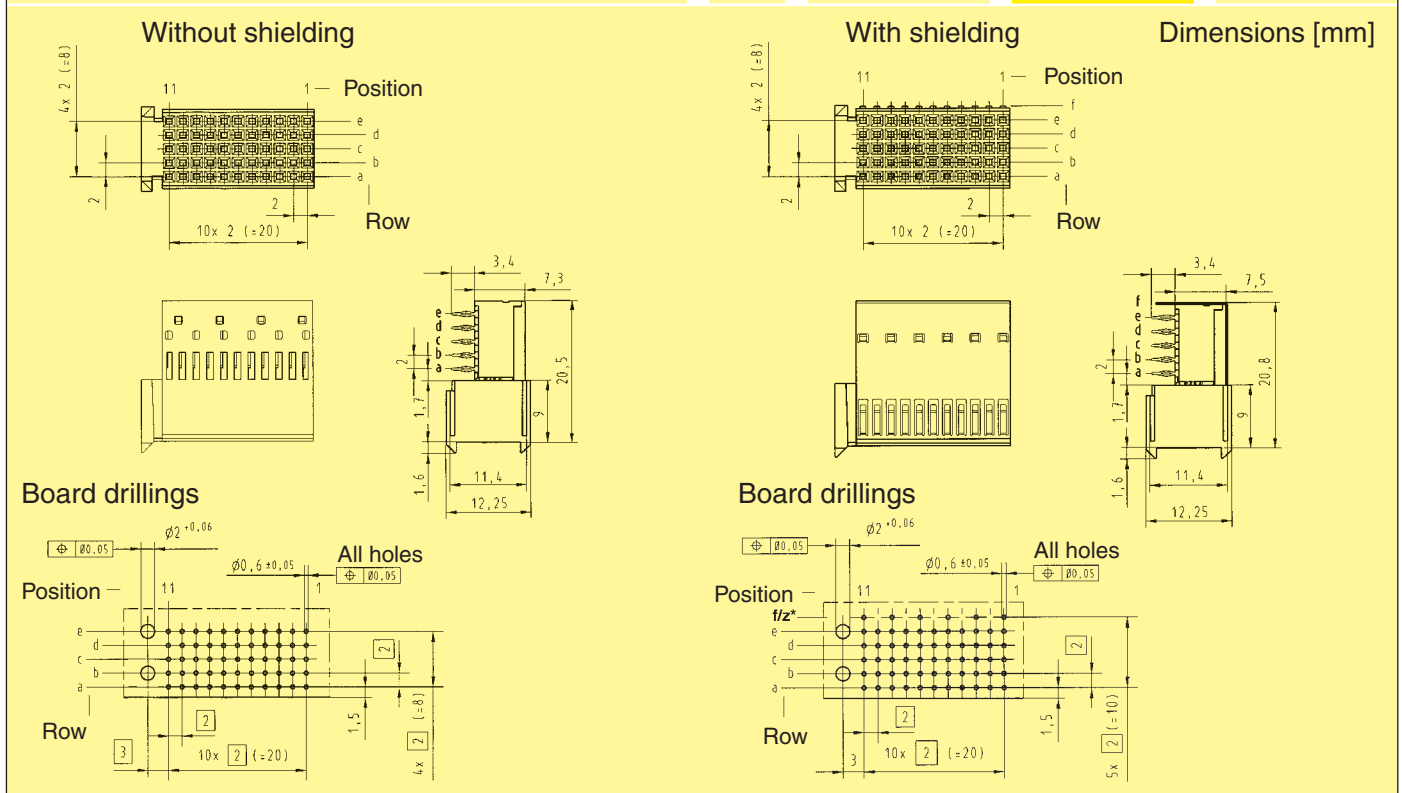

Thin print part numbers: performance level 1  
**Bold print part numbers: performance level 2**

\* hole on even contact numbers only needed for lower shielding

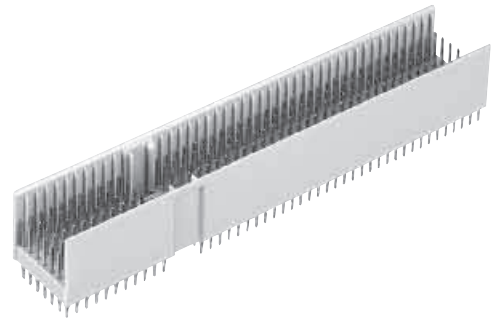

Male connectors, straight

Identification	Number of contacts	Contact length [mm] mating side	termination side	Part number	Contact configuration
Type Monoblock 47	220	8.2	3.7	17 06 220 1201 <b>17 06 220 2201</b>	
Type Monoblock 47	308	8.2/ 11.2	3.7	17 06 308 1201 <b>17 06 308 2201</b>	
Type Monoblock 47	220	9.7	3.7	17 06 220 1202 <b>17 06 220 2202</b>	
Type Monoblock 47 CompactPCI Positions P1 and P2	308	8.2/ 9.7/ 11.2	3.7	17 06 308 1202 <b>17 06 308 2202</b>	
Type Monoblock 47 CompactPCI hot swap	308	8.2/ 9.7/ 11.2	3.7	17 06 308 1203 <b>17 06 308 2203</b>	
Type Monoblock 47 CompactPCI computer telephony	232	8.2/ 9.7/ 11.2	3.7	17 06 232 1201 <b>17 06 232 2201</b>	

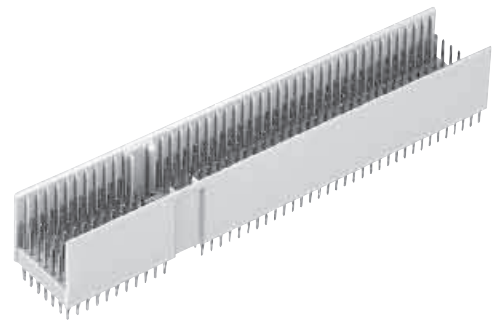

Male connectors, straight

Identification	Number of contacts	Contact length [mm] mating side	termination side	Part number	Contact configuration
Type Monoblock 47 CompactPCI I/O	308	8.2/ 9.7/ 11.2	3.7/ 16.0	17 06 308 1001 <b>17 06 308 2001</b>	
Type Monoblock 47 CompactPCI AB friendly Positions P4 and P5	308	9.7/ 11.2	3.7/ 16.0	17 06 308 1005 <b>17 06 308 2005</b>	

Contact dimensions [mm]

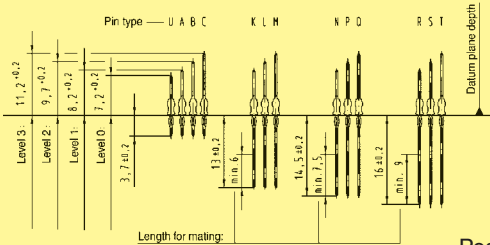

Connector dimensions [mm]

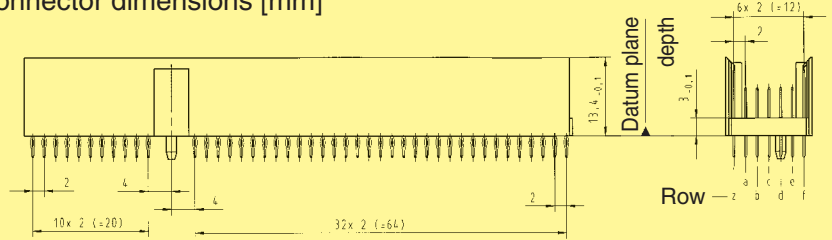

Position — 47

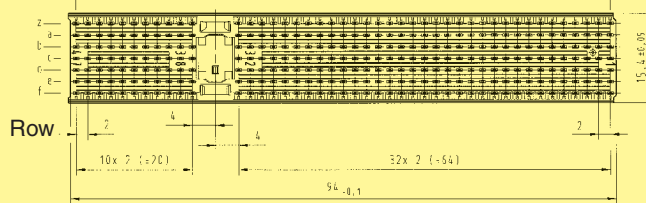

Board drillings

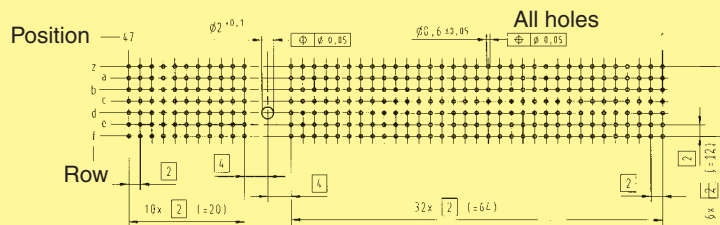

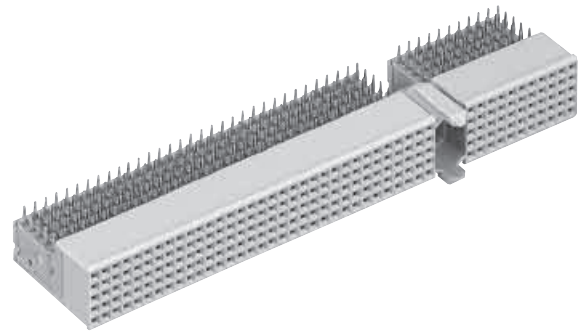

Female connectors, angled

Identification	No. of contacts	Contact length [mm] termination side	Part number
Type Monoblock 47	220	3.4	17 26 220 1101 <b>17 26 220 2101</b>
Type Monoblock 47 with upper shield	220	3.4	17 26 220 1102 <b>17 26 220 2102</b>
Type Monoblock 47 with upper shield CompactPCI computer telephony	200	3.4	17 26 200 1103 <b>17 26 200 2103</b>
Lower shield for type Monoblock 47 connectors			17 26 000 4102
Lower shield for type Monoblock 47 connectors (rows 1 – 22) CompactPCI computer telephony			17 24 000 4102
Lower shield for type Monoblock 47 connectors (rows 23 – 27) CompactPCI computer telephony			17 29 000 4102
Lower shield for type Monoblock 47 connectors (rows 37 – 47) CompactPCI computer telephony			17 23 000 4102

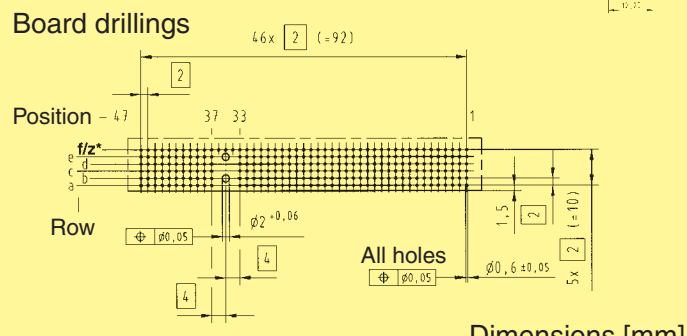
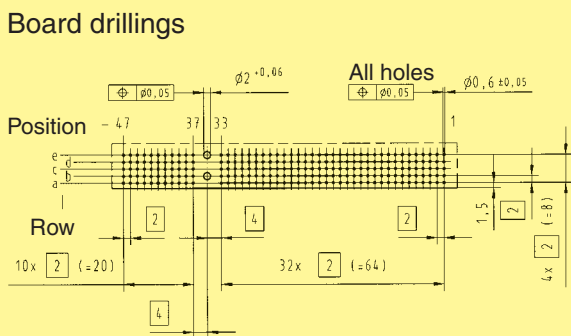
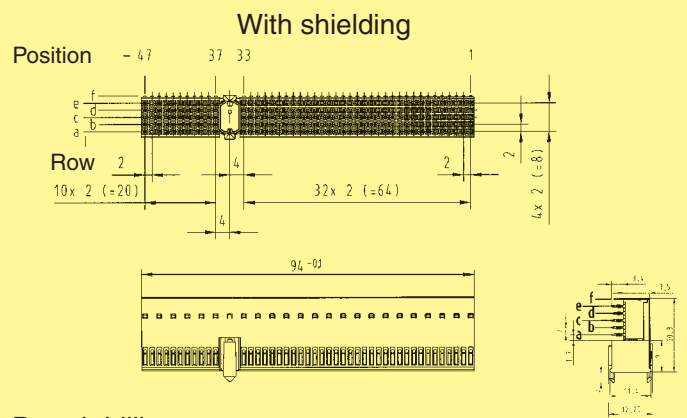
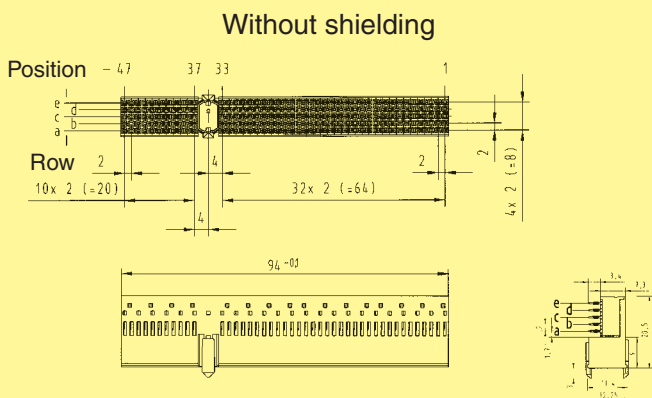

Dimensions [mm]

Thin print part numbers: performance level 1  
**Bold print part numbers: performance level 2**

\* hole on even contact numbers only needed for lower shielding



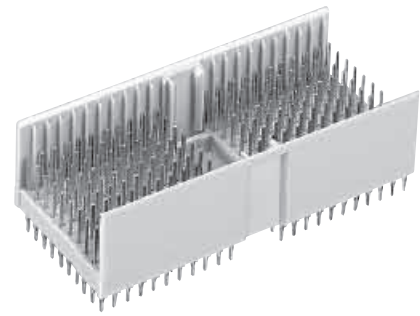

Male connectors, straight

Identification	Number of contacts	Contact length [mm] mating side	termination side	Part number	Contact configuration
Type D	176	8.2	3.7	17 11 176 1201 17 11 176 2201	
Type D	220	8.2/ 11.2	3.7	17 11 220 1201 17 11 220 2201	
Type D	220	9.7/ 11.2	14.5/ 16.0	17 11 220 1001 17 11 220 2001	

Contact dimensions [mm]

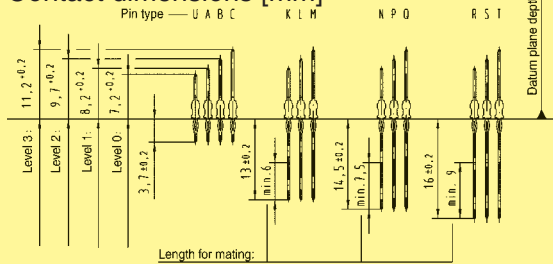

Connector dimensions [mm]

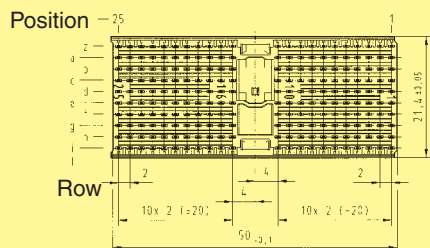
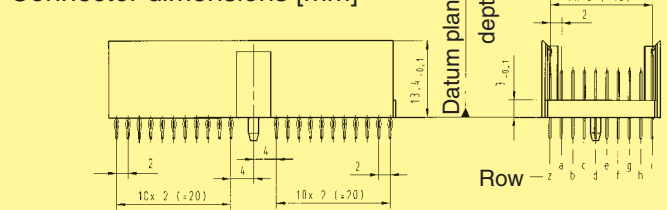

Board drillings

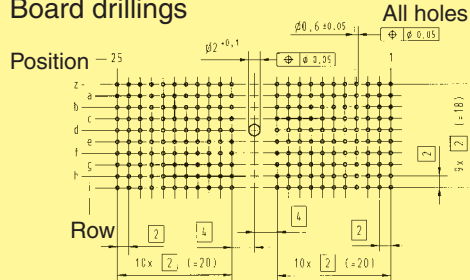

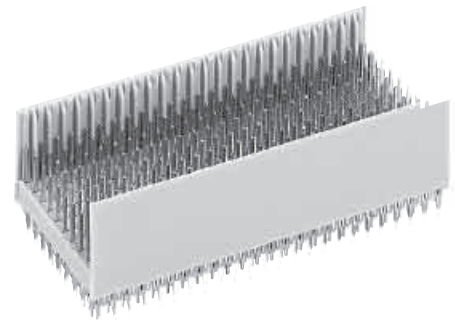

Male connectors, straight

Identification	Number of contacts	Contact length [mm] mating side	termination side	Part number	Contact configuration
Type E	200	8.2	3.7	17 12 200 1201 <b>17 12 200 2201</b>	
Type E	250	8.2/ 11.2	3.7	17 12 250 1201 <b>17 12 250 2201</b>	
Type E	250	9.7/ 11.2	14.5/ 16.0	17 12 250 1001 <b>17 12 250 2001</b>	

Contact dimensions [mm]

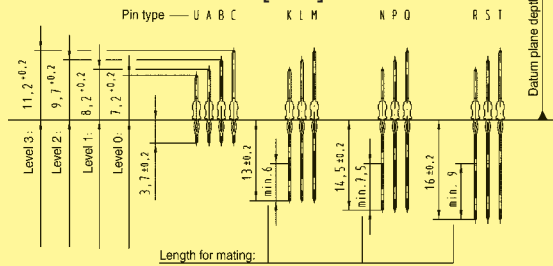

Connector dimensions [mm]

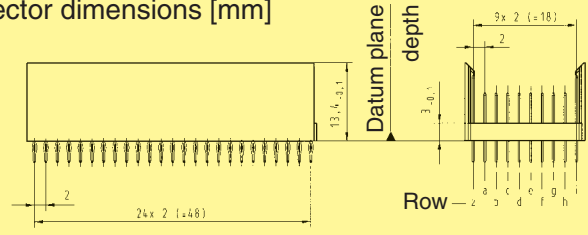

Position

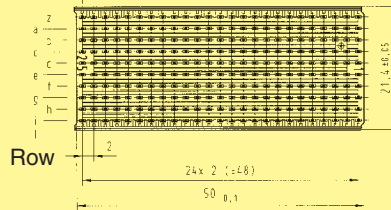

Board drillings

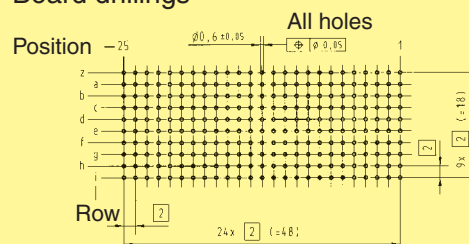

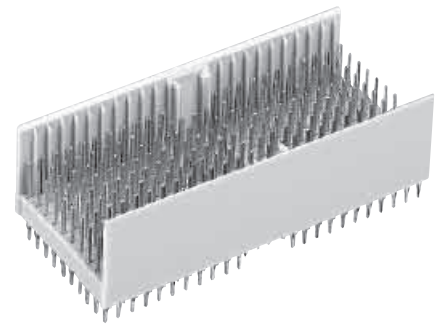

Male connectors, straight

Identification	Number of contacts	Contact length [mm] mating side	termination side	Part number	Contact configuration
Type DE	200	8.2	3.7	17 10 200 1201 <b>17 10 200 2201</b>	
Type DE	244	8.2/ 11.2	3.7	17 10 244 1201 <b>17 10 244 2201</b>	
Type DE	244	9.7/ 11.2	14.5/ 16.0	17 10 244 1001 <b>17 10 244 2001</b>	

Contact dimensions [mm]

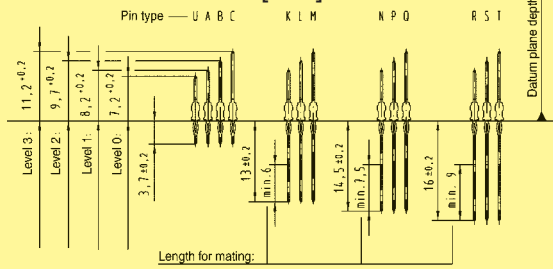

Connector dimensions [mm]

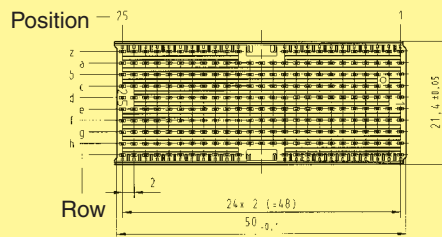
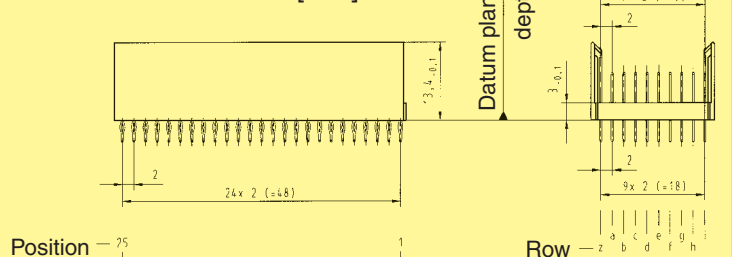

Board drillings

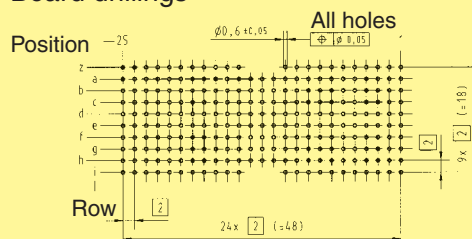



Coding keys are used to prevent mismatching of boards. They can be inserted into the multifunctional area of male and female connectors with special tooling. This can be easily done after the connectors have been pressed in.

Coding keys have different bright and pre-defined RAL colours to simplify the identification. In the table below the colours and code numbers in acc. with the IEC 61076-4-101 are listed. They are used for the following applications:

- Cadmium yellow for CompactPCI to identify 3.3 V bus signalling
- Brilliant blue for CompactPCI to identify 5.0 V bus signalling
- Reseda green to prevent accidental board insertion in VME64x on CompactPCI applications
- Strawberry red to prevent accidental board insertion in telephony applications
- Pastel orange for user defined bus
- Nut brown for rear I/O and user I/O

Coding keys for male connectors

Coding keys for female connectors

Coding key	Code number	Colour	Part number
	3568	Pastel orange RAL 2003	17 79 000 0010
	3467	Slate grey RAL 7015	17 79 000 0012
	3456	Cadmium yellow RAL 1021 for CPCI, 3.3 V	17 79 000 0013
	2578	Reseda green RAL 6011	17 79 000 0014
	1567	Brilliant blue RAL 5007 for CPCI, 5.0 V	17 79 000 0015
	1356	Blue lilac RAL 4005	17 79 000 0016
	1248	Strawberry red RAL 3018	17 79 000 0018
	1236	Nut brown RAL 8011	17 79 000 0019

Coding key	Code number	Colour	Part number
	1247	Pastel orange RAL 2003	17 79 000 0020
	1258	Slate grey RAL 7015	17 79 000 0022
	1278	Cadmium yellow RAL 1021 for CPCI, 3.3 V	17 79 000 0023
	1346	Reseda green RAL 6011	17 79 000 0024
	2348	Brilliant blue RAL 5007 for CPCI, 5.0 V	17 79 000 0025
	2478	Blue lilac RAL 4005	17 79 000 0026
	3567	Strawberry red RAL 3018	17 79 000 0028
	4578	Nut brown RAL 8011	17 79 000 0029

HARTING's *harbus® HM* shrouds protect the pins protruding the rear side of the backplane from irregular mating tolerances, thus ensuring a quality connection.

To accommodate pcb thickness, from 1.6 up to 4 mm nominal, the shrouds have integrated standoffs of corresponding height.

Thus forming a one piece solution that reduces assembling cost significantly.

The shroud can be mounted without the additional requirement of spacers to ensure the desired pin lengths on the rear side of the pcb.

Fixing of the component is carried out on the rear post via a smooth friction fit process.

For ease of assembly the same tooling as for the press-in connectors on the front side is utilised for assembly.

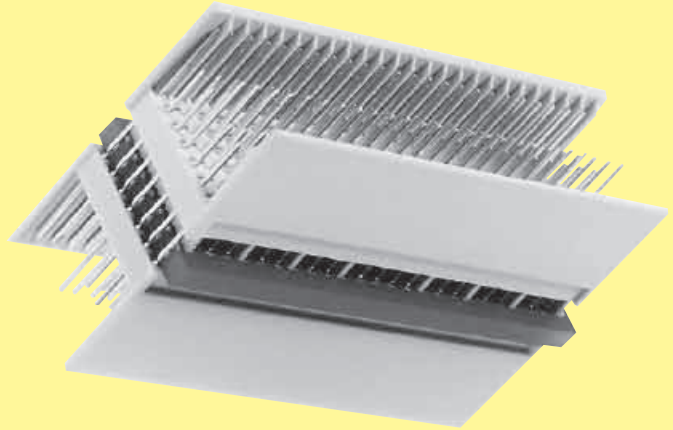

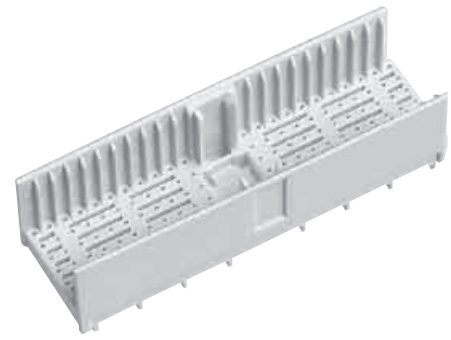

Identification

Board thickness [mm]

Part number

Type A shroud

25 positions

1.6 ± 0.4

2.4 ± 0.4

3.2 ± 0.4

4.0 ± 0.4

17 70 000 1001

17 70 000 1002

17 70 000 1003

17 70 000 1004

Dimensions

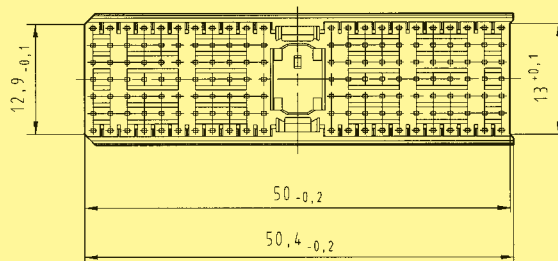
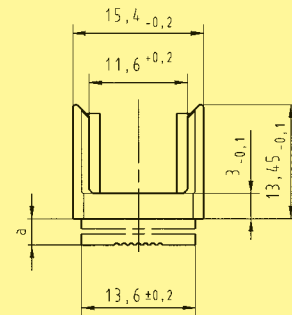
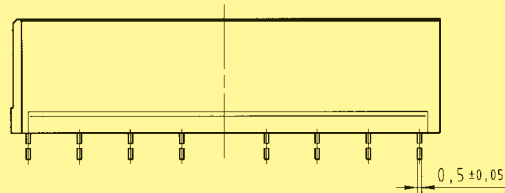
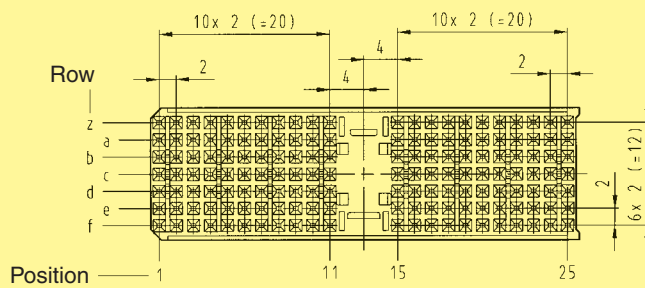

Board thickness [mm]	a [mm]
1.6 ± 0.4	3.1 ± 0.05
2.4 ± 0.4	2.3 ± 0.05
3.2 ± 0.4	1.5 ± 0.05
4.0 ± 0.4	0.7 ± 0.05



Identification	Board thickness [mm]	Part number
Type B shroud 25 positions	1.6 ± 0.4	17 70 000 2001
	2.4 ± 0.4	17 70 000 2002
	3.2 ± 0.4	17 70 000 2003
	4.0 ± 0.4	17 70 000 2004
22 positions	1.6 ± 0.4	17 70 000 4001
	2.4 ± 0.4	17 70 000 4002
	3.2 ± 0.4	17 70 000 4003
	4.0 ± 0.4	17 70 000 4004
19 positions	1.6 ± 0.4	17 70 000 5001
	2.4 ± 0.4	17 70 000 5002
	3.2 ± 0.4	17 70 000 5003
	4.0 ± 0.4	17 70 000 5004

Dimensions

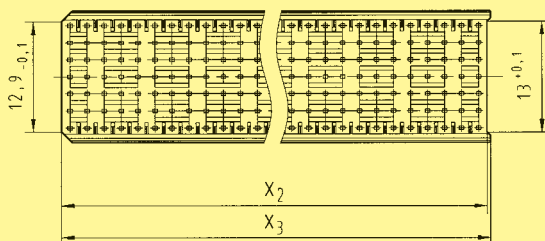
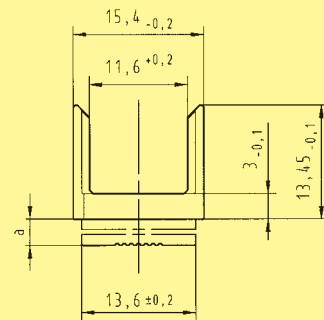
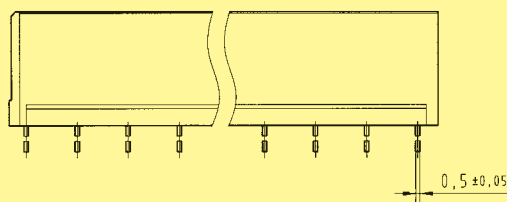
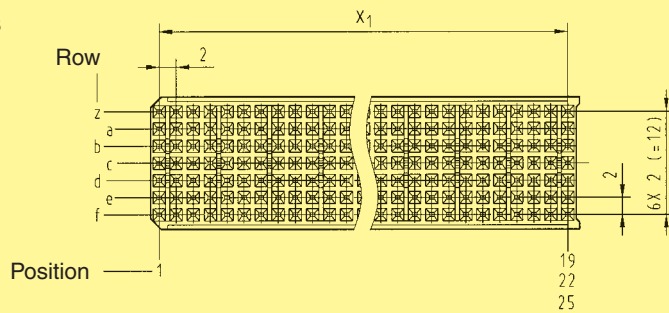

Board thickness [mm]	a [mm]
1.6 ± 0.4	3.1 ± 0.05
2.4 ± 0.4	2.3 ± 0.05
3.2 ± 0.4	1.5 ± 0.05
4.0 ± 0.4	0.7 ± 0.05

Contact positions	$x_1$ [mm]	$x_2$ [mm]	$x_3$ [mm]
19	18 x 2 (= 36)	38 - 0.2	38.4 - 0.2
22	21 x 2 (= 42)	44 - 0.2	44.4 - 0.2
25	24 x 2 (= 48)	50 - 0.2	50.4 - 0.2

Dimensions [mm]



Identification	Board thickness [mm]	Part number
Type AB shroud 25 positions	1.6 ± 0.4	17 70 000 8001
	2.4 ± 0.4	17 70 000 8002
	3.2 ± 0.4	17 70 000 8003
	4.0 ± 0.4	17 70 000 8004
22 positions	1.6 ± 0.4	17 70 000 7001
	2.4 ± 0.4	17 70 000 7002
	3.2 ± 0.4	17 70 000 7003
	4.0 ± 0.4	17 70 000 7004
19 positions	1.6 ± 0.4	17 70 000 6001
	2.4 ± 0.4	17 70 000 6002
	3.2 ± 0.4	17 70 000 6003
	4.0 ± 0.4	17 70 000 6004

Dimensions

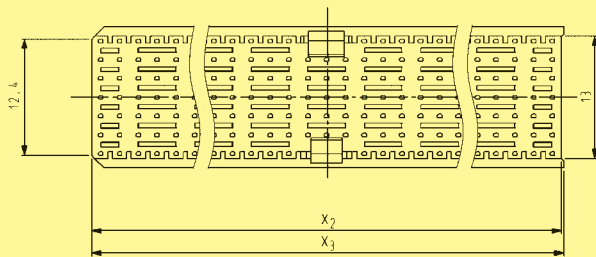
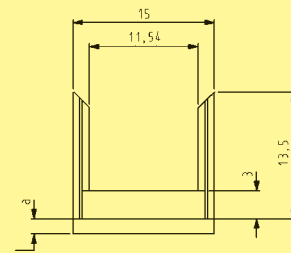
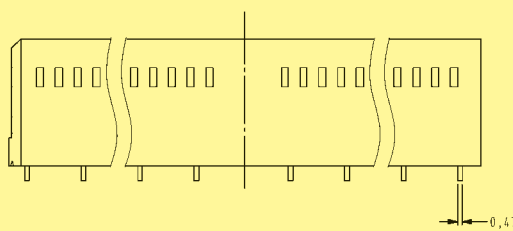
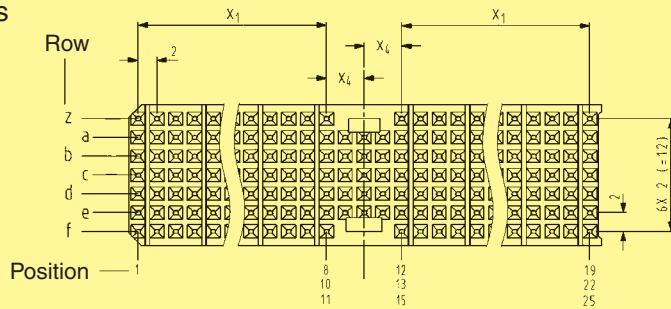

Board thickness [mm]	a [mm]
1.6 ± 0.4	3.1 ± 0.05
2.4 ± 0.4	2.3 ± 0.05
3.2 ± 0.4	1.5 ± 0.05
4.0 ± 0.4	0.7 ± 0.05

Contact positions	x <sub>1</sub> [mm]	x <sub>2</sub> [mm]	x <sub>3</sub> [mm]	x <sub>4</sub> [mm]
19	7 x 2 (= 14)	37.9	38.2	4
22	8 x 2 (= 16)	43.9	44.2	3
25	10 x 2 (= 20)	49.9	50.2	4

Dimensions [mm]



Identification

Board thickness [mm]

Part number

Type C shroud

11 positions

1.6 ± 0.4

2.4 ± 0.4

3.2 ± 0.4

4.0 ± 0.4

17 70 000 3001

17 70 000 3002

17 70 000 3003

17 70 000 3004

Dimensions

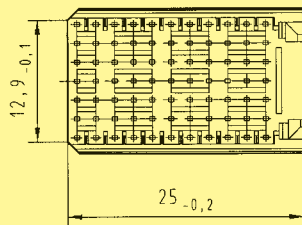
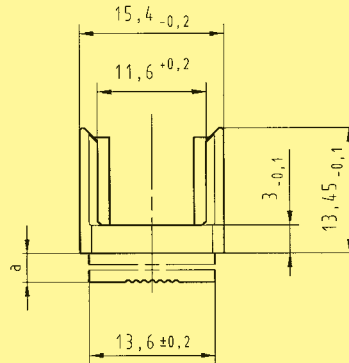
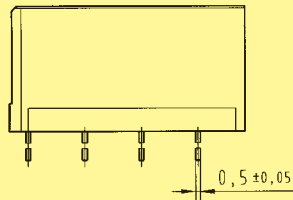
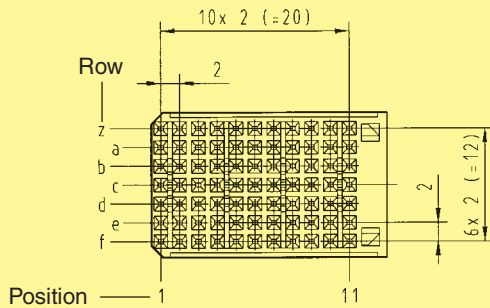

Board thickness [mm]	a [mm]
1.6 ± 0.4	3.1 ± 0.05
2.4 ± 0.4	2.3 ± 0.05
3.2 ± 0.4	1.5 ± 0.05
4.0 ± 0.4	0.7 ± 0.05



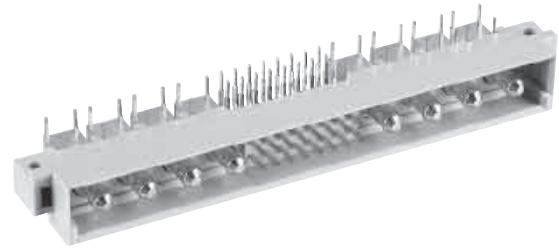

## DIN 41 612 Type M male connectors

Identification	Number of contacts	Contact arrangement	Part No.	Performance levels according to IEC 60 603-2		
				3	2	1
Male connector with angled solder pins	24 + 8		09 03 124 7901	09 03 124 6901	09 03 124 2901	

### Dimensions

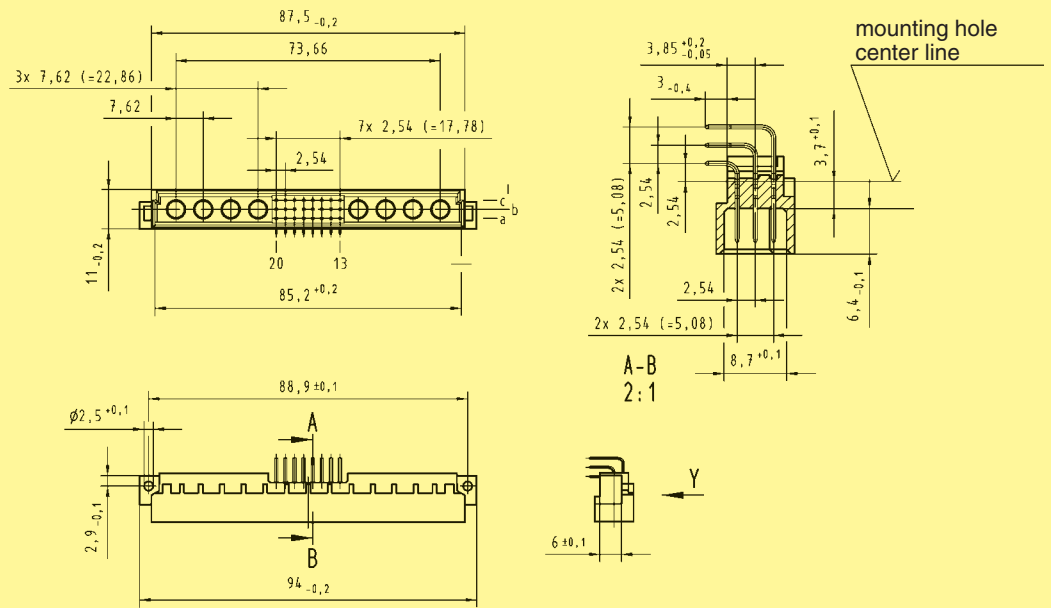

**Order high current, high voltage and coaxial contacts separately, see page 00.44**

### Board drillings Mounting side

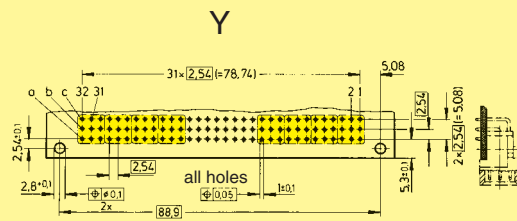

Board drillings depend on type and special contact loading

Dimensions in mm





## DIN 41612 Complementary type M-flat female connectors

Identification	Number of contacts	Contact arrangement	Performance levels according to IEC 60603-2		
			Part No. 3	2	1
Female connector with press-in terminations 4.5 mm	24 + 8		Performance level 3 on request	09 03 224 6830	Performance level 1 on request
High current female contact with press-in termination		30 A	09 03 000 6250		

### Dimensions

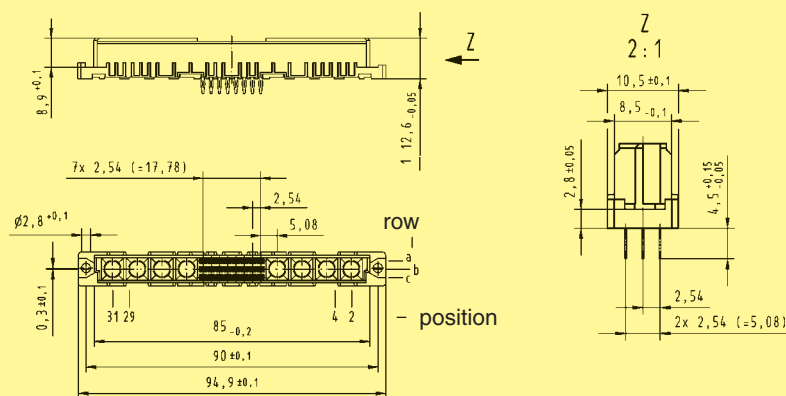

Order high current, high voltage and coaxial contacts separately, see page 00.44

### Panel cut out

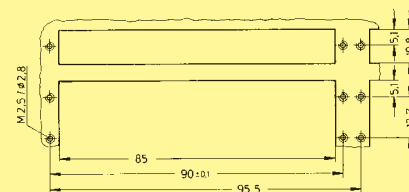

### Board drillings

Mounting side

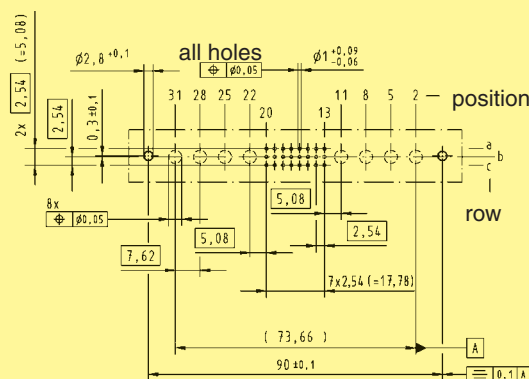























Recommended configuration of plated through holes (signal contacts) see chapter 05

Dimensions in mm

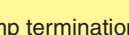
## Contacts

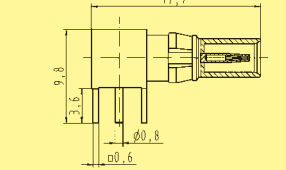
harcibus<sup>®</sup> HM

Identification	Part No. Performance level 2	Drawing	Dimensions in mm												
<b>High current male contacts for female moulding angled</b>  for straight crimp termination  10 A 09 03 000 6113 20 A 09 03 000 6114 40 A 09 03 000 6115		 <table border="1" data-bbox="1241 365 1425 488"> <thead> <tr> <th></th> <th>ø A</th> <th>ø B</th> </tr> </thead> <tbody> <tr> <td>10 A</td> <td>1.85</td> <td>2.55</td> </tr> <tr> <td>20 A</td> <td>2.85</td> <td>3.70</td> </tr> <tr> <td>40 A</td> <td>4.40</td> <td>5.60</td> </tr> </tbody> </table>		ø A	ø B	10 A	1.85	2.55	20 A	2.85	3.70	40 A	4.40	5.60	
	ø A		ø B												
10 A	1.85		2.55												
20 A	2.85	3.70													
40 A	4.40	5.60													
for straight solder termination   10 A 09 03 000 6101 20 A 09 03 000 6102 40 A 09 03 000 6103		 <table border="1" data-bbox="1241 521 1361 633"> <thead> <tr> <th></th> <th>ø</th> </tr> </thead> <tbody> <tr> <td>10 A</td> <td>1.7</td> </tr> <tr> <td>20 A</td> <td>2.8</td> </tr> <tr> <td>40 A</td> <td>4.8</td> </tr> </tbody> </table>		ø	10 A	1.7	20 A	2.8	40 A	4.8					
	ø														
10 A	1.7														
20 A	2.8														
40 A	4.8														
for angled pcb termination  40 A 09 03 000 6104															
<b>High current female contacts for male moulding straight<sup>1)</sup></b>  for straight crimp termination  10 A 09 03 000 6213 20 A 09 03 000 6214 40 A 09 03 000 6215		 <table border="1" data-bbox="1241 857 1425 981"> <thead> <tr> <th></th> <th>ø A</th> <th>ø B</th> </tr> </thead> <tbody> <tr> <td>10 A</td> <td>1.85</td> <td>2.55</td> </tr> <tr> <td>20 A</td> <td>2.80</td> <td>3.70</td> </tr> <tr> <td>40 A</td> <td>4.40</td> <td>5.60</td> </tr> </tbody> </table>		ø A	ø B	10 A	1.85	2.55	20 A	2.80	3.70	40 A	4.40	5.60	
	ø A		ø B												
10 A	1.85		2.55												
20 A	2.80	3.70													
40 A	4.40	5.60													
for straight solder termination   10 A 09 03 000 6201 20 A 09 03 000 6202 40 A 09 03 000 6203		 <table border="1" data-bbox="1241 1003 1361 1115"> <thead> <tr> <th></th> <th>ø</th> </tr> </thead> <tbody> <tr> <td>10 A</td> <td>1.7</td> </tr> <tr> <td>20 A</td> <td>2.8</td> </tr> <tr> <td>40 A</td> <td>4.8</td> </tr> </tbody> </table>		ø	10 A	1.7	20 A	2.8	40 A	4.8					
	ø														
10 A	1.7														
20 A	2.8														
40 A	4.8														
<b>High voltage male contact for male moulding straight<sup>2)</sup></b>  for straight solder termination  2.8 kV 09 03 000 6140															
<b>High voltage female contact for female moulding angled<sup>2)</sup></b>  for straight solder termination  2.8 kV 09 03 000 6240															
<b>Male coaxial contact 50 Ω for male moulding straight</b>  for straight solder and/or crimp termination  09 03 000 6160			for cables RG 174 A/U RG 188 A/U RG 316 U												
<b>Female coaxial contacts 50 Ω for female moulding angled</b>  for straight solder and/or crimp termination  09 03 000 6274			for cables RG 174 A/U RG 188 A/U RG 316 U												
angled for pcb termination  09 03 000 6262															
<b>Crimping tool for high current contacts</b>  09 99 000 0196															
<b>Crimping tool for coaxial contacts</b>  09 99 000 0194															

<sup>1)</sup> Contact resistance max. 1.5 mΩ

<sup>2)</sup> Contact resistance internal wire max. 3 mΩ  
Other contacts on request

## harbus® 64

### Male connectors

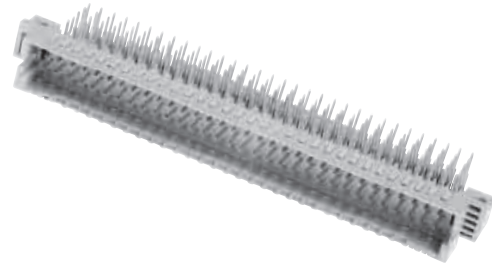

Identification	Number of contacts	Contact arrangement	Part No.	Performance levels according to IEC 61076-4-113
				2 1
Male connectors, angled <sup>1)</sup>				
SMC version with solder pins <sup>2)</sup>				
without retention clip	160	z, a, b, c, d	02 01 160 2101	02 01 160 1101
with retention clip	160	z, a, b, c, d	02 01 160 2102	02 01 160 1102

### Dimensions

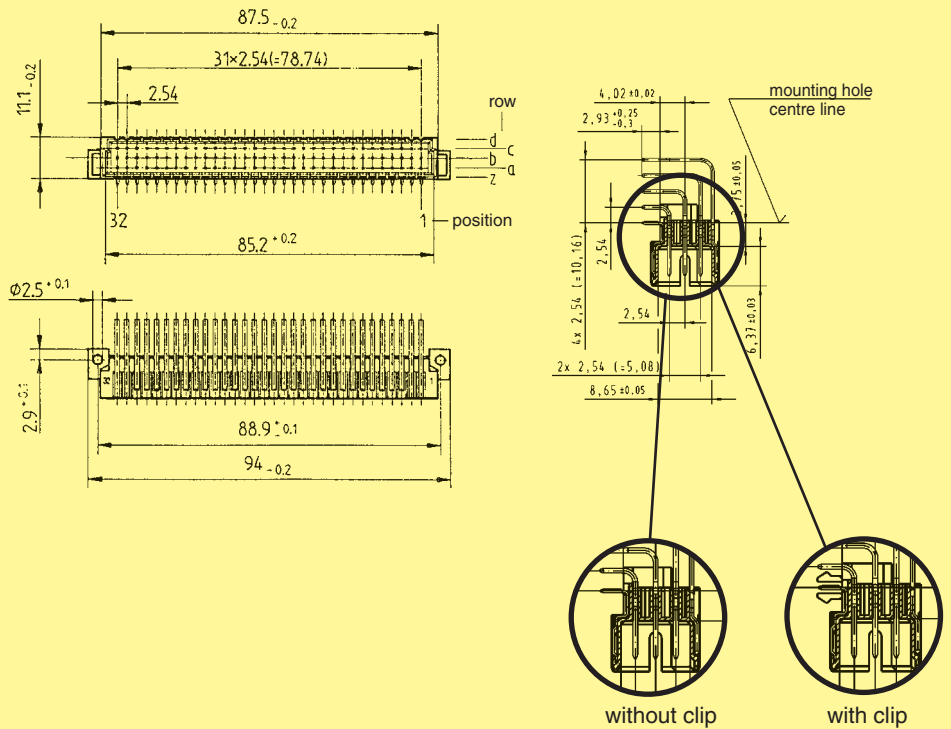

### Board drillings

Mounting side

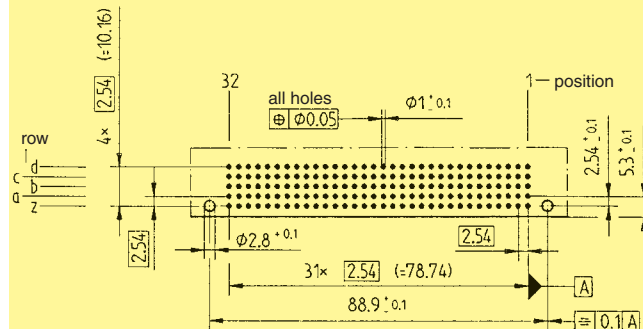

Dimensions in mm

<sup>1)</sup> Pre-leading contacts at positions d1, d2, d31 and d32

<sup>2)</sup> SMC see chapter 01

Further types see DIN 41 612 catalogue

## harbus<sup>®</sup> 64

### Female connectors

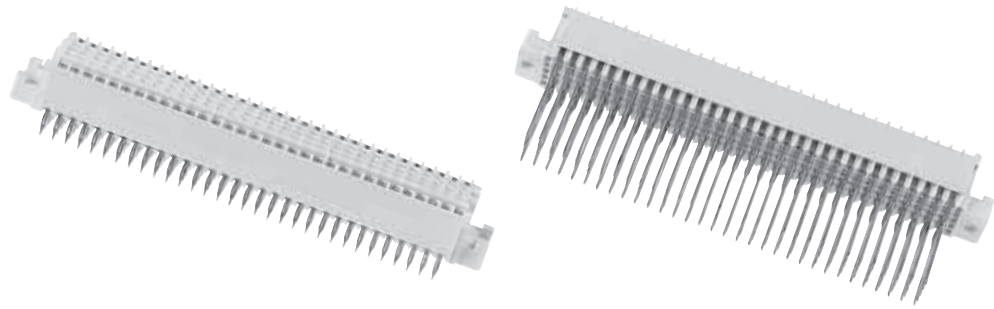

Identification	Number of contacts	Contact arrangement	Part No. Performance levels according to IEC 61 076-4-113 Explanation chapter 00	
			2	1
Female connectors, straight with press-in terminations				
with 3.7 mm fixing flange	160	z, a, b, c, d		02 02 160 1601
4.5/5 mm	160	z, a, b, c, d	02 02 160 2201	02 02 160 1201
17 mm*	160	z, a, b, c, d	02 02 160 2301	02 02 160 1301
without 5 mm fixing flange	160	z, a, b, c, d	02 02 160 2202	02 02 160 1202
17 mm*	160	z, a, b, c, d	02 02 160 2302	02 02 160 1302

### Dimensions

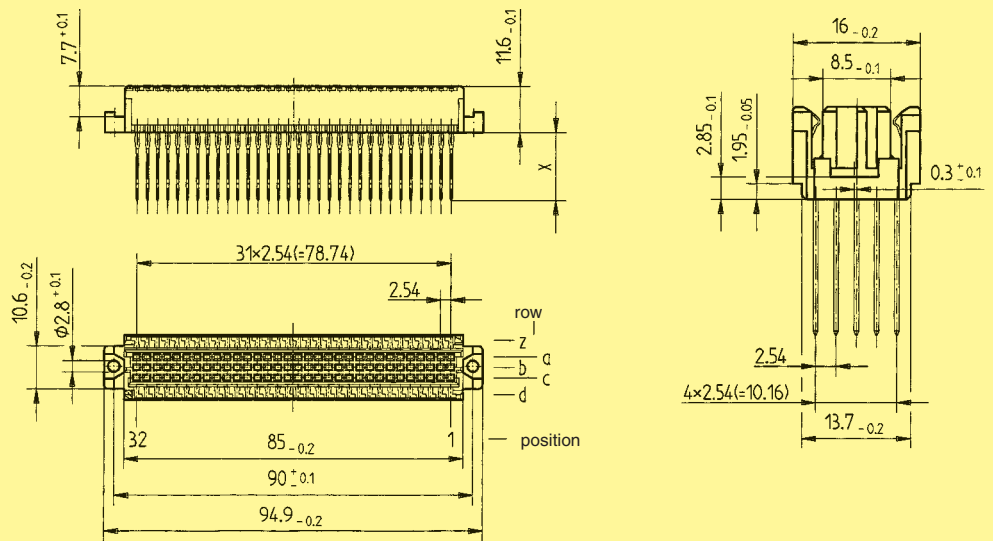

Part number	Dimension "X" for row				
	z	a	b	c	d
02 02 160 1601	3.7	3.7	3.7	3.7	3.7
02 02 160 2201 / 02 02 160 1201	5.0	4.5	4.5	4.5	5.0
02 02 160 2301 / 02 02 160 1301	17.0	17.0	17.0	17.0	17.0
02 02 160 2202 / 02 02 160 1202	5.0	5.0	5.0	5.0	5.0
02 02 160 2302 / 02 02 160 1302	17.0	17.0	17.0	17.0	17.0

### Board drillings

#### Mounting side

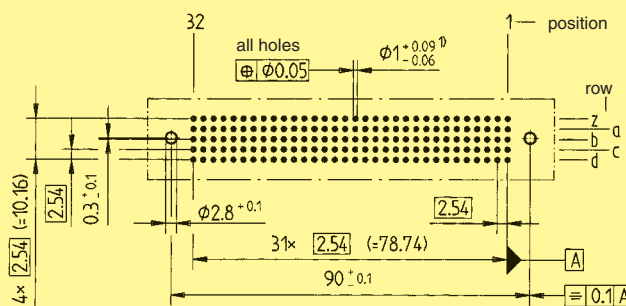

Recommended configuration of plated through holes see chapter 05

Dimensions in mm

1) Selectively gold-plated  
Further types see DIN 41 612 catalogue

## harbus® 64

### Female connectors

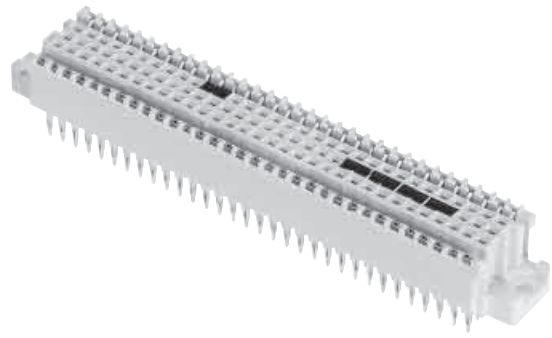

Identification	Number of contacts	Contact arrangement	Part No. Performance level 2 according to IEC 61076-4-113
Female connectors, straight with switches <sup>1)</sup>			
with press-in terminations			
with flange 4.5/5 mm	160	z, a, b, c, d	02 03 160 2201

### Dimensions

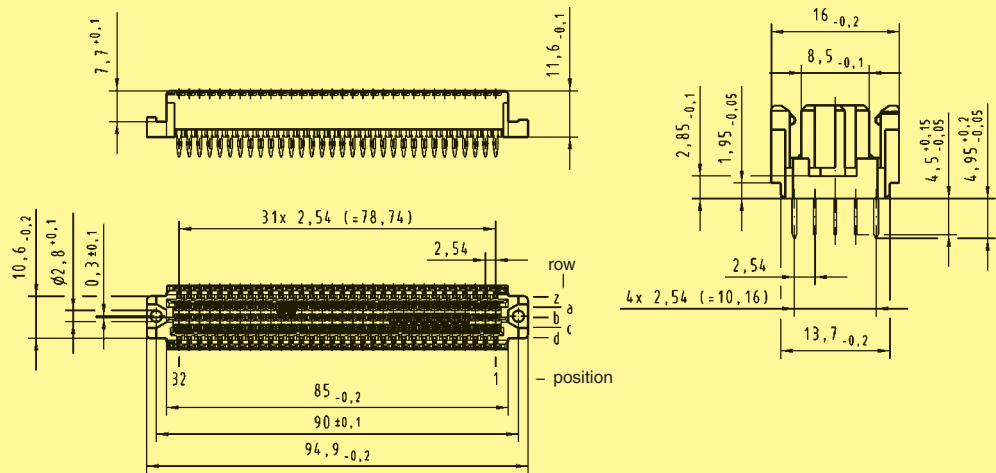

### Board drillings

Mounting side

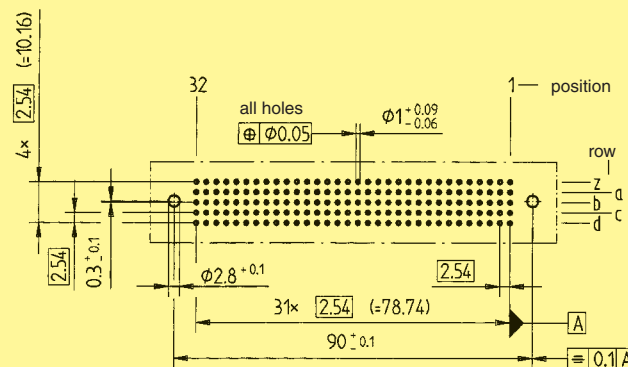

Recommended configuration of plated through holes see chapter 05

Dimensions in mm

<sup>1)</sup> Switching elements at positions a21-22, b4-5, b6-7, b8-9 and b10-11  
Further types see DIN 41612 catalogue

