

## SPECIFICATION

- Part No. : WPC.25A.07.0150C
- Product Name : 2.4GHz Ceramic Patch Antenna on integral ground with cable and connector
- Feature : High antenna RF efficiency  
150mm 1.13 IPEX MHFI  
RoHS compliant



## I Introduction

The WPC.25A 2.4GHz Ceramic Patch Antenna with cable works on Wi-Fi, Zigbee, Bluetooth and ISM band at 2.4GHz. This antenna comprises of a 2.4GHz 25\*25\*4mm embedded patch with mini-coax cable and connector for connectivity and a PCB carrier to mount the antenna. The WPC.25A is circularly polarized which is more suitable to avoid interference and phase cancellation from reflections. The antenna has its own ground PCB carrier and is therefore ground independent.

## II Specification

Wi-Fi	
Frequency (MHz)	2400~2500
Peak Gain (dBi)	> 0.5
Average Gain (dBi)	> -2.5
Efficiency (%)	> 50
Impedance	50Ω
Polarization	RHCP
Input Power	10 W
MECHANICAL	
Dimensions	25*25*5.5mm
Cable type	1.37 mini coaxial cable
Cable length	150mm
Connector	IPEX MHF1
ENVIRONMENTAL	
Temperature Range	-40°C to 85°C
Humidity	Non-condensing 65°C 95% RH

### III Antenna Characteristics

#### III.1 Return loss

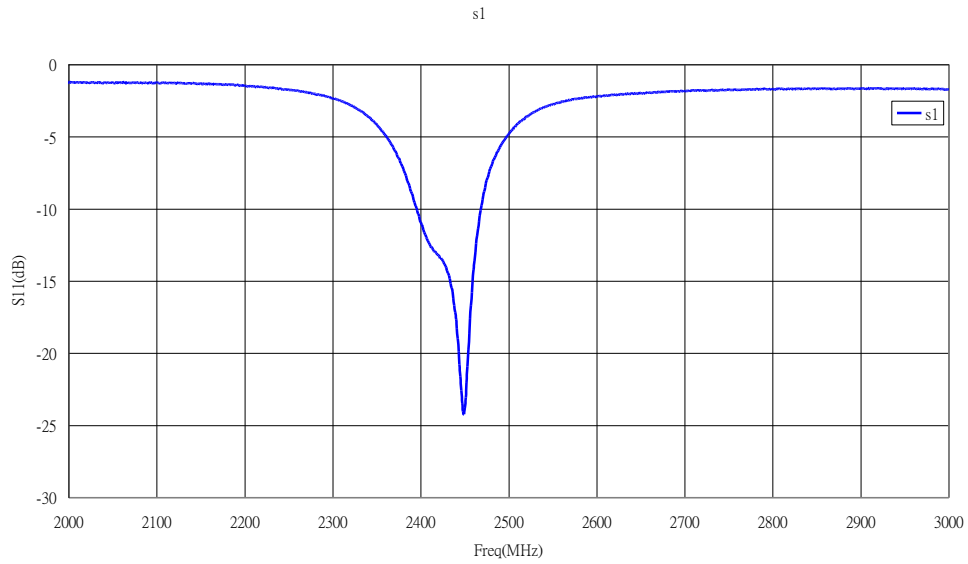

#### III.2 Antenna Efficiency

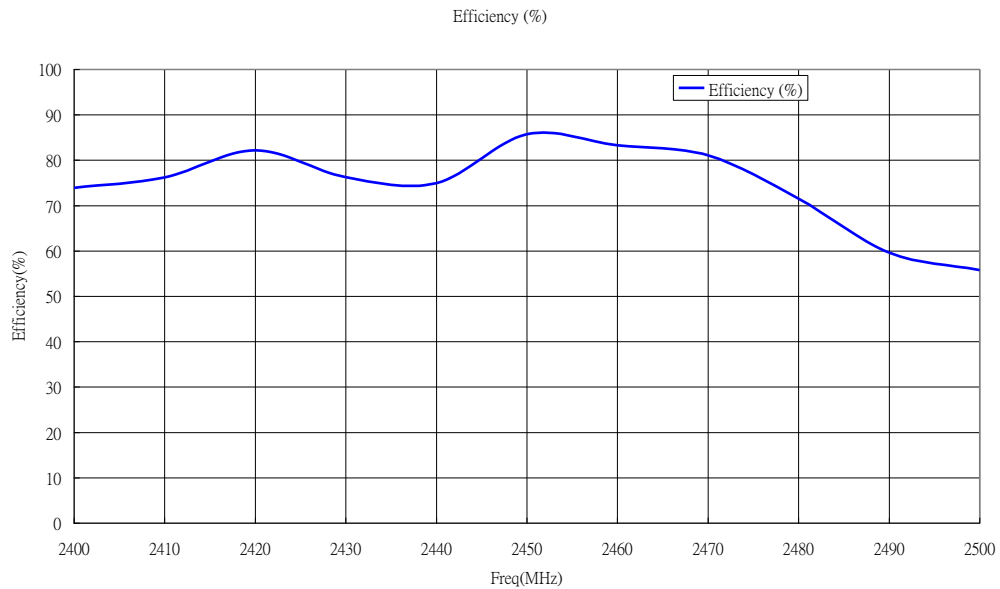

### III.3 Peak Gain

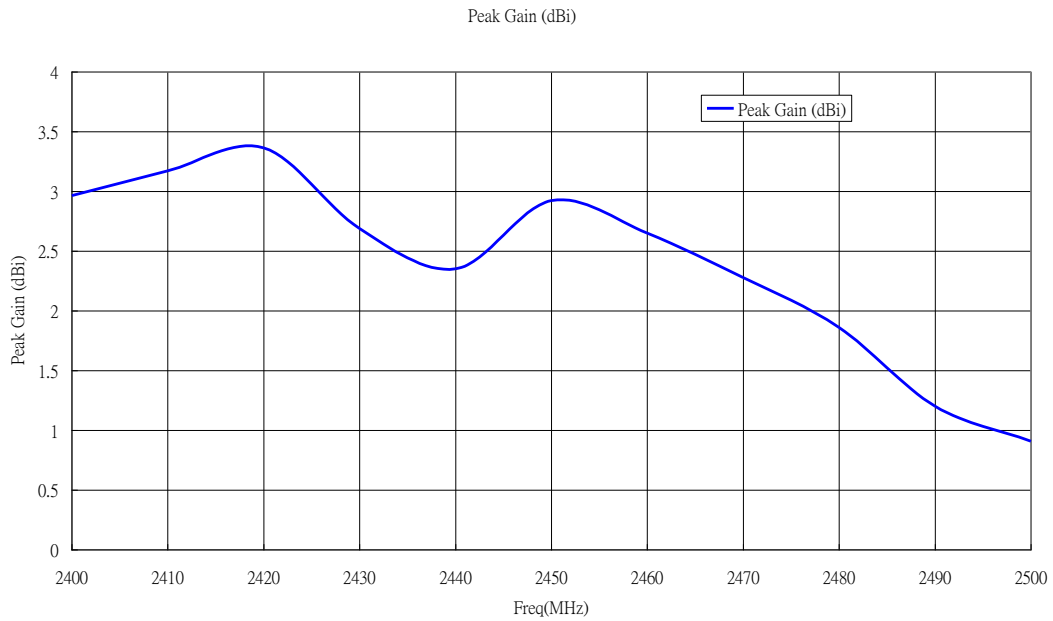

## IV Antenna Radiation Pattern

### IV.1 Antenna Stand Alone

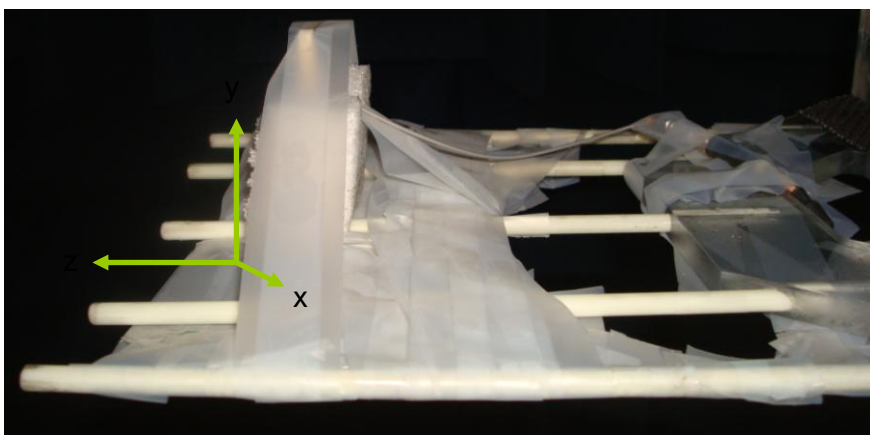

## IV.2 XZ plane

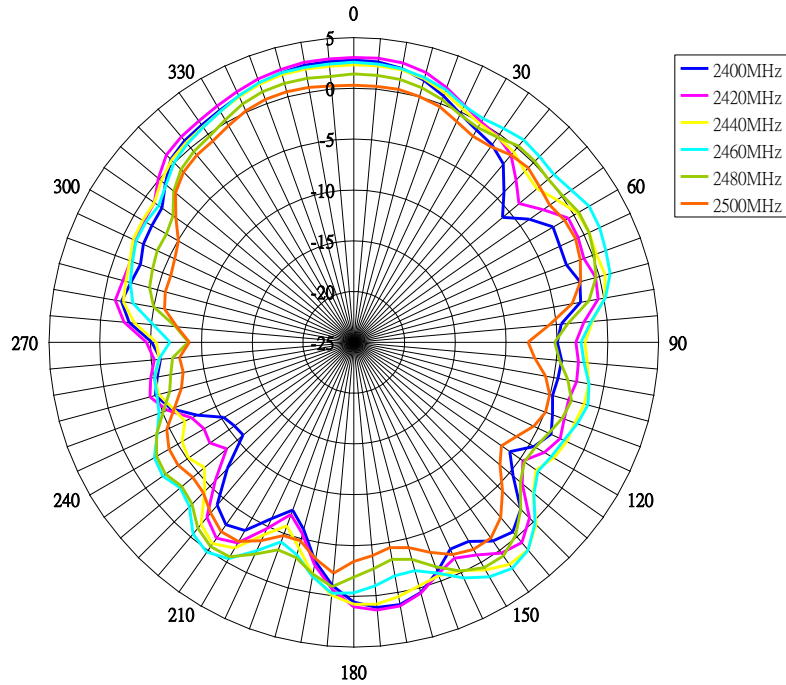

## IV.3 YZ plane

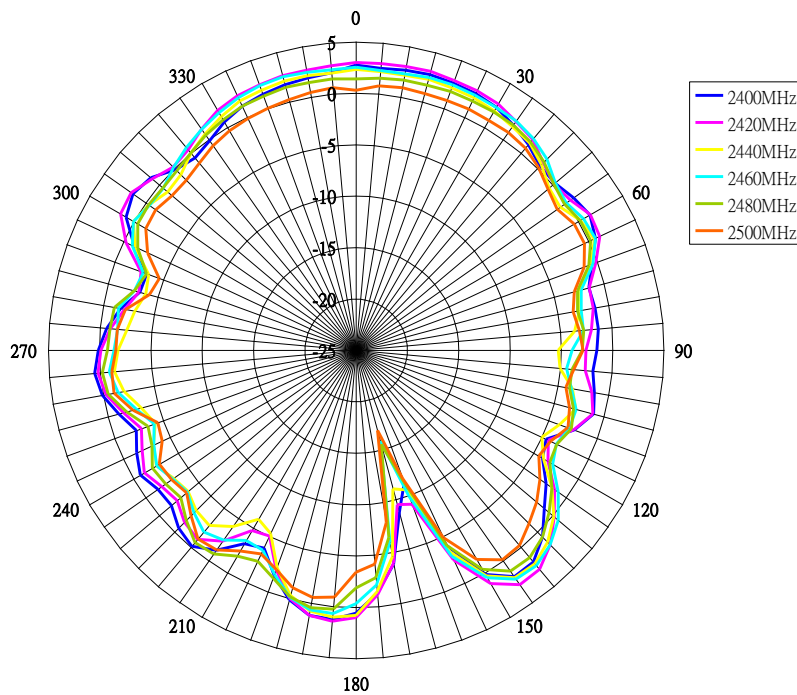

## IV.4 XY plane

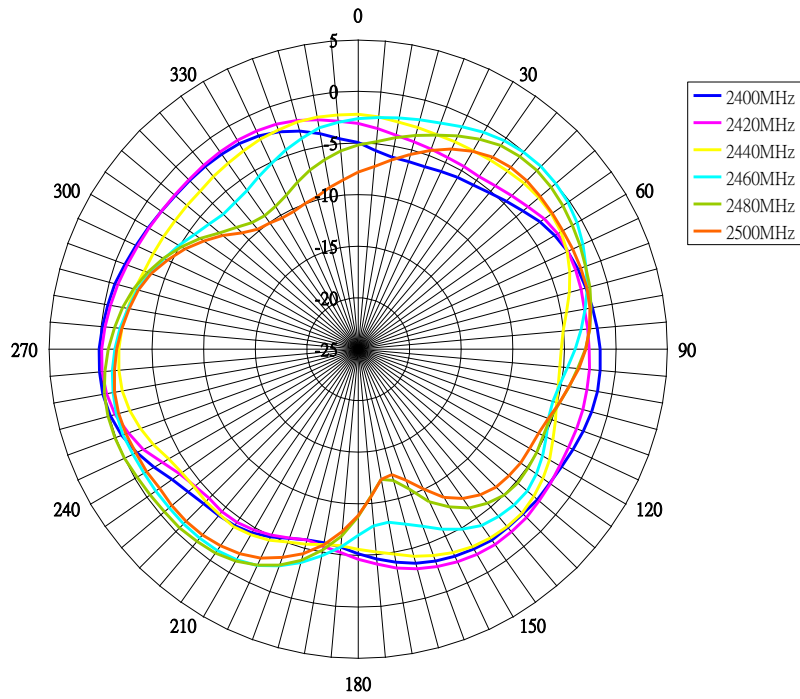

## V Mechanical Drawing

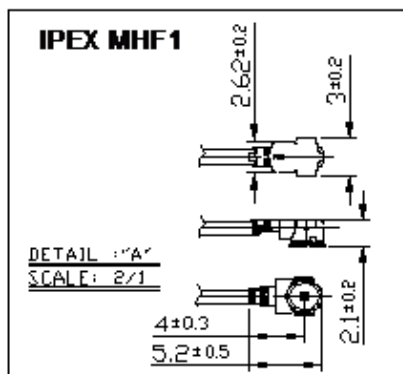
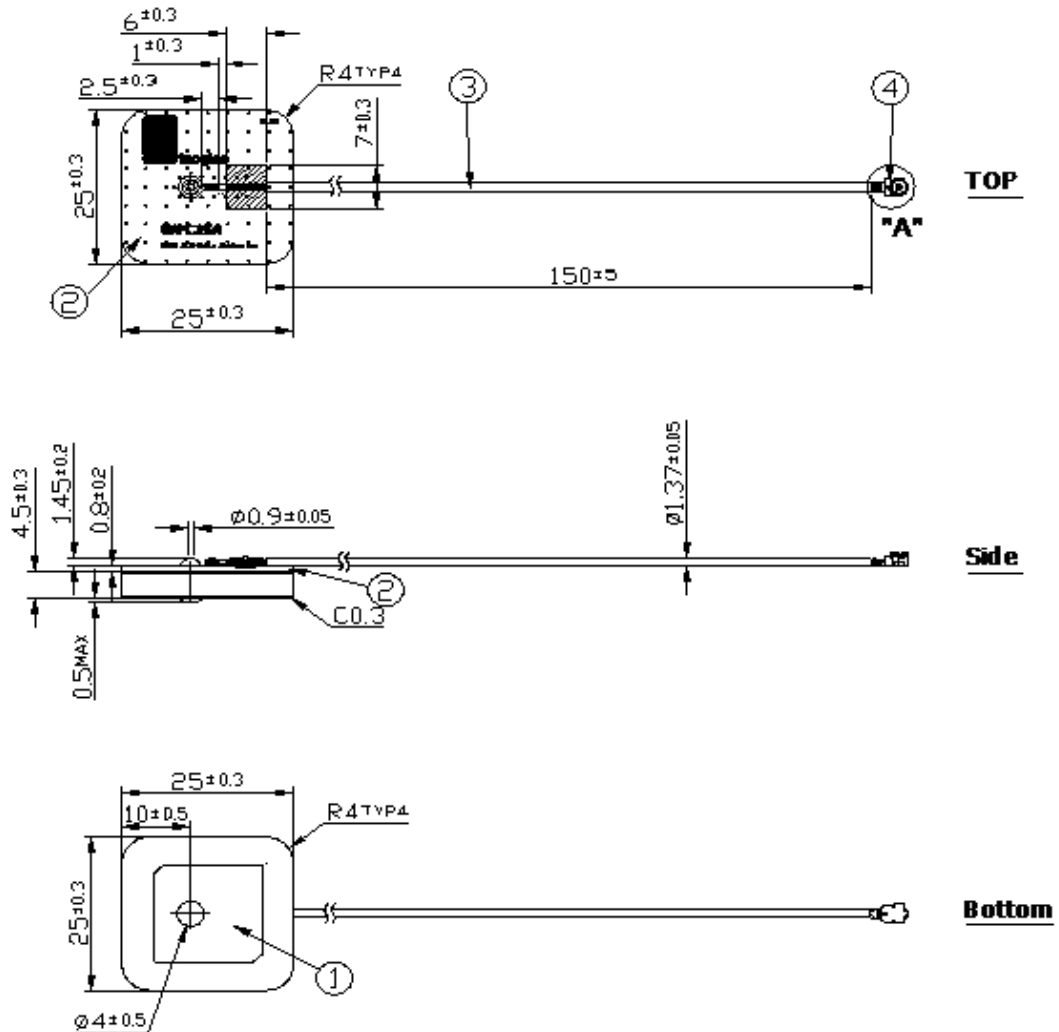

	Name	Material	Finish	QTY
1	WLP.2450 Patch 25x25x4	Ceramic	Clear	1
2	WPC.25A PCB	FR4 D.28	Black	1
3	1.37 Coaxial Cable	FEP	Black/Gray	1
4	IPEX MHF1	Brass	Gold	1

## VI Packaging

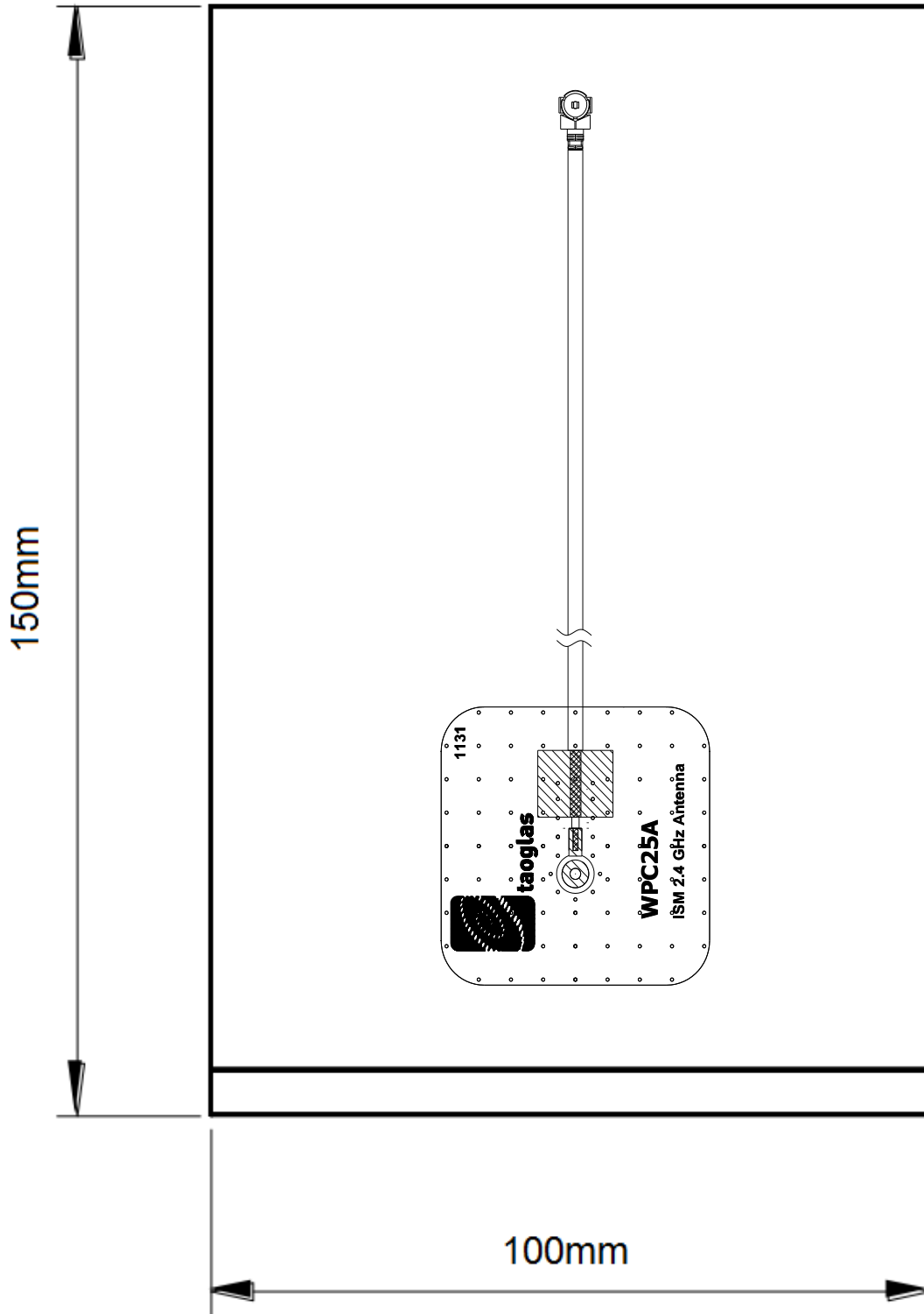

Each Antenna is packaged in a PE Bag 100mm\*150mm



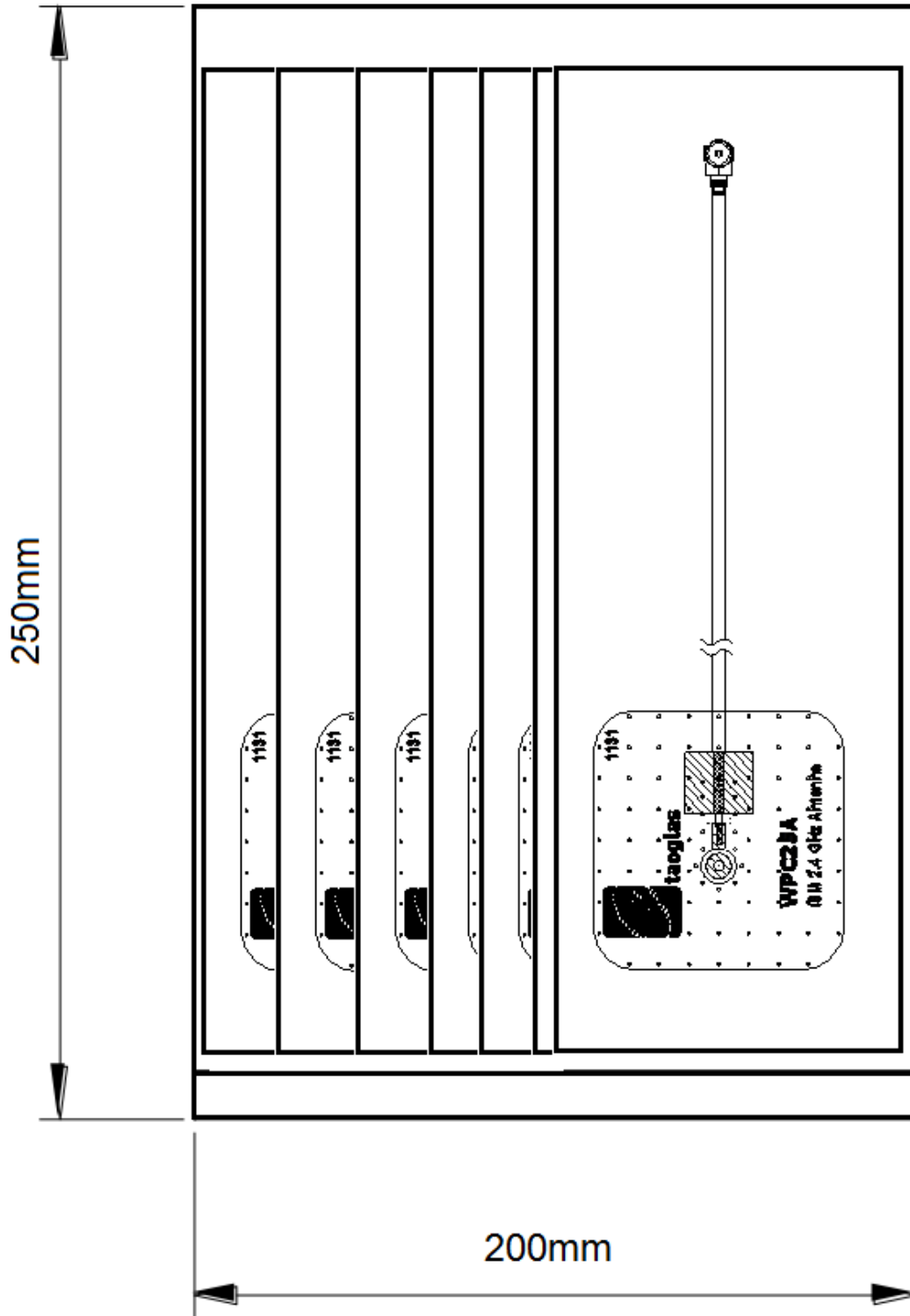

10 Antennas are then packaged in an Outer PE Bag: 250mm\*200mm

# Mouser Electronics

Authorized Distributor

Click to View Pricing, Inventory, Delivery & Lifecycle Information:

Taoglas:

[WPC.25A.07.0150C](#)