

Silicon NPN Transistors

- For AF driver and output stages
- High collector current
- High current gain
- Low collector-emitter saturation voltage
- Complementary types: BDP948, BDP950, BDP954 (PNP)
- Pb-free (RoHS compliant) package¹⁾
- Qualified according AEC Q101

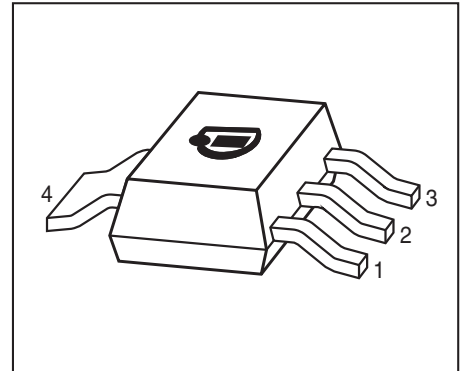

Type	Marking	Pin Configuration						Package
		1=B	2=C	3=E	4=C	-	-	
BDP947	BDP947	1=B	2=C	3=E	4=C	-	-	SOT223
BDP949	BDP949	1=B	2=C	3=E	4=C	-	-	SOT223
BDP953	BDP953	1=B	2=C	3=E	4=C	-	-	SOT223

Maximum Ratings

Parameter	Symbol	Value	Unit
Collector-emitter voltage	V_{CEO}		V
BDP947		45	
BDP949		60	
BDP953		100	
Collector-base voltage	V_{CBO}		
BDP947		45	
BDP949		60	
BDP953		120	
Emitter-base voltage	V_{EBO}	5	
Collector current	I_C	3	A
Peak collector current, $t_p \leq 10$ ms	I_{CM}	5	
Base current	I_B	200	mA
Peak base current, $t_p \leq 10$ ms	I_{BM}	500	
Total power dissipation- $T_S \leq 100$ °C	P_{tot}	5	W
Junction temperature	T_j	150	°C
Storage temperature	T_{stg}	-65 ... 150	

¹Pb-containing package may be available upon special request

Thermal Resistance

Parameter	Symbol	Value	Unit
Junction - soldering point ¹⁾	R_{thJS}	≤ 10	K/W

Electrical Characteristics at $T_A = 25^\circ\text{C}$, unless otherwise specified

Parameter	Symbol	Values			Unit
		min.	typ.	max.	
DC Characteristics					
Collector-emitter breakdown voltage $I_C = 10\text{ mA}$, $I_B = 0$, BDP947	$V_{(BR)CEO}$	45	-	-	V
$I_C = 10\text{ mA}$, $I_B = 0$, BDP949		60	-	-	
$I_C = 10\text{ mA}$, $I_B = 0$, BDP953		100	-	-	
Collector-base breakdown voltage $I_C = 100\text{ }\mu\text{A}$, $I_E = 0$, BDP947	$V_{(BR)CBO}$	45	-	-	
$I_C = 100\text{ }\mu\text{A}$, $I_E = 0$, BDP949		60	-	-	
$I_C = 0$, $I_E = 100\text{ }\mu\text{A}$, BDP953		120	-	-	
Emitter-base breakdown voltage $I_E = 10\text{ }\mu\text{A}$, $I_C = 0$	$V_{(BR)EBO}$	5	-	-	
Collector-base cutoff current $V_{CB} = 45\text{ V}$, $I_E = 0$ $V_{CB} = 45\text{ V}$, $I_E = 0$, $T_A = 150^\circ\text{C}$	I_{CBO}	-	-	0.1	μA
		-	-	20	
Emitter-base cutoff current $V_{EB} = 4\text{ V}$, $I_C = 0$	I_{EBO}	-	-	100	nA
DC current gain ²⁾ $I_C = 10\text{ mA}$, $V_{CE} = 5\text{ V}$ $I_C = 500\text{ mA}$, $V_{CE} = 1\text{ V}$ $I_C = 2\text{ A}$, $V_{CE} = 2\text{ V}$, BDP947, BDP949 $I_C = 2\text{ A}$, $V_{CE} = 2\text{ V}$, BDP953	h_{FE}	25	-	-	-
		100	-	475	
		50	-	-	
		15	-	-	
Collector-emitter saturation voltage ²⁾ $I_C = 2\text{ A}$, $I_B = 0.2\text{ A}$	V_{CEsat}	-	-	0.5	V
Base emitter saturation voltage ²⁾ $I_C = 2\text{ A}$, $I_B = 0.2\text{ A}$	V_{BEsat}	-	-	1.3	

AC Characteristics

Transition frequency $I_C = 50\text{ mA}$, $V_{CE} = 10\text{ V}$, $f = 100\text{ MHz}$	f_T	-	100	-	MHz
Collector-base capacitance $V_{CB} = 10\text{ V}$, $f = 1\text{ MHz}$	C_{cb}	-	25	-	pF

¹For calculation of R_{thJA} please refer to Application Note Thermal Resistance

²Pulse test: $t < 300\mu\text{s}$; $D < 2\%$

DC current gain $h_{FE} = f(I_C)$

$V_{CE} = 2\text{ V}$

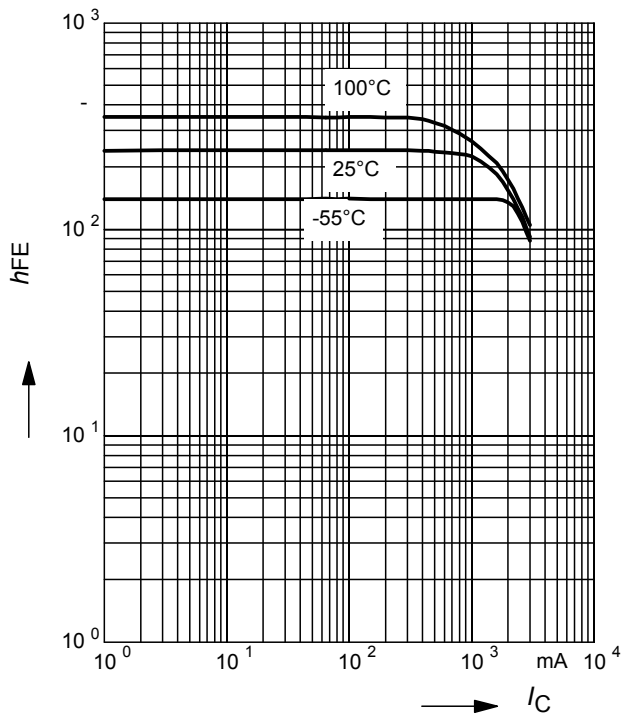

Collector-emitter saturation voltage

$I_C = f(V_{CEsat}), h_{FE} = 10$

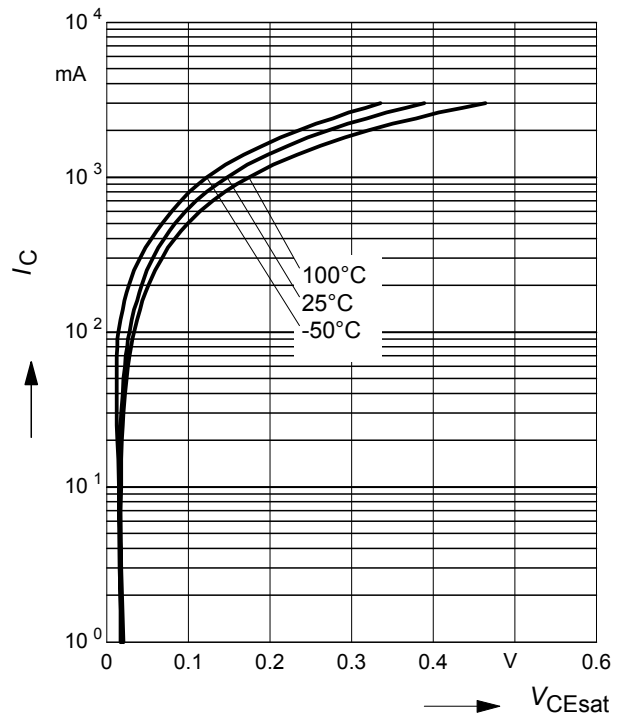

Base-emitter saturation voltage

$I_C = f(V_{BEsat}), h_{FE} = 10$

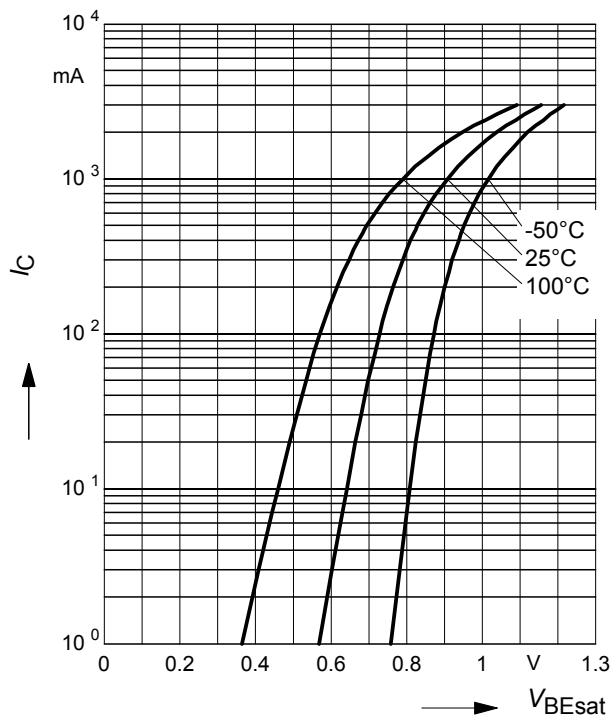

Collector current $I_C = f(V_{BE})$

$V_{CE} = 2\text{ V}$

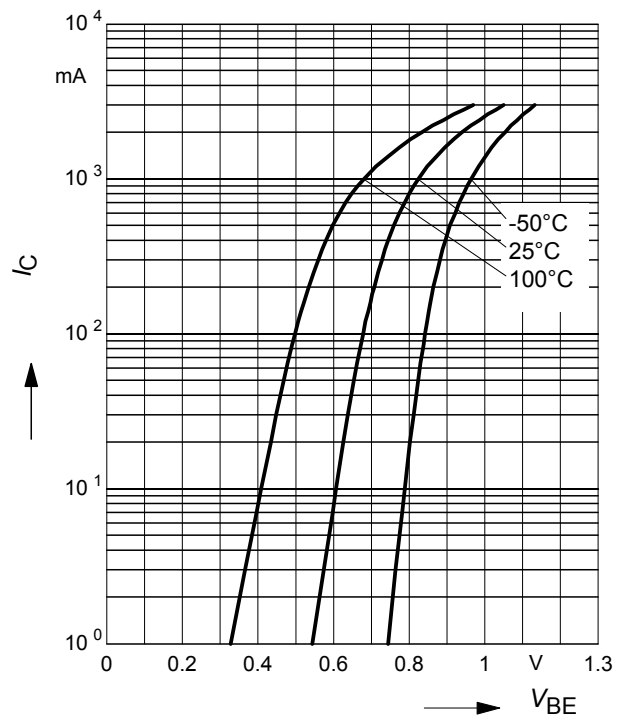

Collector cutoff current $I_{CBO} = f(T_A)$

$V_{CB} = 45\text{ V}$

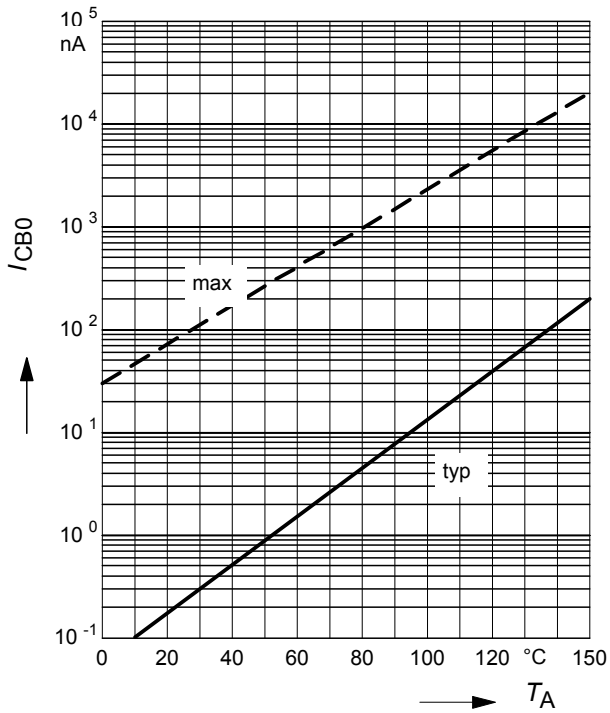

Collector-base capacitance $C_{cb} = f(V_{CB})$

Emitter-base capacitance $C_{eb} = f(V_{EB})$

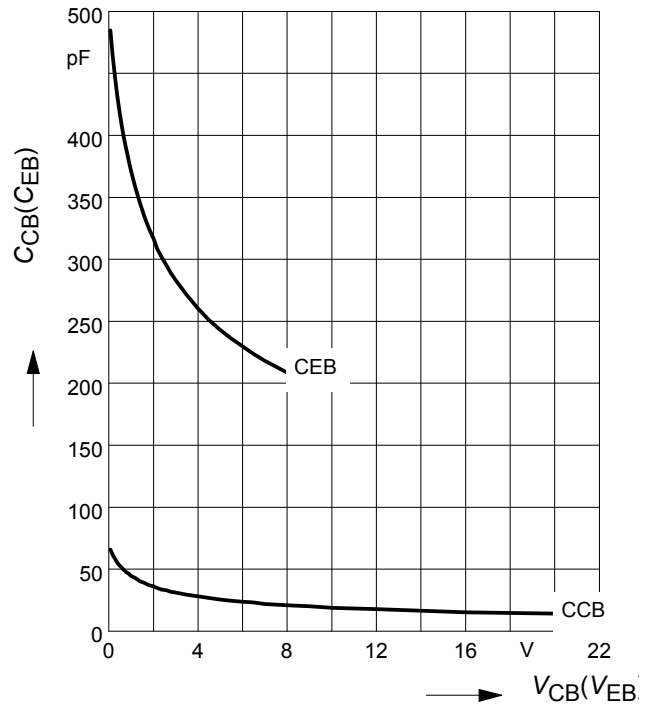

Total power dissipation $P_{tot} = f(T_S)$

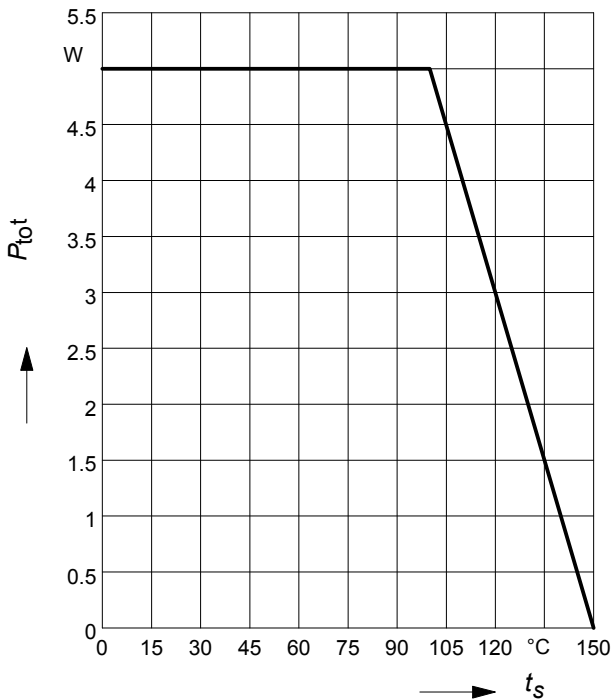

Permissible Pulse Load $R_{thJS} = f(t_p)$

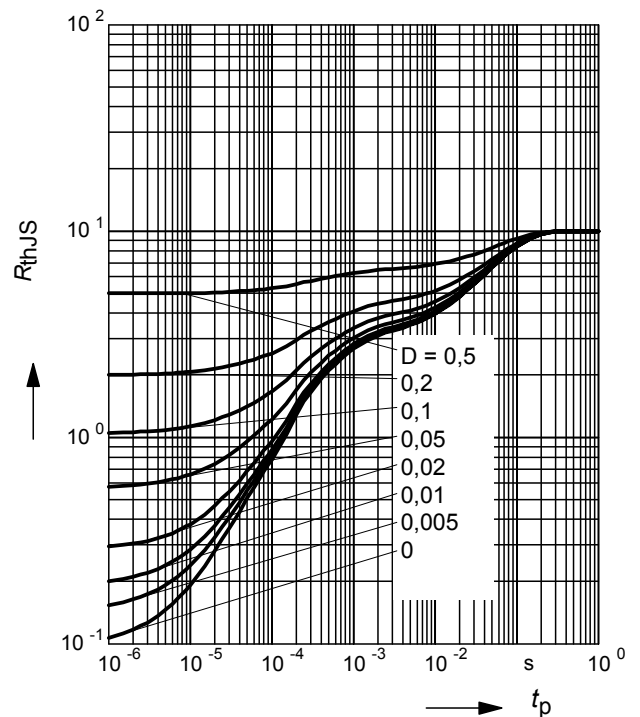

Permissible Pulse Load

$$P_{\text{totmax}}/P_{\text{totDC}} = f(t_p)$$

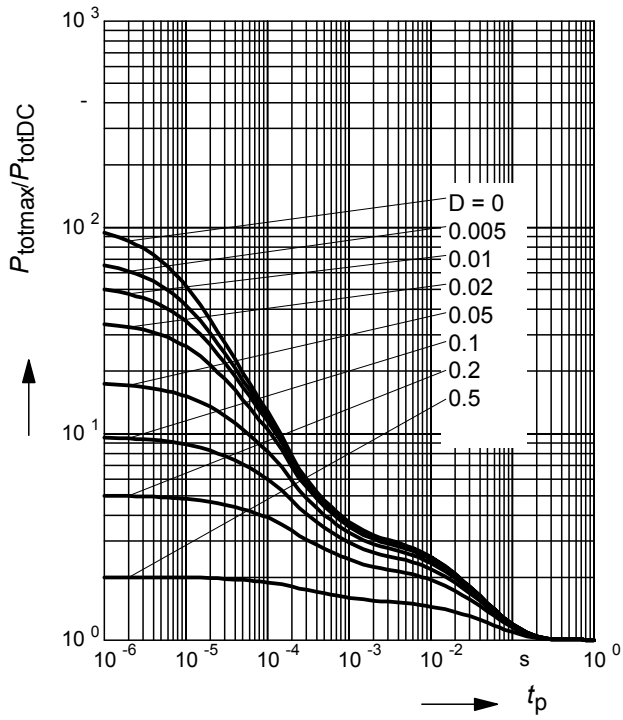

Package Outline

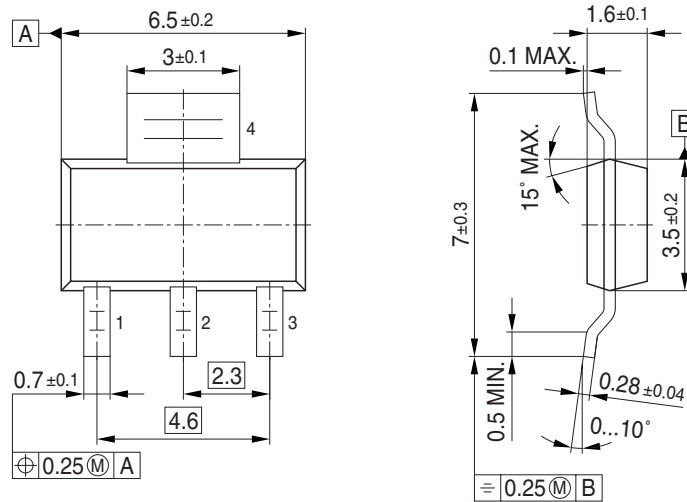

Foot Print

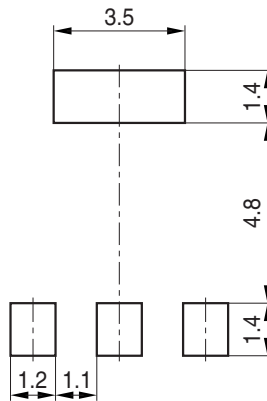

Marking Layout (Example)

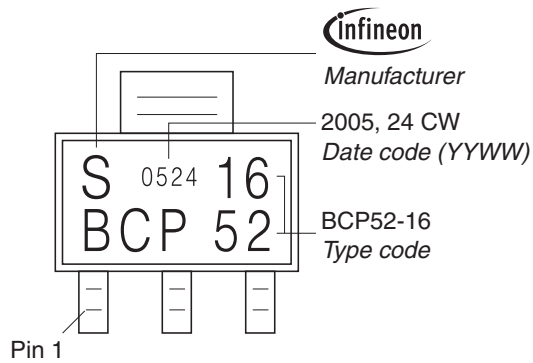

Packing

Reel $\varnothing 180 \text{ mm}$ = 1.000 Pieces/Reel
 Reel $\varnothing 330 \text{ mm}$ = 4.000 Pieces/Reel

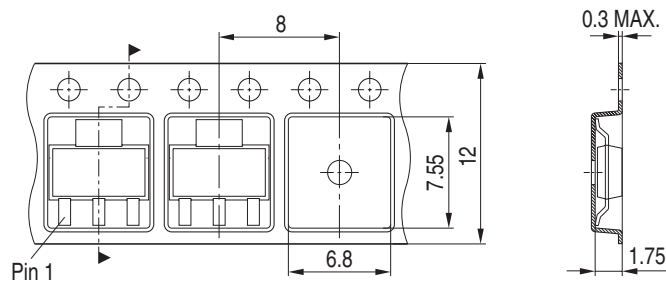

Edition 2006-02-01

Published by

Infineon Technologies AG

81726 München, Germany

© Infineon Technologies AG 2007.

All Rights Reserved.

Attention please!

The information given in this dokument shall in no event be regarded as a guarantee of conditions or characteristics ("Beschaffenheitsgarantie"). With respect to any examples or hints given herein, any typical values stated herein and/or any information regarding the application of the device, Infineon Technologies hereby disclaims any and all warranties and liabilities of any kind, including without limitation warranties of non-infringement of intellectual property rights of any third party.

Information

For further information on technology, delivery terms and conditions and prices please contact your nearest Infineon Technologies Office (www.infineon.com).

Warnings

Due to technical requirements components may contain dangerous substances. For information on the types in question please contact your nearest Infineon Technologies Office.

Infineon Technologies Components may only be used in life-support devices or systems with the express written approval of Infineon Technologies, if a failure of such components can reasonably be expected to cause the failure of that life-support device or system, or to affect the safety or effectiveness of that device or system.

Life support devices or systems are intended to be implanted in the human body, or to support and/or maintain and sustain and/or protect human life. If they fail, it is reasonable to assume that the health of the user or other persons may be endangered.