

# T-1 (3 mm) High Performance TS AlGaAs Red LED Lamps

## Technical Data

**HLMP-J100**  
**HLMP-J105**  
**HLMP-J150**  
**HLMP-J155**

### Features

- High Light Output over a Wide Range of Currents (500  $\mu$ A to 50 mA)
- Popular T-1 Package
- Low Forward Voltage
- Low Power Dissipation
- Deep Red Color
- Long Life: Solid State Reliability
- Wide Viewing Angles
- Available on Tape and Reel

### Applications

- Outdoor Message Boards
- Automotive Lighting
- Portable Equipment
- Safety Lighting Equipment
- Medical Equipment
- Changeable Message Signs

### Package Dimensions

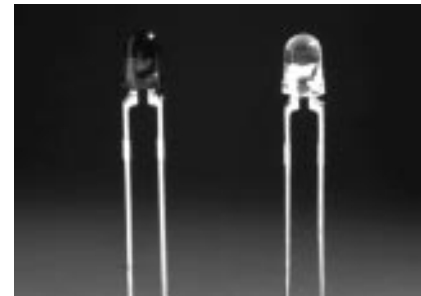
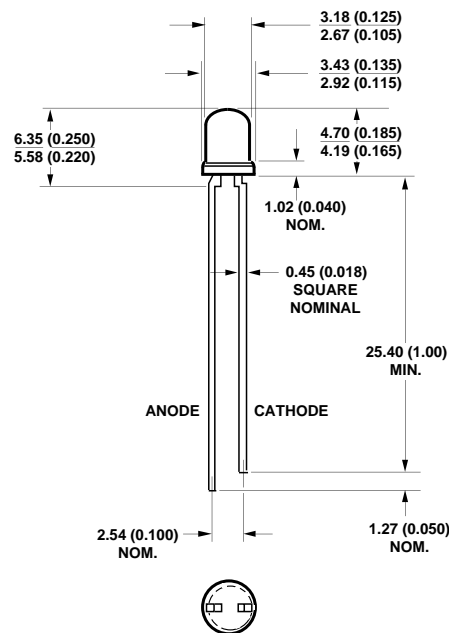

### Description

The T-1 solid state lamps utilize a highly optimized LED material technology, transparent substrate aluminum gallium arsenide (TS AlGaAs). This LED technology has a very high luminous efficiency, capable of producing high light output over a wide range of drive currents (500  $\mu$ A to 50 mA). The color is deep red at a dominant wavelength of 644 nm. TS AlGaAs is a flip-chip LED technology, die attached to the anode lead and wire bonded to the cathode lead.

### Device Selection Guide

Package Description	Viewing Angle $2\theta^{1/2}$	Deep Red $\lambda_d = 644 \text{ nm}$	Typical $I_V$ (mcd) $I_F = 20 \text{ mA}$	Typical $I_V$ (mcd) $I_F = 0.5 \text{ mA}$
T-1 (3 mm), Untinted, Non-diffused, Standard Current	45°	HLMP-J105	340	–
T-1 (3 mm), Untinted, Non-diffused, Low Current	45°	HLMP-J155	–	6
T-1 (3 mm), Tinted, Diffused, Standard Current	55°	HLMP-J100	175	–
T-1, (3 mm), Tinted, Diffused, Low Current	55°	HLMP-J150	–	3

## Absolute Maximum Ratings

Peak Forward Current <sup>[2]</sup> .....	300 mA
Average Forward Current (@ I <sub>PEAK</sub> = 300 mA) <sup>[1,2]</sup> .....	30 mA
DC Forward Current <sup>[3]</sup> .....	50 mA
Power Dissipation .....	100 mW
Reverse Voltage (I <sub>R</sub> = 100 μA) .....	5 V
Transient Forward Current (10 μs Pulse) <sup>[4]</sup> .....	500 mA
Operating Temperature Range .....	-55 to +100°C
Storage Temperature Range .....	-55 to +100°C
LED Junction Temperature .....	110°C
Solder Temperature .....	260°C for 5 seconds

[1.6 mm (0.063 in.) from body]

### Notes:

1. Maximum I<sub>AVG</sub> at f = 1 kHz, DF = 10%.
2. Refer to Figure 6 to establish pulsed operating conditions.
3. Derate linearly as shown in Figure 5.
4. The transient peak current is the maximum non-recurring peak current the device can withstand without damaging the LED die and wire bonds. It is not recommended that the device be operated at peak currents above the Absolute Maximum Peak Forward Current.

## Optical Characteristics at T<sub>A</sub> = 25°C

Part Number	Luminous Intensity I <sub>v</sub> (mcd) @ 20 mA <sup>[1]</sup>		Total Flux φ <sub>v</sub> (lm) @ 20 mA <sup>[2]</sup>	Peak Wavelength λ <sub>PEAK</sub> (nm) Typ.	Color, Dominant Wavelength λ <sub>d</sub> <sup>[3]</sup> (nm) Typ.	Viewing Angle 2θ <sup>1/2</sup> (Degrees) <sup>[4]</sup> Typ.	Luminous Efficacy η <sub>v</sub> (lm/w)
	Min.	Typ.					
HLMP-J105	56.4	340	280	654	644	45	85
HLMP-J100	35.2	175		654	644	55	85

## Optical Characteristics at T<sub>A</sub> = 25°C

Part Number (Low Current)	Luminous Intensity I <sub>v</sub> (mcd) @ 0.5 mA <sup>[1]</sup>		Total Flux φ <sub>v</sub> (lm) @ 0.5 mA <sup>[2]</sup>	Peak Wavelength λ <sub>PEAK</sub> (nm) Typ.	Color, ZDominant Wavelength λ <sub>d</sub> <sup>[3]</sup> (nm) Typ.	Viewing Angle 2θ <sup>1/2</sup> (Degrees) <sup>[4]</sup> Typ.	Luminous Efficacy η <sub>v</sub> (lm/w)
	Min.	Typ.					
HLMP-J155	2.1	6.0	37.2	654	644	45	85
HLMP-J150	1.3	3.0		654	644	55	85

### Notes:

1. The luminous intensity, I<sub>v</sub>, is measured at the mechanical axis of the lamp package. The actual peak of the spatial radiation pattern may not be aligned with this axis.
2. φ<sub>v</sub> is total luminous flux output as measured with an integrating sphere.
3. The dominant wavelength, λ<sub>d</sub>, is derived from the CIE Chromaticity Diagram and represents the color of the device.
4. θ<sup>1/2</sup> is the off-axis angle where the luminous intensity is 1/2 the peak intensity.

### Electrical Characteristics at $T_A = 25^\circ\text{C}$

Part Number	Forward Voltage $V_F$ (Volts) @ $I_F = 20\text{ mA}$		Reverse Breakdown $V_R$ (Volts) @ $I_R = 100\ \mu\text{A}$		Capacitance $C$ (pF) $V_F = 0$ , $f = 1\text{ MHz}$ Typ.	Thermal Resistance $R\theta_{J-PIN}$ ( $^\circ\text{C}/\text{W}$ )	Speed of Response $\tau_s$ (ns) Time Constant $e^{-t/\tau_s}$ Typ.
	Typ.	Max.	Min.	Typ.			
HLMP-J105	1.9	2.4	5	20	20	290	45
HLMP-J100	1.9	2.4	5	20	20	290	45

### Electrical Characteristics at $T_A = 25^\circ\text{C}$

Part Number (Low Current)	Forward Voltage $V_F$ (Volts) @ $I_F = 0.5\text{ mA}$		Reverse Breakdown $V_R$ (Volts) @ $I_R = 100\ \mu\text{A}$		Capacitance $C$ (pF) $V_F = 0$ , $f = 1\text{ MHz}$ Typ.	Thermal Resistance $R\theta_{J-PIN}$ ( $^\circ\text{C}/\text{W}$ )	Speed of Response $\tau_s$ (ns) Time Constant $e^{-t/\tau_s}$ Typ.
	Typ.	Max.	Min.	Typ.			
HLMP-J155	1.6	1.9	5	20	20	290	45
HLMP-J150	1.6	1.9	5	20	20	290	45

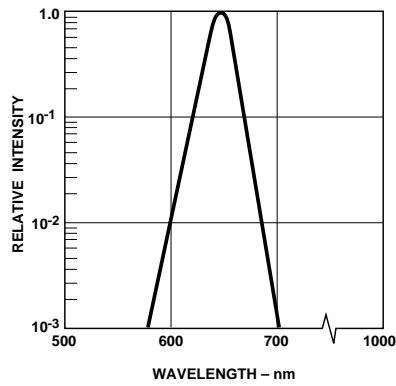

Figure 1. Relative Intensity vs. Wavelength.

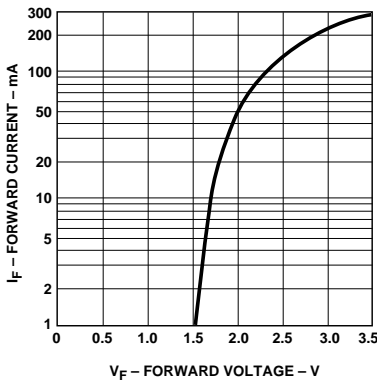

Figure 2. Forward Current vs. Forward Voltage.

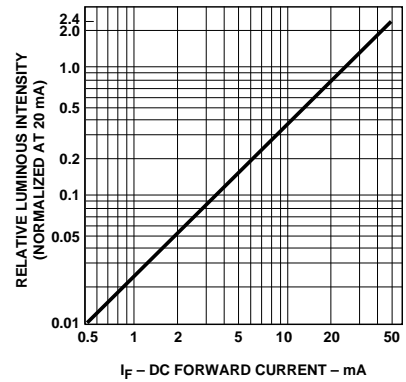

Figure 3. Relative Luminous Intensity vs. DC Forward Current.

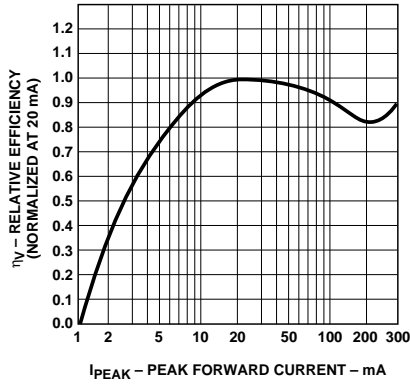

Figure 4. Relative Efficiency vs. Peak Forward Current.

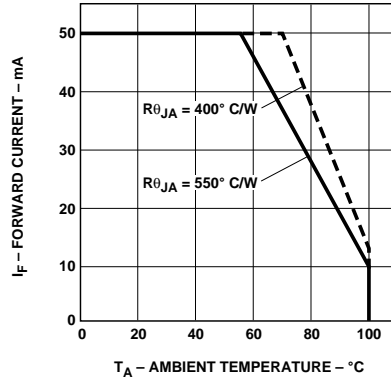

Figure 5. Maximum Forward DC Current vs. Ambient Temperature. Derating Based on  $T_{JMAX} = 110\text{ }^{\circ}\text{C}$ .

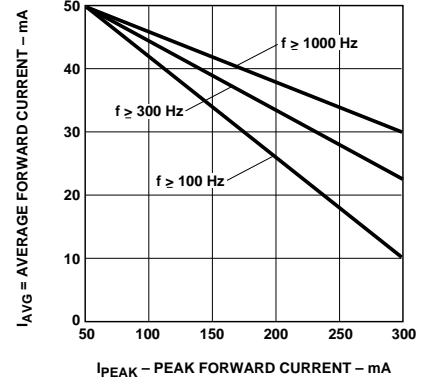

Figure 6. Maximum Average Current vs. Peak Forward Current.

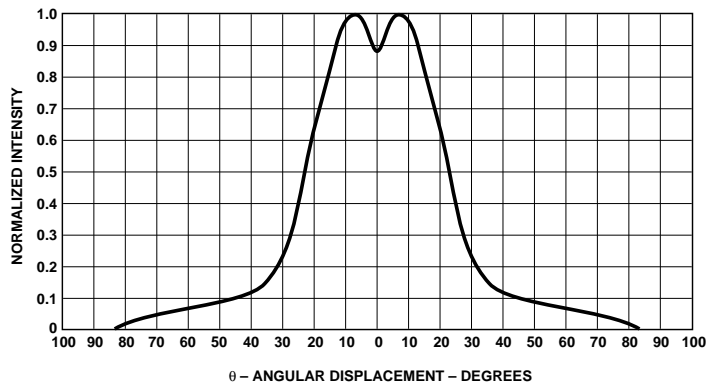

Figure 7. Normalized Luminous Intensity vs. Angular Displacement. HLMP-J105/J155.

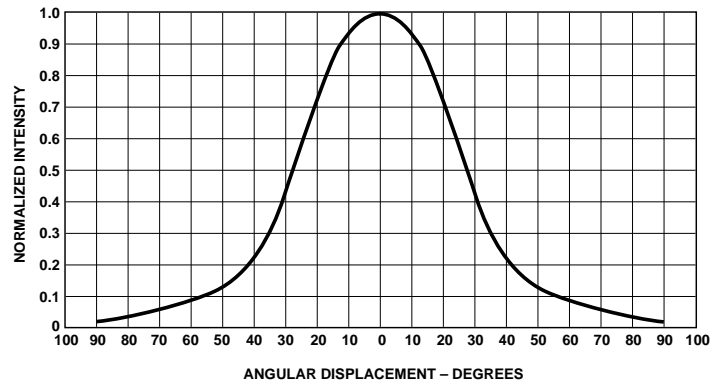

Figure 8. Normalized Luminous Intensity vs. Angular Displacement. HLMP-J100/J150.

This datasheet has been download from:

[www.datasheetcatalog.com](http://www.datasheetcatalog.com)

Datasheets for electronics components.