

**Smallest sealed snap-action switch in the industry with a very long stroke for reliable ON/OFF action.**

- The case dimensions are 78% of conventional models, contributing to down-sizing of mechanical modules.
- Extra-long stroke even without levers. (OT: 1.4 mm)
- Made of environment-friendly materials. All models are lead-free, including molded lead wire models.

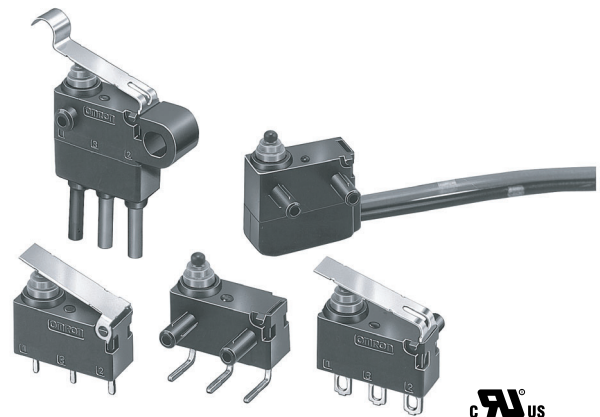

## Ordering Information

### ■ Model Number Legend:

D2HW-

--	--	--	--	--

  
1 2 3 4 5

#### 1. Mounting Structure

- A: Without posts (base-mounting)
- BR: Posts on right
- BL: Posts on left
- C: M3-screw mounting

#### 2. Ratings

- 2: 1 mA at 5 VDC to 2 A at 12 VDC

#### 3. Actuator

- 0: Pin plunger
- 1: Hinge lever
- 2: Long hinge lever
- 3: Simulated roller hinge lever
- 4: Hinge roller lever
- 6: Leaf lever
- 7: Simulated roller leaf lever
- 8: Long leaf lever

#### 4. Contacts

- 1: SPDT
- 2: SPST-NC (Molded lead wire models only.)
- 3: SPST-NO (Molded lead wire models only.)







#### 5. Terminals

- D: Straight PCB terminals
- DR: Right-angled PCB terminals
- DL: Left-angled PCB terminals
- H: Solder terminals
- M: Molded lead wires downwards
- MR: Molded lead wires on right-side
- ML: Molded lead wires on left-side

**Note** Add "S" to the end of the model number for the UL/CSA-approved version.







## ■ List of Models

### PCB-mounted Models









Actuator	Terminals		Contact form	Model		
				With posts on right 	With posts on left 	Without posts 
Pin plunger 	For PCB	Straight	SPDT	---	---	D2HW-A201D
		Angled		D2HW-BR201DR	D2HW-BL201DL	---
Hinge lever 		Straight		---	---	D2HW-A211D
		Angled		D2HW-BR211DR	D2HW-BL211DL	---
Long hinge lever 		Straight		---	---	D2HW-A221D
		Angled		D2HW-BR221DR	D2HW-BL221DL	---
Simulated roller hinge lever 		Straight		---	---	D2HW-A231D
		Angled		D2HW-BR231DR	D2HW-BL231DL	---

**Note** Add "S" to the end of the model number for the UL/CSA-approved version. Consult your OMRON sales representative for details.

### Models with Solder Terminals or Molded Lead Wires

Actuator	Terminals		Contact form	Model		
				With posts on right 	With posts on left 	M3-screw mounting 
Pin plunger 	Solder		SPDT	D2HW-BR201H	D2HW-BL201H	D2HW-C201H
	Molded lead wires	Downwards	SPDT	D2HW-BR201M	D2HW-BL201M	D2HW-C201M
			SPST-NC	D2HW-BR202M	D2HW-BL202M	D2HW-C202M
			SPST-NO	D2HW-BR203M	D2HW-BL203M	D2HW-C203M
		Right-side	SPST-NC	D2HW-BR202MR	D2HW-BL202MR	D2HW-C202MR
			SPST-NO	D2HW-BR203MR	D2HW-BL203MR	D2HW-C203MR
		Left-side	SPST-NC	D2HW-BR202ML	D2HW-BL202ML	---
	SPST-NO		D2HW-BR203ML	D2HW-BL203ML	---	
Hinge lever 	Solder		SPDT	D2HW-BR211H	D2HW-BL211H	D2HW-C211H
	Molded lead wires	Downwards	SPDT	D2HW-BR211M	D2HW-BL211M	D2HW-C211M
			SPST-NC	D2HW-BR212M	D2HW-BL212M	D2HW-C212M
			SPST-NO	D2HW-BR213M	D2HW-BL213M	D2HW-C213M
		Right-side	SPST-NC	D2HW-BR212MR	D2HW-BL212MR	D2HW-C212MR
			SPST-NO	D2HW-BR213MR	D2HW-BL213MR	D2HW-C213MR
		Left-side	SPST-NC	D2HW-BR212ML	D2HW-BL212ML	---
	SPST-NO		D2HW-BR213ML	D2HW-BL213ML	---	
Long hinge lever 	Solder		SPDT	D2HW-BR221H	D2HW-BL221H	D2HW-C221H
	Molded lead wires	Downwards	SPDT	D2HW-BR221M	D2HW-BL221M	D2HW-C221M
			SPST-NC	D2HW-BR222M	D2HW-BL222M	D2HW-C222M
			SPST-NO	D2HW-BR223M	D2HW-BL223M	D2HW-C223M
		Right-side	SPST-NC	D2HW-BR222MR	D2HW-BL222MR	D2HW-C222MR
			SPST-NO	D2HW-BR223MR	D2HW-BL223MR	D2HW-C223MR
		Left-side	SPST-NC	D2HW-BR222ML	D2HW-BL222ML	---
	SPST-NO		D2HW-BR223ML	D2HW-BL223ML	---	

- Note:**
1. The length of standard lead wires (AVSS0.5) for molded lead wire models is 30 cm.
  2. Add "S" to the end of the model number for the UL/CSA-approved version. Consult your OMRON sales representative for details.

Actuator	Terminals		Contact form	Model		
				With posts on right 	With posts on left 	M3-screw mounting 
<b>Simulated roller hinge lever</b> 	Solder		SPDT	D2HW-BR231H	D2HW-BL231H	D2HW-C231H
	Molded lead wires	Downwards	SPDT	D2HW-BR231M	D2HW-BL231M	D2HW-C231M
			SPST-NC	D2HW-BR232M	D2HW-BL232M	D2HW-C232M
			SPST-NO	D2HW-BR233M	D2HW-BL233M	D2HW-C233M
			SPST-NC	D2HW-BR232MR	D2HW-BL232MR	D2HW-C232MR
		Right-side	SPST-NO	D2HW-BR233MR	D2HW-BL233MR	D2HW-C233MR
			SPST-NC	D2HW-BR232ML	D2HW-BL232ML	---
	Left-side	SPST-NO	D2HW-BR233ML	D2HW-BL233ML	---	
SPST-NC		D2HW-BR232ML	D2HW-BL232ML	---		
<b>Hinge roller lever</b> 	Solder		SPDT	D2HW-BR241H	D2HW-BL241H	D2HW-C241H
	Molded lead wires	Downwards	SPDT	D2HW-BR241M	D2HW-BL241M	D2HW-C241M
			SPST-NC	D2HW-BR242M	D2HW-BL242M	D2HW-C242M
			SPST-NO	D2HW-BR243M	D2HW-BL243M	D2HW-C243M
			SPST-NC	D2HW-BR242MR	D2HW-BL242MR	D2HW-C242MR
		Right-side	SPST-NO	D2HW-BR243MR	D2HW-BL243MR	D2HW-C243MR
			SPST-NC	D2HW-BR242ML	D2HW-BL242ML	---
	Left-side	SPST-NO	D2HW-BR243ML	D2HW-BL243ML	---	
SPST-NC		D2HW-BR242ML	D2HW-BL242ML	---		
<b>Leaf lever</b> 	Solder		SPDT	D2HW-BR261H	D2HW-BL261H	D2HW-C261H
	Molded lead wires	Downwards	SPDT	D2HW-BR261M	D2HW-BL261M	D2HW-C261M
			SPST-NC	D2HW-BR262M	D2HW-BL262M	D2HW-C262M
			SPST-NO	D2HW-BR263M	D2HW-BL263M	D2HW-C263M
			SPST-NC	D2HW-BR262MR	D2HW-BL262MR	D2HW-C262MR
		Right-side	SPST-NO	D2HW-BR263MR	D2HW-BL263MR	D2HW-C263MR
			SPST-NC	D2HW-BR262ML	D2HW-BL262ML	---
	Left-side	SPST-NO	D2HW-BR263ML	D2HW-BL263ML	---	
SPST-NC		D2HW-BR262ML	D2HW-BL262ML	---		
<b>Simulated roller leaf lever</b> 	Solder		SPDT	D2HW-BR271H	D2HW-BL271H	D2HW-C271H
	Molded lead wires	Downwards	SPDT	D2HW-BR271M	D2HW-BL271M	D2HW-C271M
			SPST-NC	D2HW-BR272M	D2HW-BL272M	D2HW-C272M
			SPST-NO	D2HW-BR273M	D2HW-BL273M	D2HW-C273M
			SPST-NC	D2HW-BR272MR	D2HW-BL272MR	D2HW-C272MR
		Right-side	SPST-NO	D2HW-BR273MR	D2HW-BL273MR	D2HW-C273MR
			SPST-NC	D2HW-BR272ML	D2HW-BL272ML	---
	Left-side	SPST-NO	D2HW-BR273ML	D2HW-BL273ML	---	
SPST-NC		D2HW-BR272ML	D2HW-BL272ML	---		
<b>Long leaf lever</b> 	Molded lead wires	Downwards	SPDT	D2HW-BR281M	D2HW-BL281M	D2HW-C281M
			SPST-NC	D2HW-BR282M	D2HW-BL282M	D2HW-C282M
			SPST-NO	D2HW-BR283M	D2HW-BL283M	D2HW-C283M
			SPST-NC	---	---	D2HW-C282MR
		Right-side	SPST-NO	---	---	D2HW-C283MR
			SPST-NC	---	---	D2HW-C283MR

**Note:** 1. The length of standard lead wires (AVSS 0.5) for molded lead wire models is 30 cm.

2. Add "S" to the end of the model number for the UL/CSA-approved version. Consult your OMRON sales representative for details.

## Specifications

### ■ Ratings

Rated voltage (V)	Resistive load
125 VAC	0.1 A
12 VDC	2 A
24 VDC	1 A
42 VDC	0.5 A

**Note** The ratings values apply under the following test conditions:

Ambient temperature: 20±2°C  
 Ambient humidity: 65±5%  
 Operating frequency: 30 operations/min

## ■ Characteristics

Item	Specification
Operating speed	1 mm to 500 mm/s (for pin plunger models)
Operating frequency	30 operations/min max.
Insulation resistance	100 MΩ min. (at 500 VDC)
Contact resistance (initial value)	100 mΩ max. (molded lead wire models: 150 mΩ max.)
Dielectric strength	600 VAC, 50/60 Hz for 1 min between terminals of the same polarity 1,500 VAC, 50/60 Hz for 1 min between current-carrying metal parts and ground, and between each terminal and non-current-carrying metal parts
Vibration resistance (see note 2)	Malfunction: 10 to 55 Hz, 1.5-mm double amplitude
Shock resistance (see note 2)	Destruction: 1,000 m/s <sup>2</sup> {approx. 100 G} max. Malfunction: 300 m/s <sup>2</sup> {approx. 30 G} max.
Durability (see note 3)	Mechanical: 1,000,000 operations min. (30 operations/min) Electrical: 100,000 operations min. (20 operations/min)
Degree of protection	IEC IP67 (excluding the terminals on terminal models)
Degree of protection against electric shock	Class I
Proof tracking index (PTI)	175
Ambient operating temperature	-40 to 85°C (with no icing)
Ambient operating humidity	95% max. (for 5 to 35°C)
Weight	Approx. 0.7 g (for pin plunger models with terminals)

- Note:**
- The data given above are initial values.
  - For the pin plunger models, the above values apply for use at the free position, operating position, and total travel position. For the lever models, they apply at the total travel position.  
The values shown apply for malfunctions of 1 ms max.
  - For testing conditions, consult your OMRON sales representative.

## ■ Approved Standards

Consult your OMRON sales representative for specific models with standard approvals.

**UL1054 (File No. E41515)/CSA C22.2 No. 55 (UL approval)**

Rated voltage	D2HW
125 VAC	0.1 A
12 VDC	2 A

## ■ Contact Specifications

Item	Specification
Specification	Crossbar
Material	Gold alloy
Gap (standard value)	0.5 mm
Minimum applicable load (see note)	1 mA at 5 VDC

- Note** Minimum applicable loads are indicated by N standard reference values. This value represents the failure rate at a 60% ( $\lambda_{60}$ ) reliability level.  
The equation  $\lambda_{60}=0.35 \times 10^{-6}/\text{operations}$  indicates that a failure rate of 1/2,000,000 operations can be expected at a reliability level of 60%.

## ■ Contact Form

### SPDT

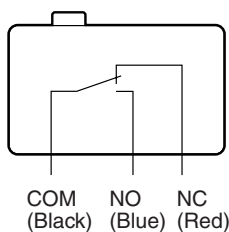

### SPST-NC (Molded Lead Wire Models Only)

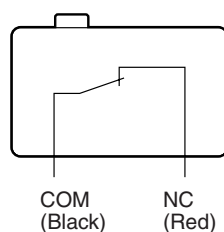

### SPST-NO (Molded Lead Wire Models Only)

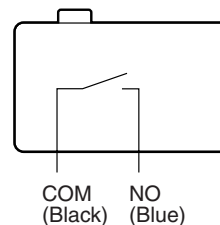

- Note** Molded lead wire colors are indicated in parentheses.

# Dimensions

## ■ Mounting Structure and Reference Positions for Operating Characteristics

**Note** All units are in millimeters unless otherwise indicated.

The reference positions used for FP, OP, and TTP values are as shown below for each type of mounting.

### Models without Posts D2HW-A□

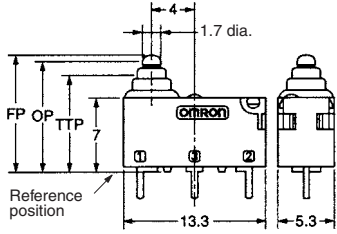

### Models with Posts D2HW-B□

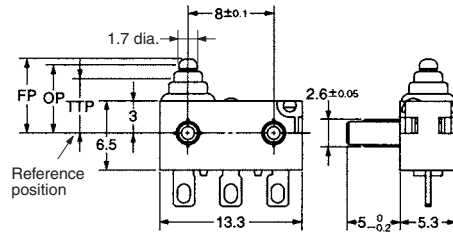

### M3-screw Mounting Models D2HW-C□

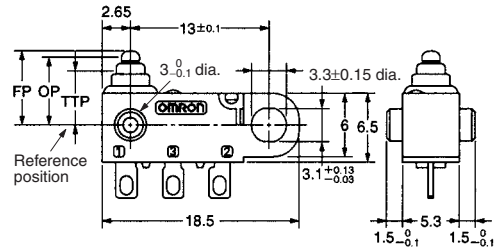

### Mounting Hole Dimensions (Reference)

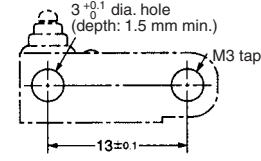
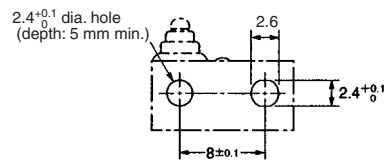

## ■ Terminals

### Straight PCB Terminals

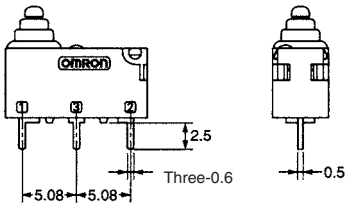

### PCB Cutout Dimensions (Reference)

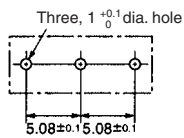

### Angled PCB Terminals

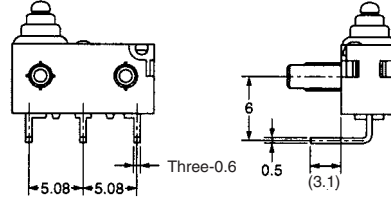

### PCB Cutout Dimensions (Reference)

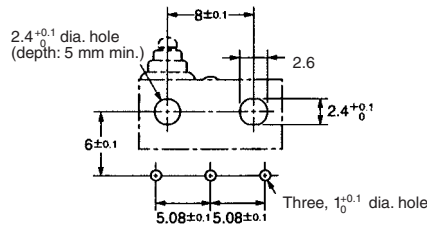

### Solder Terminals

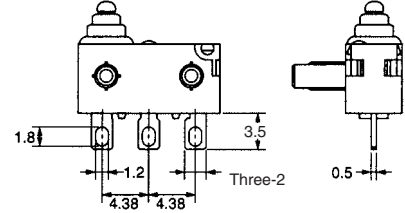

### Molded Lead Wires Downwards

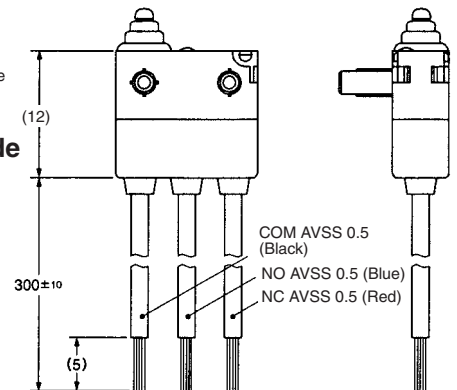

### Molded Lead Wires on Left-side

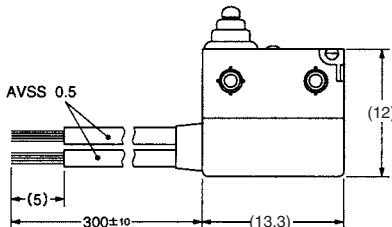

### Molded Lead Wires on Right-side

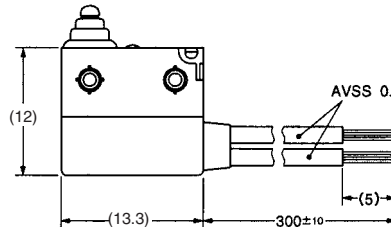

### ■ Dimensions and Operating Characteristics

- Note:**
1. All units are in millimeters unless otherwise indicated.
  2. Dimensions not indicated in the above diagrams have a tolerance of  $\pm 0.2$  mm.
  3. The operating characteristics are for operation in the A direction (  $\downarrow$  ).

#### Pin Plunger Models

D2HW-□20□□

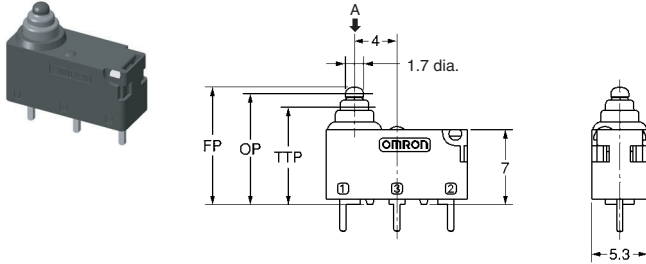

Characteristic	Models without posts	Models with posts and M3-mounting models
OF max.	0.75 N {76 gf}	
RF min.	0.10 N {10 gf}	
OT ref.	1.4 mm (reference value)	
MD max.	0.25 mm	
FP max.	11.2 mm	7.2 mm
OP	10.4±0.2 mm	6.4±0.2 mm
TTP max.	9.1 mm	5.1 mm

#### Hinge Lever Models

D2HW-□21□□

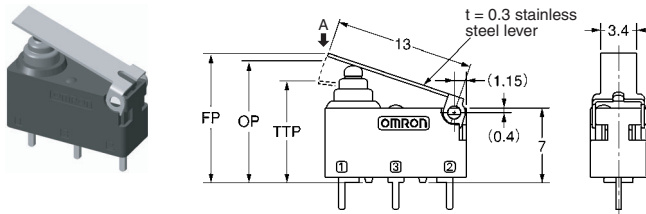

Characteristic	Models without posts	Models with posts and M3-mounting models
OF max.	0.75 N {76 gf}	
RF min.	0.07 N {7 gf}	
OT ref.	1.6 mm (reference value)	
MD max.	0.5 mm	
FP max.	12.8 mm	8.8 mm
OP	11.5±0.5 mm	7.5±0.5 mm
TTP max.	10 mm	6 mm

#### Long Hinge Lever Models

D2HW-□22□□

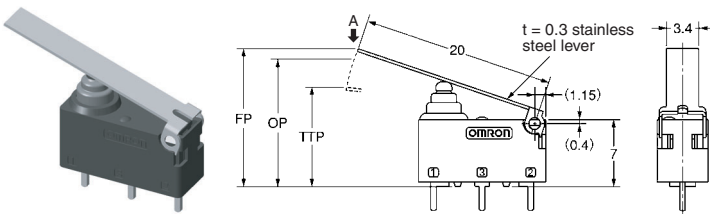

Characteristic	Models without posts	Models with posts and M3-mounting models
OF max.	0.5 N {50 gf}	
RF min.	0.03 N {3 gf}	
OT ref.	2.5 mm (reference value)	
MD max.	0.8 mm	
FP max.	15.5 mm	11.5 mm
OP	13.3±0.8 mm	9.3±0.8 mm
TTP max.	11 mm	7 mm

#### Simulated Roller Hinge Lever Models

D2HW-□23□□

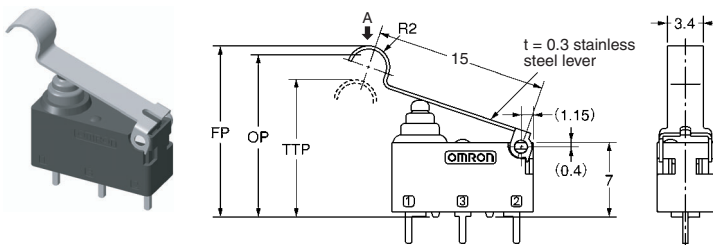

Characteristic	Models without posts	Models with posts and M3-mounting models
OF max.	0.65 N {66 gf}	
RF min.	0.05 N {5 gf}	
OT ref.	1.9 mm (reference value)	
MD max.	0.5 mm	
FP max.	16.5 mm	12.5 mm
OP	15.2±0.5 mm	11.2±0.5 mm
TTP max.	13.5 mm	9.5 mm

### Hinge Roller Lever Models

D2HW-□24□□

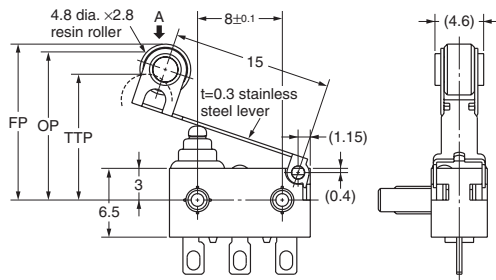
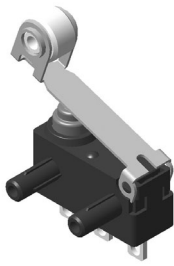

Characteristic	Models with posts and M3-mounting models
OF max.	0.65 N {66 gf}
RF min.	0.03 N {3 gf}
OT ref.	1.9 mm (reference value)
MD max.	0.6 mm
FP max.	15.3 mm
OP	14±0.6 mm
TTP max.	12.3 mm

### Leaf Lever Models

D2HW-□26□□

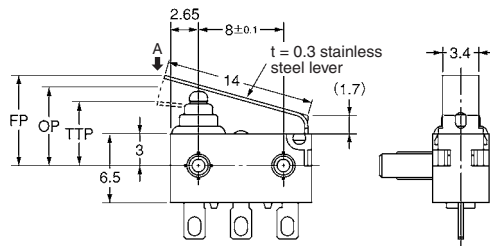
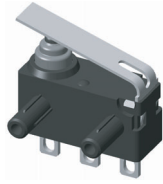

Characteristic	Models with posts and M3-mounting models
OF max.	1.8 N {183 gf}
RF min.	0.20 N {20 gf}
OT ref.	1.8 mm (reference value)
MD max.	0.5 mm
FP max.	9.3 mm
OP	7.4±0.5 mm
TTP max.	5.8 mm

### Simulated Roller Leaf Lever Models

D2HW-□27□□

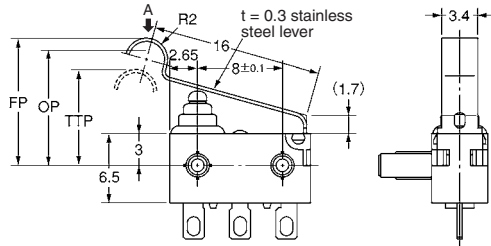

Characteristic	Models with posts and M3-mounting models
OF max.	1.8 N {183 gf}
RF min.	0.20 N {20 gf}
OT ref.	2.0 mm (reference value)
MD max.	0.5 mm
FP max.	12.5 mm
OP	10.8±0.5 mm
TTP max.	8.9 mm

### Long Leaf Lever Models

D2HW-□28□□

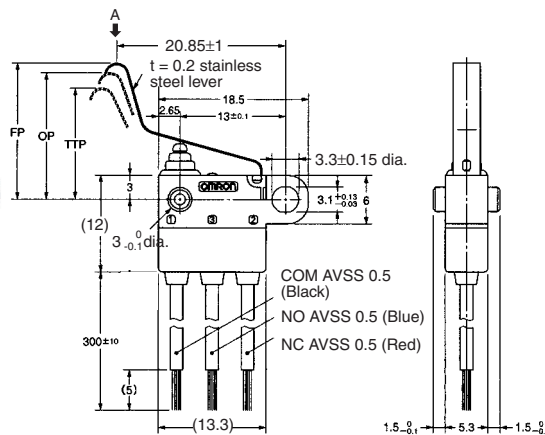
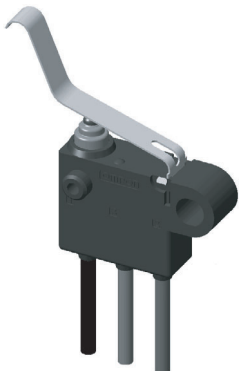

Characteristic	Models with posts and M3-mounting models
OF max.	0.9 N {92 gf}
RF min.	0.05 N {5 gf}
OT ref.	2.8 mm (reference value)
MD max.	0.7 mm
FP max.	19 mm
OP	15.4±1.5 mm
TTP max.	12.8 mm

# Precautions

## ■ Cautions

### Degree of Protection

Do not use this product in water. Although molded lead wire models satisfy the test conditions for the standard given below, this test is to check the ingress of water into the switch enclosure after submerging the Switch in water for a given time. Satisfying this test condition does not mean that the Switch can be used in water.

IEC Publication 529, degree of protection IP67.

Do not operate the Switch when it is exposed to water spray, or when water drops adhere to the Switch surface, or during sudden temperature changes, otherwise water may intrude into the interior of the Switch due to a suction effect.

Prevent the Switch from coming into contact with oil and chemicals. Otherwise, damage to or deterioration of Switch materials may result.

Do not use the Switch in areas where it is exposed to silicon adhesives, oil, or grease, otherwise faulty contact may result due to the generation of silicon oxide.

### Terminal Connection

When soldering the lead wire to the terminal, first insert the lead wire conductor through the terminal hole and then conduct soldering.

Made sure that the capacity of the soldering iron is 30 W maximum. Do not take more than 3 s to solder the switch terminal.

Improper soldering involving an excessively high temperature or excessive soldering time may deteriorate the characteristics of the Switch.

When soldering the lead wire to the PCB terminal, pay careful attention so that the flux and solder liquid level does not exceed the PCB level.

### Side-actuated (Cam/Dog) Operation

When using a cam or dog to operate the Switch, factors such as the operating speed, operating frequency, push-button indentation, and material and shape of the cam or dog will affect the durability of the Switch. Confirm performance specifications under actual operation conditions before using the Switch in applications.

## ■ Correct Use

### Mounting

Turn OFF the power supply before mounting or removing the Switch, wiring, or performing maintenance or inspection. Failure to do so may result in electric shock or burning.

For M3-screw mounting models, use M3 mounting screws with plane washers or spring washers to securely mount the Switch. Tighten the screws to a torque of 0.27 to 0.29 N·m. Exceeding the specified torque may result in deterioration of the sealing or damage.

For models with posts, secure the posts by thermal caulking or by pressing into an attached device. When pressed into an attached device, provide guides on the opposite ends of the posts to ensure that they do not fall out or rattle.

Mount the Switch onto a flat surface. Mounting on an uneven surface may cause deformation of the Switch, resulting in faulty operation or damage.

### Operating Body

Use an operating body with low frictional resistance and of a shape that will not interfere with the sealing rubber, otherwise the plunger may be damaged or the sealing may deteriorate.

### Handling

Do not handle the Switch in a way that may cause damage to the sealing rubber.

When handling the Switch, ensure that pressure is not applied to the posts in the directions shown in the following diagram. Also, ensure that uneven pressure or pressure in a direction other than the operating direction is not applied to the Actuator as shown in the following diagram. Otherwise, the post, Actuator, or Switch may be damaged, or the service life may be reduced.

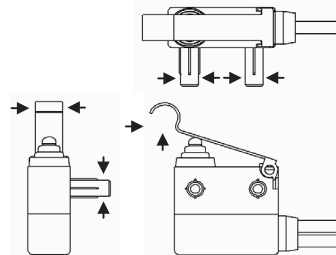

### Wiring Molded Lead Wire Models

When wiring molded lead wire models, ensure that there is no weight on the wire or that there are no sharp bends near the parts where the wire is drawn out. Otherwise, damage to the Switch or deterioration in the sealing may result.

### Using Micro Loads

Even when using micro load models within the operating range, inrush currents or surges may decrease the life expectancy of the Switch. Therefore, insert a contact protection circuit where necessary.

**ALL DIMENSIONS SHOWN ARE IN MILLIMETERS.**

To convert millimeters into inches, multiply by 0.03937. To convert grams into ounces, multiply by 0.03527.