

GENERAL PURPOSE 100 mW GaAs MMIC AMPLIFIER, 0.8 - 3.8 GHz

Typical Applications

Broadband or Narrow Band Applications:

- Cellular/PCS/3G
- Fixed Wireless & Telematics
- Cable Modem Termination Systems
- WLAN, Bluetooth & RFID

Features

- Gain: 18 dB
- P1dB Output Power: +17 dBm@ +5V
- Single Supply: +3V or +5V
- No External Components
- Integrated DC Blocks
- Ultra Small Package: SOT26

Functional Diagram

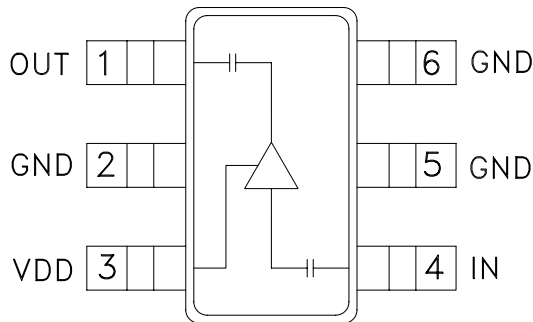

General Description

The HMC308 is a low cost MESFET MMIC amplifier that operates from a single +3 to +5V supply from 0.8 to 3.8 GHz. The surface mount SOT26 amplifier can be used as a broadband amplifier stage or used with external matching for optimized narrow band applications. With V_{dd} biased at +5V, the HMC308 offers 18 dB of gain and +20 dBm of saturated output power while requiring only 53 mA of current. This amplifier is ideal as a driver amplifier for transmitters or for use as a local oscillator (LO) amplifier to increase drive levels for passive mixers. The amplifier occupies 0.014 in² (9 mm²), making it ideal for compact radio designs.

Electrical Specifications, T_a = +25° C, as a function of V_{dd}

Parameter	V _{dd} = +3V			V _{dd} = +5V			V _{dd} = +5V			V _{dd} = +5V			Units
	Min.	Typ.	Max.	Min.	Typ.	Max.	Min.	Typ.	Max.	Min.	Typ.	Max.	
Frequency Range	2.3 - 2.7			0.8 - 2.3			2.3 - 2.7			2.7 - 3.8			GHz
Gain	13	15.5		14	18		13	16		10	13		dB
Gain Variation over Temperature		0.025	0.035		0.025	0.035		0.025	0.035		0.025	0.035	dB/°C
Input Return Loss		11			8			11			13		dB
Output Return Loss		17			13			12			13		dB
Output Power for 1 dB Compression (P1dB)	12	14		14	17		13.5	16.5		12	15		dBm
Saturated Output Power (P _{sat})		17			20			19.5			17		dBm
Output Third Order Intercept (IP3)	23	26		27	30		26	29		24	27		dBm
Noise Figure		7			7.5			7			7		dB
Supply Current (I _{dd})		50			53			53			53		mA

GENERAL PURPOSE 100 mW GaAs MMIC AMPLIFIER, 0.8 - 3.8 GHz

**Broadband Gain
& Return Loss @ Vdd = +5V**

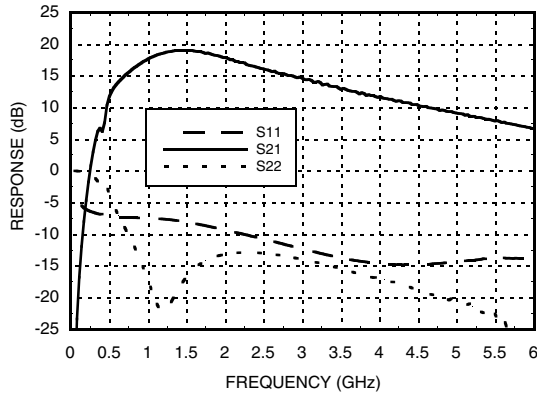

P1dB vs. Vdd Bias

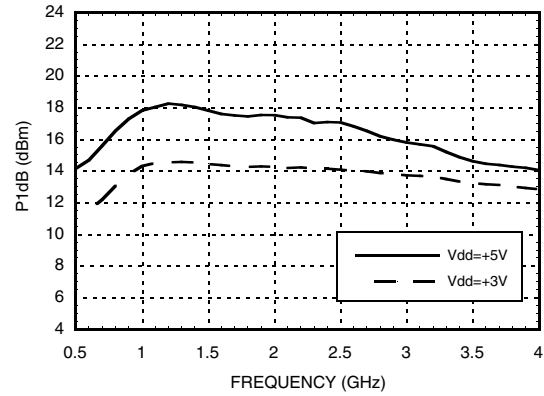

Gain vs. Temperature @ Vdd = +5V

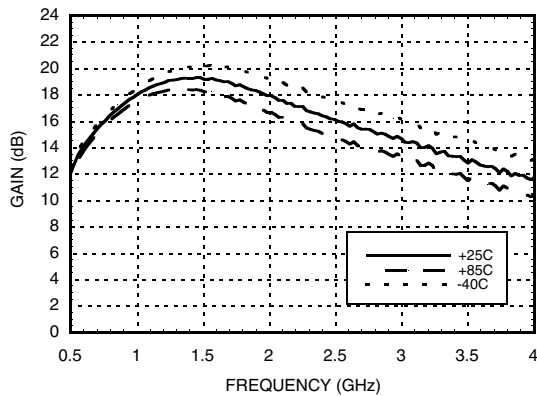

Gain vs. Temperature @ Vdd = +3V

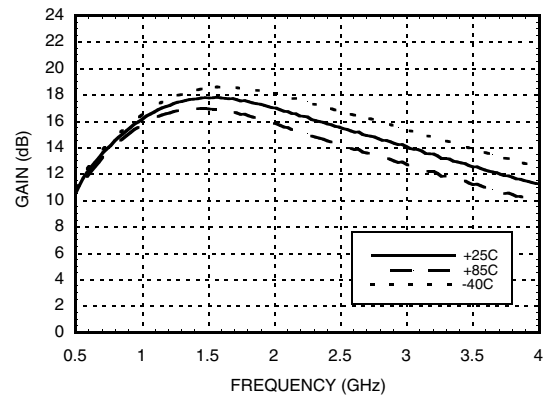

**Input & Output
Return Loss vs. Vdd Bias**

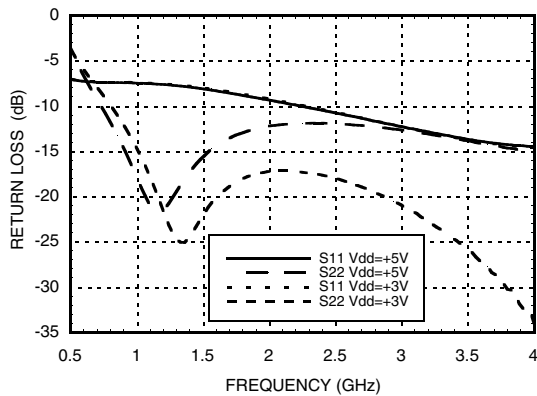

Reverse Isolation vs. Vdd Bias

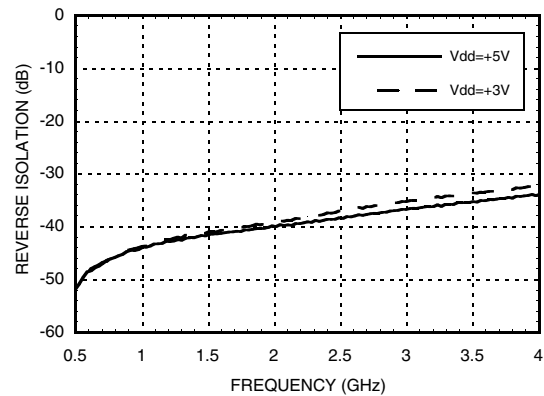

GENERAL PURPOSE 100 mW GaAs MMIC AMPLIFIER, 0.8 - 3.8 GHz

8

AMPLIFIERS - SMT

Power Compression
@ 2.0 GHz, Vdd = +5V

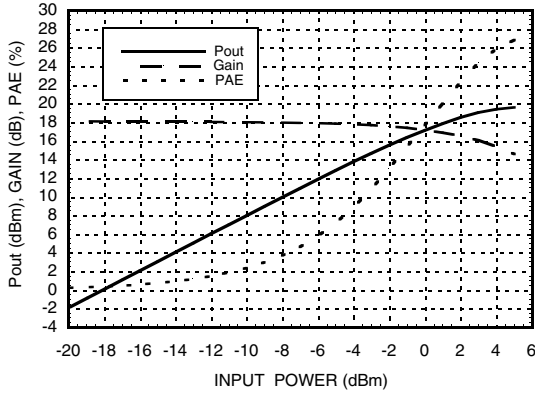

Power Compression
@ 2.5 GHz, Vdd = +5V

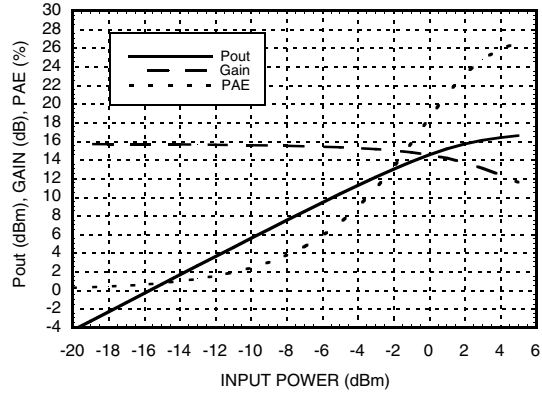

Psat vs. Temperature @ Vdd = +5V

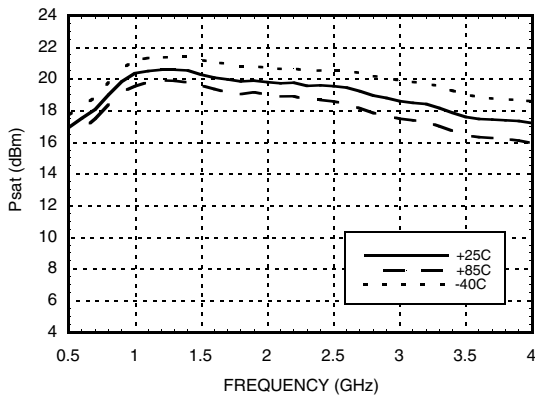

P1dB vs. Temperature @ Vdd = +5V

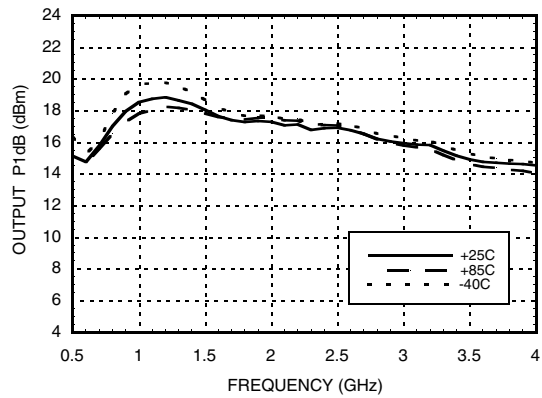

Output IP3
vs. Temperature @ Vdd = +5V

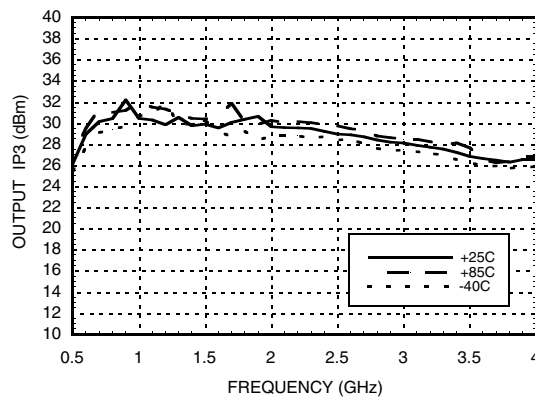

GENERAL PURPOSE 100 mW GaAs MMIC AMPLIFIER, 0.8 - 3.8 GHz

**Power Compression
@ 2.0 GHz, Vdd = +3V**

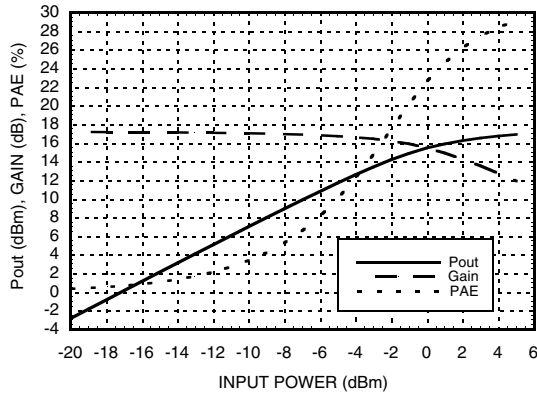

**Power Compression
@ 2.5 GHz, Vdd = +3V**

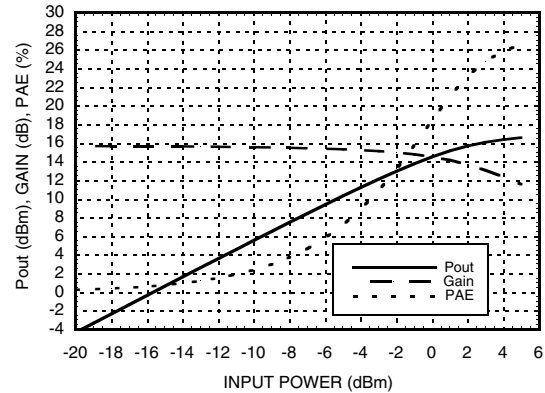

Psat vs. Temperature @ Vdd = +3V

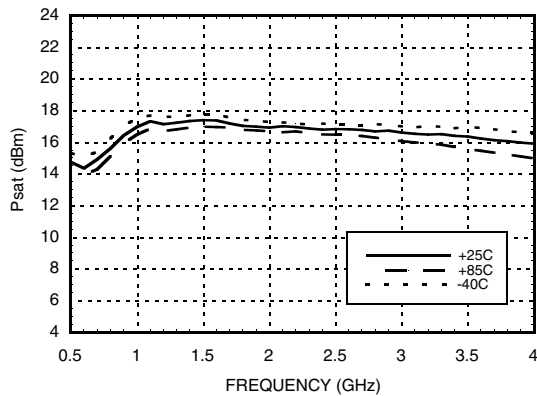

P1dB vs. Temperature @ Vdd = +3V

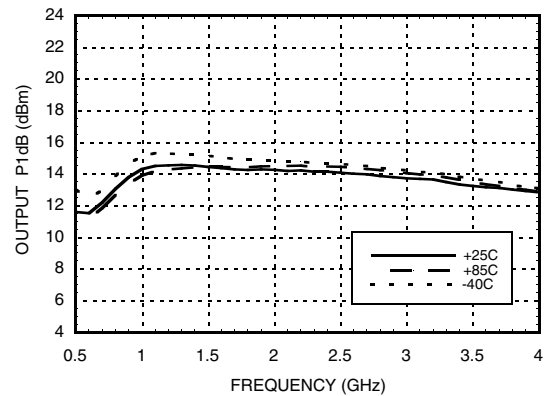

**Output IP3
vs. Temperature @ Vdd = +3V**

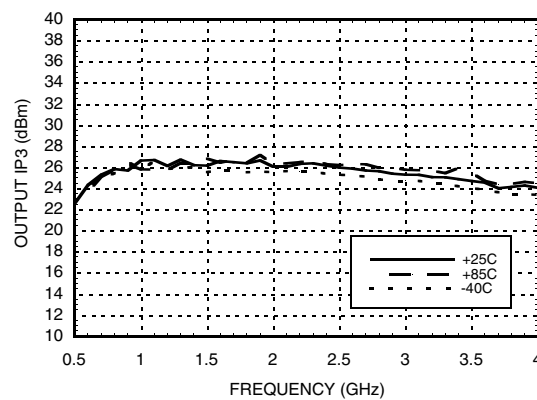

GENERAL PURPOSE 100 mW GaAs MMIC AMPLIFIER, 0.8 - 3.8 GHz

Absolute Maximum Ratings

Drain Bias Voltage (Vdd)	+7.0 Vdc
RF Input Power (RFIn)(Vdd = +5.0 Vdc)	+10 dBm
Channel Temperature	150 °C
Continuous P _{diss} (T = 85 °C) (derate 6.25 mW/°C above 85 °C)	0.406 W
Thermal Resistance (channel to lead)	160 °C/W
Storage Temperature	-65 to +150 °C
Operating Temperature	-40 to +85 °C

Typical Supply Current vs. Vdd

Vdd (Vdc)	I _{dd} (mA)
+2.5	49
+3.0	50
+3.5	51
+4.5	50
+5.0	53
+5.5	54

Outline Drawing

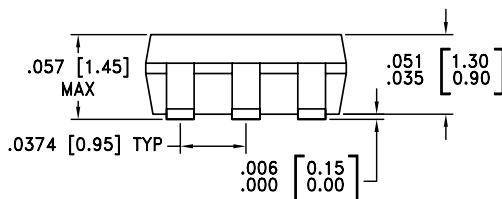
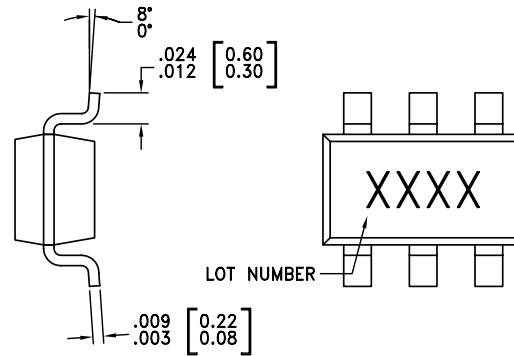
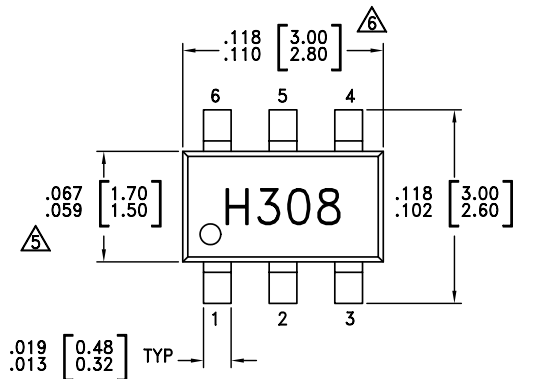



NOTES:

1. PACKAGE BODY MATERIAL: LOW STRESS INJECTION MOLDED PLASTIC SILICA AND SILICON IMPREGNATED.
2. LEADFRAME MATERIAL: COPPER ALLOY
3. LEADFRAME PLATING: Sn/Pb SOLDER
4. DIMENSIONS ARE IN INCHES [MILLIMETERS].
5. DIMENSION DOES NOT INCLUDE MOLDFLASH OF 0.15mm PER SIDE.
6. DIMENSION DOES NOT INCLUDE MOLDFLASH OF 0.25mm PER SIDE.
7. ALL GROUND LEADS MUST BE SOLDERED TO PCB RF GROUND.

GENERAL PURPOSE 100 mW GaAs MMIC AMPLIFIER, 0.8 - 3.8 GHz

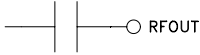
Pin Descriptions

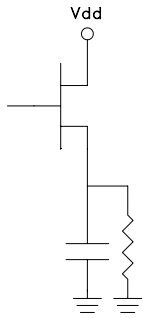
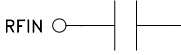
Pin Number	Function	Description	Interface Schematic
1	RF OUT	This pin is AC coupled and matched to 50 Ohms.	
2, 5, 6	GND	These pins must be connected to RF/DC ground.	
3	Vdd	Power supply voltage.	
4	RF IN	This pin is AC coupled and matched to 50 Ohms.	

GENERAL PURPOSE 100 mW GaAs MMIC AMPLIFIER, 0.8 - 3.8 GHz

Evaluation PCB

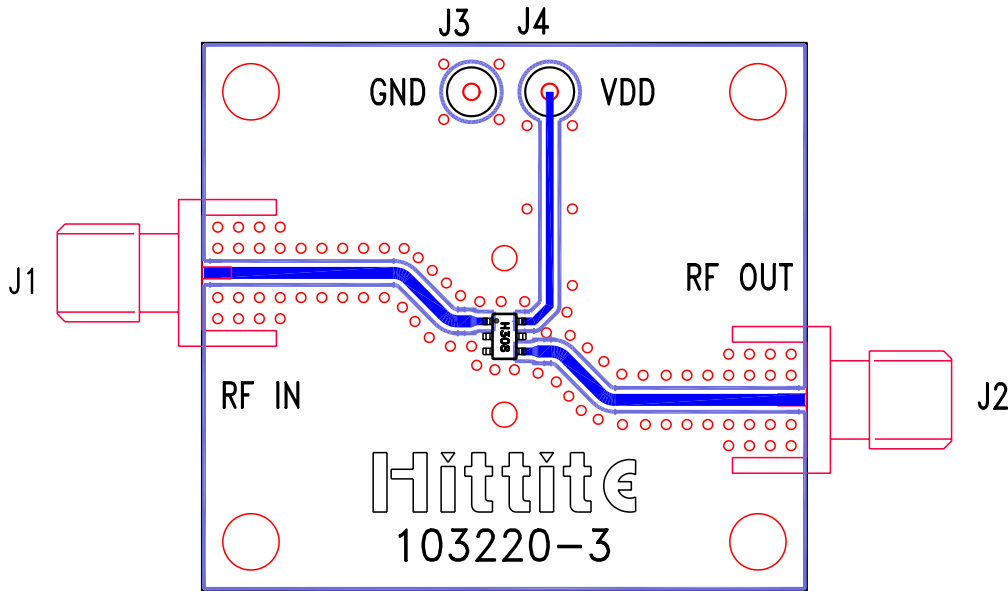

List of Material

Item	Description
J1, J2	PC Mount SMA Connector
J3, J4	DC Pins
U1	HMC308 Amplifier
PCB*	103220 Evaluation Board
*Circuit Board Material: Roger 4350	

The circuit board used in the final application should use RF circuit design techniques. Signal lines should have 50 ohm impedance while the package ground leads should be connected directly to the ground plane similar to that shown. A sufficient number of VIA holes should be used to connect the top and bottom ground planes. The evaluation circuit board shown is available from Hittite upon request.

**GENERAL PURPOSE 100 mW GaAs
MMIC AMPLIFIER, 0.8 - 3.8 GHz**

Notes: