

## 500mA, Low-Noise LDO Voltage Regulator

### FEATURES

- Low Noise: 40 $\mu$ V Possible
- High Accuracy: 1%
- Reverse Battery Protection
- Low Dropout: 340mV at Full Load
- Low Quiescent Current: 90 $\mu$ A
- Zero Off-Mode Current
- Fixed Output: 1.2V, 1.5V, 1.8V, 2.5V, 3.0V, 3.1V, 3.3V, 5.0V
- 5 Pin SOT-23, 8 Pin nSOIC and 8 pin 2X3 DFN Packages.

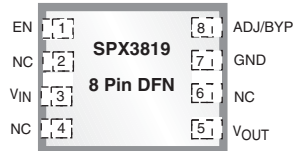

*Now Available in Lead Free Packaging*

### APPLICATIONS

- Battery Powered Systems
- Cordless Phones
- Radio Control Systems
- Portable/Palm Top/Notebook Computers
- Portable Consumer Equipment
- Portable Instrumentation
- Bar Code Scanners
- SMPS Post Regulators

### DESCRIPTION

The SPX3819 is a positive voltage regulator with a low dropout voltage and low noise output. In addition, this device offers a very low ground current of 800 $\mu$ A at 100mA output. The SPX3819 has an initial tolerance of less than 1% max and a logic compatible ON/OFF switched input. When disabled power consumption drop to nearly zero. Other key features include reverse battery protection, current limit, and thermal shutdown. The SPX3819 includes a reference bypass pin for optimal low noise output performance. With its very low output temperature coefficient, this device also makes a superior low power voltage reference.

The SPX3819 is an excellent choice for use in battery-powered applications such as cordless telephones, radio control systems, and portable computers. It is available in several fixed voltages 1.2V, 1.5V, 1.8V, 2.5V, 3.0V, 3.1V, 3.3V, 5.0V or with an adjustable output. This device is offered in 8 pin nSOIC, 8 pin DFN and 5-pin SOT-23 packages.

### TYPICAL APPLICATION CIRCUIT

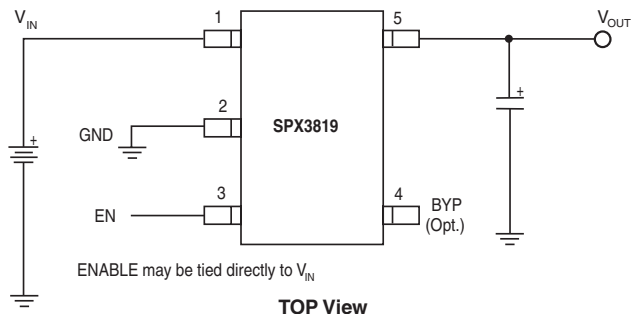

## ABSOLUTE MAXIMUM RATINGS

Power Dissipation .....	Internally Limited
Lead Temp. (Soldering, 5 Seconds) .....	260°C
Operating Junction Temperature Range .....	-40°C to +125°C
Input Supply Voltage .....	-20V to +20V
Enable Input Voltage .....	-20V to +20V

## RECOMMENDED OPERATING CONDITIONS

Input Voltage .....	+2.5V to +16V
Operating Junction Temperature Range .....	-40°C to +125°C
Enable Input Voltage .....	0V to $V_{IN}$

## ELECTRICAL CHARACTERISTICS

$T_J=25^\circ\text{C}$ ,  $V_{OUT} + 1\text{V}$ , for 1.2V Option  $V_{IN}=V_{OUT} + 1.2\text{V}$   $I_L=100\mu\text{A}$ ,  $C_L=1\mu\text{F}$ , and  $V_{ENABLE} \geq 2.4\text{V}$ . The ♦ denotes the specifications which apply over full operating temperature range  $-40^\circ\text{C}$  to  $+85^\circ\text{C}$ , unless otherwise specified.

PARAMETER	MIN	TYP	MAX	UNITS	♦	CONDITIONS
Output Voltage Tolerance	-1 -2		+1 +2	%	♦	
Output Voltage Temperature Coef.		57		ppm/°C		
Line Regulation		0.04	0.1	%/V		$V_{IN}=V_{OUT} + 1\text{V}$ to 16V
Load Regulation		0.05	0.4	%		$I_L = 0.1\text{mA}$ to 500mA
Dropout Voltage ( $V_{IN}-V_O$ )(Note 2)		10	60 80	mV	♦	$I_L = 100\mu\text{A}$
		125	175 250	mV	♦	$I_L = 50\text{mA}$
		180	350 450	mV	♦	$I_L = 150\text{mA}$
		340	550 700	mV	♦	$I_L = 500\text{mA}$
Quiescent Current ( $I_{GND}$ )		0.05	3 8	$\mu\text{A}$	♦	$V_{ENABLE} \leq 0.4\text{V}$ $V_{ENABLE} \leq 0.25\text{V}$
Ground Pin Current ( $I_{GND}$ )		90	150 190	$\mu\text{A}$	♦	$I_L = 100\mu\text{A}$
		250	650 900	$\mu\text{A}$	♦	$I_L = 50\text{mA}$
		1.0	2.0 2.5	mA	♦	$I_L = 150\text{mA}$
		6.5	25.0 30.0	mA	♦	$I_L = 500\text{mA}$
Ripple Rejection (PSRR)		70		dB		
Current Limit ( $I_{LIMIT}$ )		800	950	mA	♦	$V_{OUT} = 0\text{V}$
Output Noise ( $e_{NO}$ )		300		$\mu\text{V}_{RMS}$		$I_L=10\text{mA}$ , $C_L=1.0\mu\text{F}$ , $C_{IN}=1\mu\text{F}$ , (10Hz-100kHz)
		40		$\mu\text{V}_{RMS}$		$I_L=10\text{mA}$ , $C_L=10\mu\text{F}$ , $C_{BYP}=1\mu\text{F}$ , $C_{IN}=1\mu\text{F}$ , (10Hz-100kHz)
Input Voltage Level Logic Low ( $V_{IL}$ )			0.4	V		OFF
Input Voltage Level Logic High ( $V_{IH}$ )	2			V		ON
ENABLE Input Current		0.01 3	2 20	$\mu\text{A}$		$V_{IL} \leq 0.4\text{V}$ $V_{IH} \geq 2.0\text{V}$
Thermal Resistance (Note 1)		220		°C/W	♦	SOT-23-5 / Junction to Ambient
		180		°C/W	♦	SO-8 / Junction to Ambient

### NOTES

**Note 1:** The maximum allowable power dissipation is a function of maximum operating junction temperature,  $T_{J(max)}$  the junction to ambient thermal resistance, and the ambient  $\theta_{JA}$ , and the ambient temperature  $T_A$ . The maximum allowable power dissipation at any ambient temperature is given:  $P_{D(max)} = (T_{J(max)} - T_A) / \theta_{JA}$ , exceeding the maximum allowable power limit will result in excessive die temperature; thus, the regulator will go into thermal shutdown. The  $\theta_{JA}$  of the SPX3819 is 220°C/W mounted on a PC board.

**Note 2:** Not applicable to output voltage 2V or less.

# TYPICAL PERFORMANCE CHARACTERISTICS

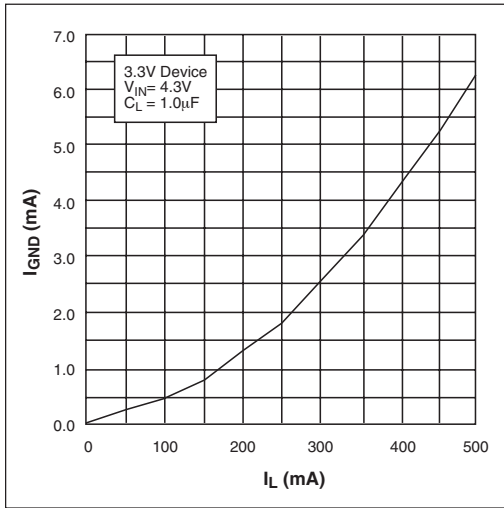

Ground Current vs Load Current

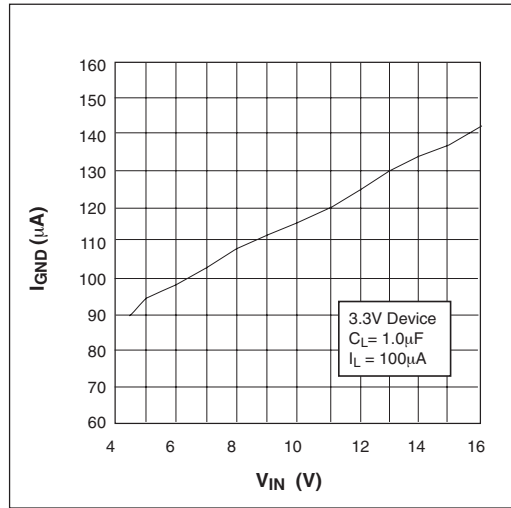

Ground Current vs Input Voltage

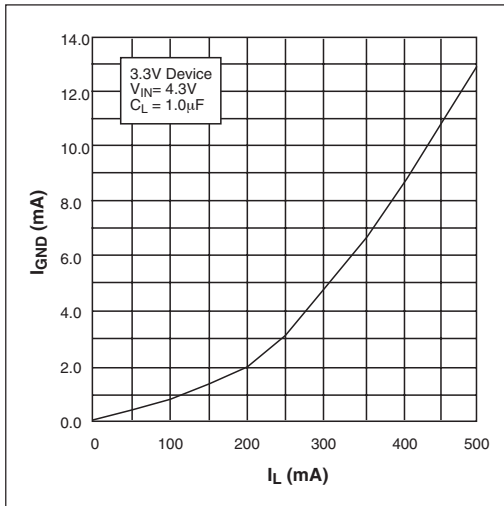

Ground Current vs Load Current in Dropout

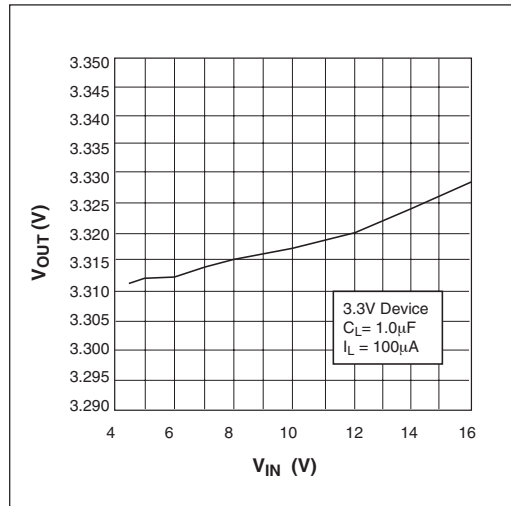

Output Voltage vs Input Voltage

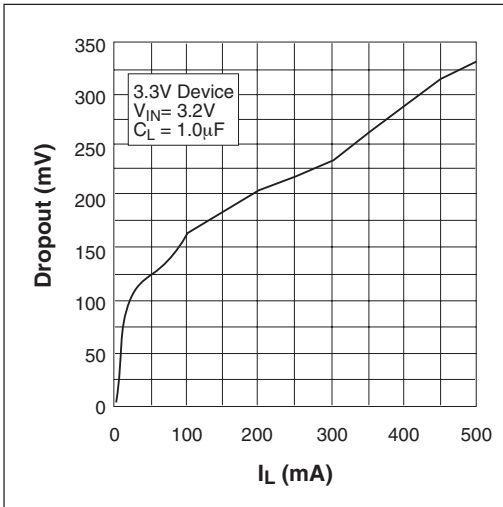

Dropout Voltage vs Load Current

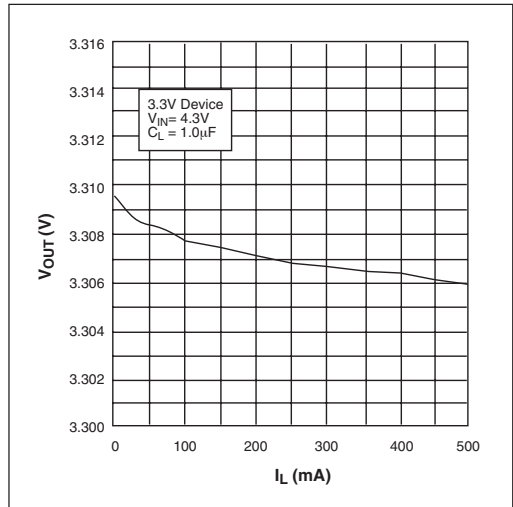

Output Voltage vs Load Current

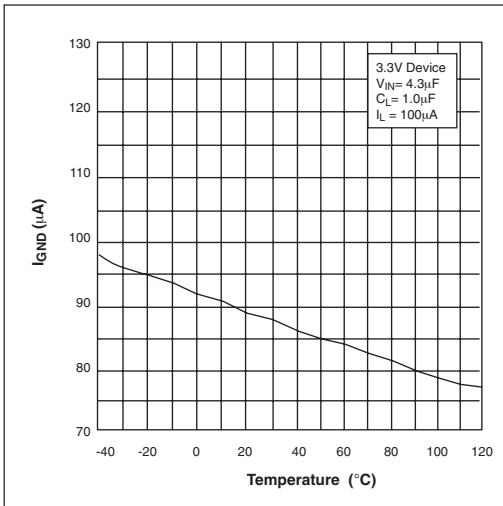

Ground Current vs Temperature with 100uA Load

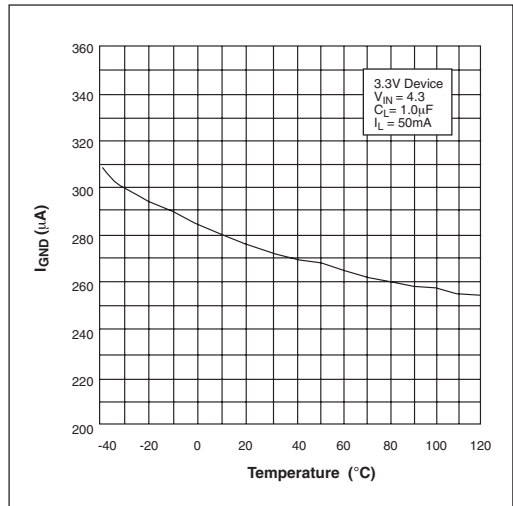

Ground Current vs Temperature with 50mA Load

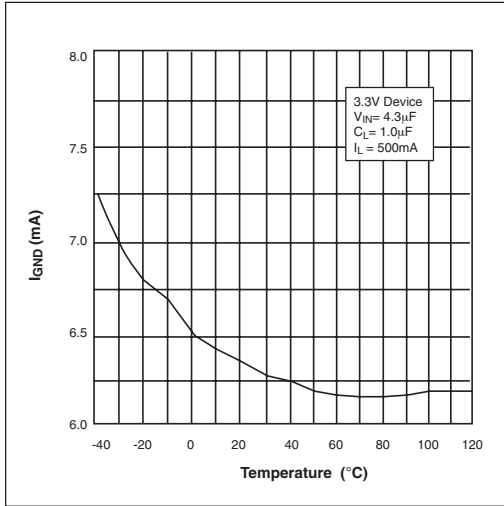

Ground Current vs Temperature with 500mA Load

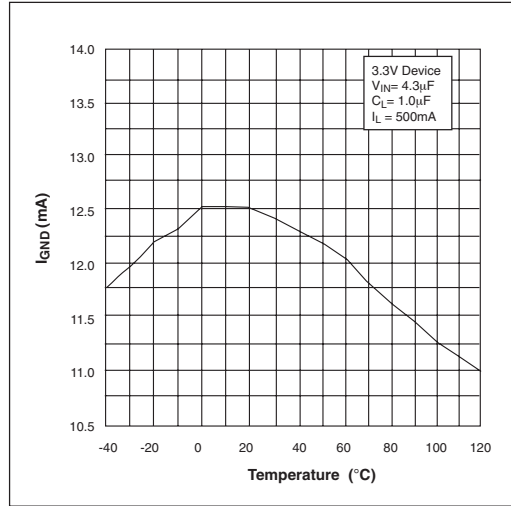

Ground Current vs Temperature in Dropout

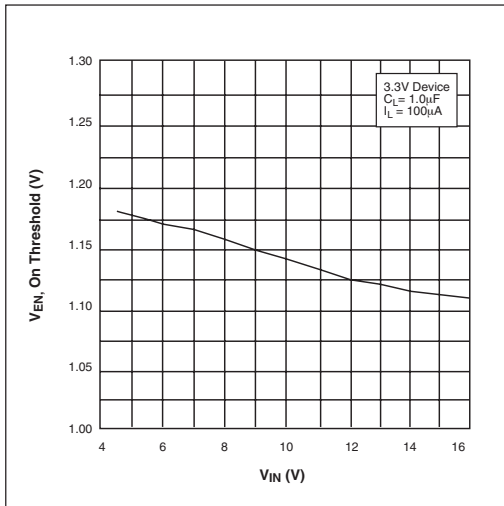

ENABLE Voltage, ON threshold, vs Input Voltage

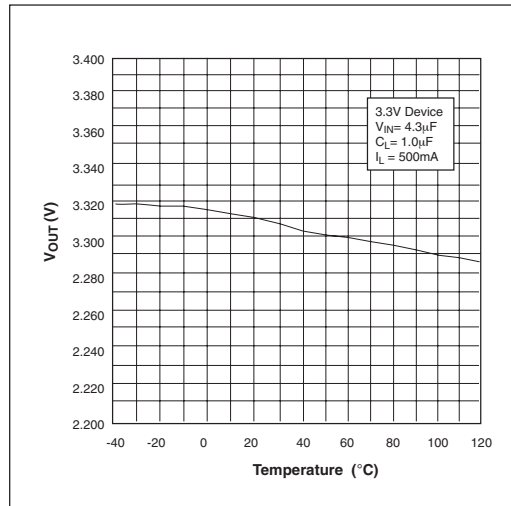

Output Voltage vs Temperature

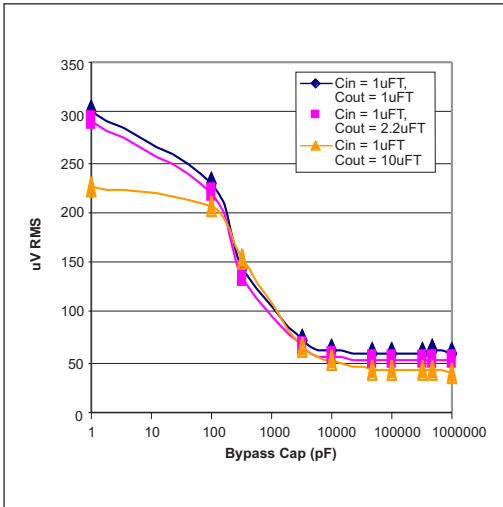

Output Noise vs Bypass Capacitor Value  $I_L = 10mA$ , 10Hz - 100kHz

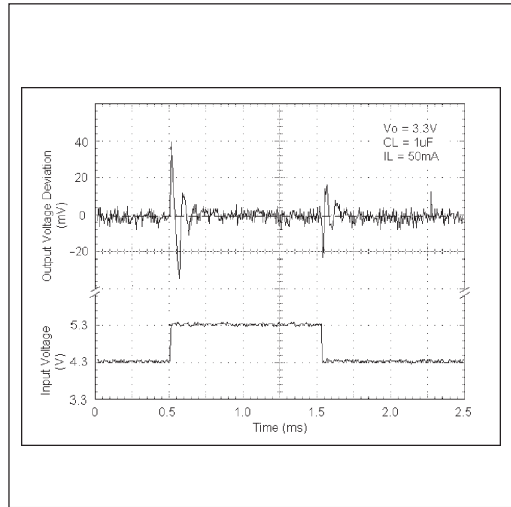

Line Transient Response for 3.3V Device

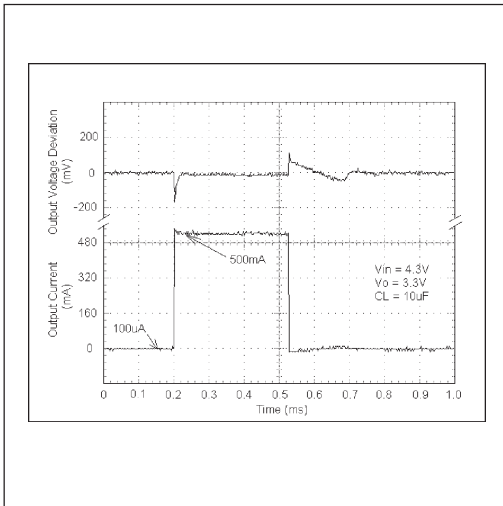

Load Transient Response for 3.3V Device

The SPX3819 requires an output capacitor for device stability. Its value depends upon the application circuit. In general, linear regulator stability decreases with higher output currents. In applications where the SPX3819 is putting out less current, a lower output capacitance may be sufficient. For example, a regulator sourcing only 10mA, requires approximately half the capacitance as the same regulator sourcing 150mA.

Bench testing is the best method for determining the proper type and value of the capacitor since the high frequency characteristics of electrolytic capacitors vary widely, depending on type and manufacturer. A high quality 2.2 $\mu$ F aluminum electrolytic capacitor works in most application circuits, but the same stability often can be obtained with a 1 $\mu$ F tantalum electrolytic.

With the SPX3819 adjustable version, the minimum value of output capacitance is a function of the output voltage. The value decreases with higher output voltages, since closed loop gain is increased.

### Typical Applications Circuits

A 10nF capacitor on BYP pin will significantly reduce output noise but it may be left unconnected if the output noise is not a major concern.

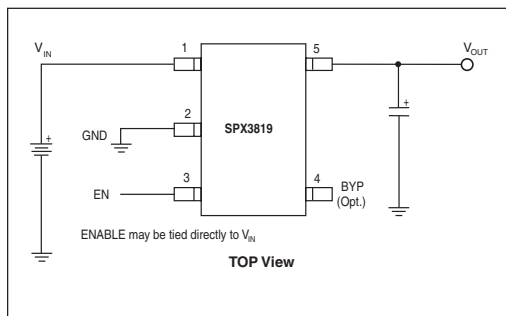

Figure 1. Standard Application Circuit

The SPX3819 start-up speed is inversely proportional to the size of the BYP capacitor. Applications requiring a slow ramp-up of the output voltage should use a larger  $C_{BYP}$ . However, if a rapid turn-on is necessary, the BYP capacitor can be omitted.

The SPX3819's internal reference is available through the BYP pin.

Figure 1 represents a SPX3819 standard application circuit. The EN (enable) pin is pulled high (>2.0V) to enable the regulator.

To disable the regulator,  $EN < 0.4V$ .

The SPX3819 in Figure 2 illustrates a typical adjustable output voltage configuration. Two resistors ( $R_1$  and  $R_2$ ) set the output voltage. The output voltage is calculated using the formula:

$$V_{OUT} = 1.235V \times [1 + R_1/R_2]$$

$R_2$  must be > 10 k $\Omega$  and for best results,  $R_2$  should be between 22 k $\Omega$  and 47k $\Omega$ . A capacitor placed between Adj and ground will provide improved noise performance.

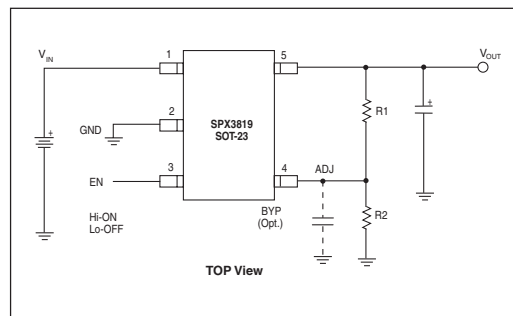
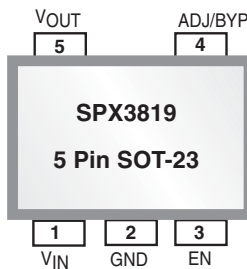
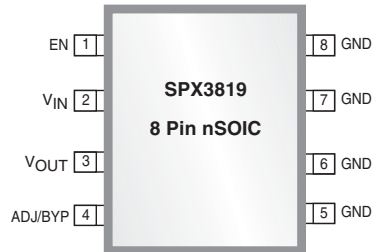
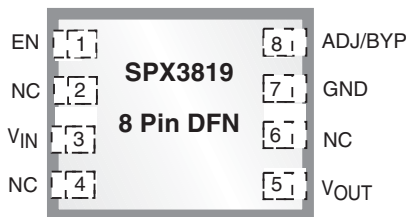

Figure 2. Typical Adjustable Output Voltage Configuration

## PACKAGE: PIN DESCRIPTION

Pin # nSOIC	Pin # DFN	Pin # SOT-3	Pin Name	Description
2	3	1	V <sub>IN</sub>	Supply Input
5-8	7	2	GND	Ground
3	5	5	V <sub>OUT</sub>	Regulator Output
1	1	3	EN	Enable(input). CMOS compatible control input. Logic high = enable; logic low or open = shutdown
4	8	4	ADJ/BYP	Adjust(input). Feedback input. Connect to resistive voltage-divider network
-	4, 6	-	NC	No Connect

## PACKAGE: PINOUTS





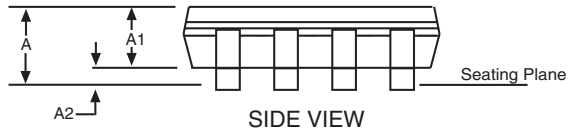
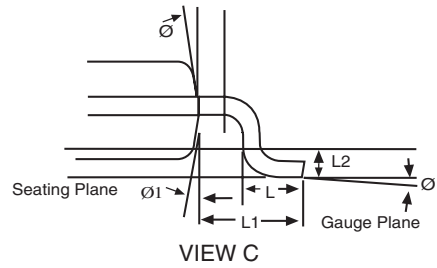
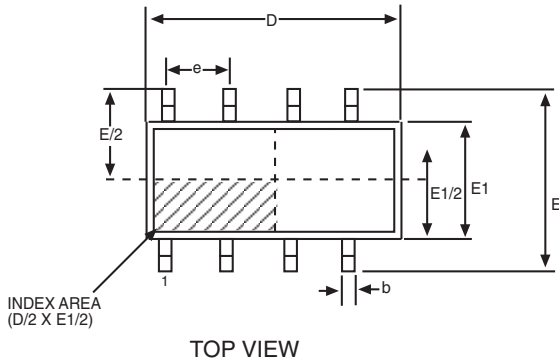

8 Pin NSOIC JEDEC MO-012 (AA) Variation			
SYMBOL	MIN	NOM	MAX
A	1.35	-	1.75
A1	0.1	-	0.25
A2	1.25	-	1.65
b	0.31	-	0.51
c	0.17	-	0.24
D	4.90 BSC		
E	6.00 BSC		
E1	3.90 BSC		
e	1.27 BSC		
L	0.4	-	1.27
L1	1.04 REF		
L2	0.25 BSC		
ø	0°	-	8°
ø1	5°	-	15°

Note: Dimensions in (mm)

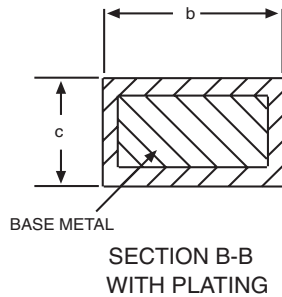
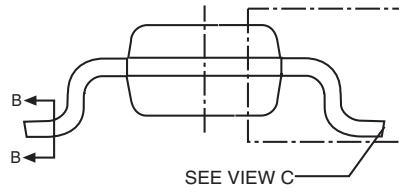

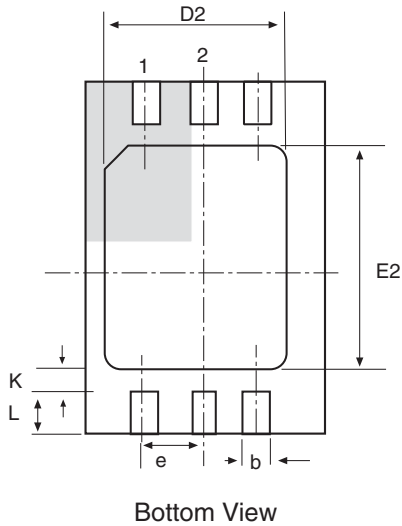
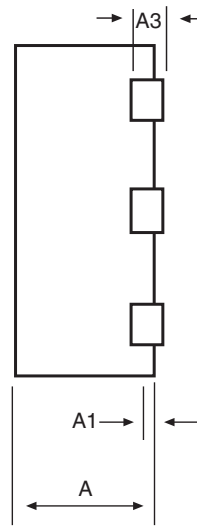
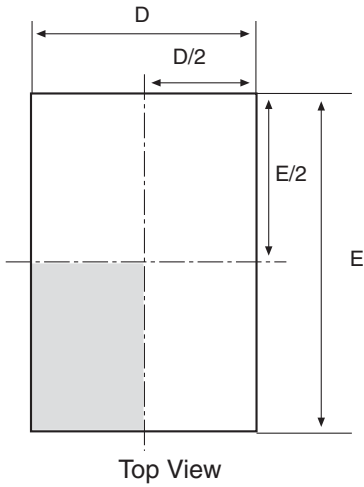

2x3 8 Pin DFN JEDEC MO-229 (VCED-2) VARIATION			
SYMBOL	MIN	NOM	MAX
A	0.8	0.9	1
A1	0	0.02	0.05
A2	0.55	0.65	0.8
A3	0.20 REF		
b	0.18	0.25	0.3
D	2.00 BSC		
D2	1.5		1.75
e	-	0.5	-
E	3.00 BSC		
E2	1.6	-	1.9
K	0.2	-	-
L	0.3	0.4	0.5

Note: Dimensions in (mm)

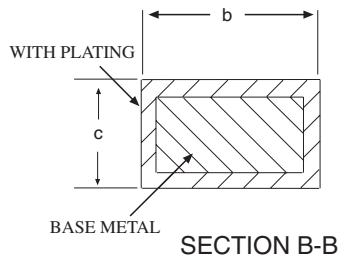
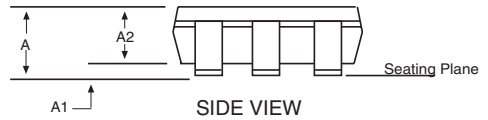
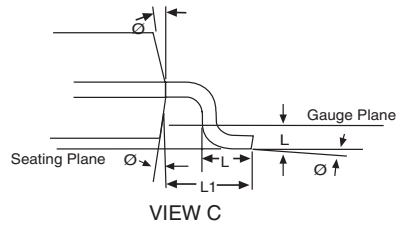
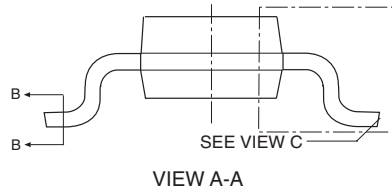
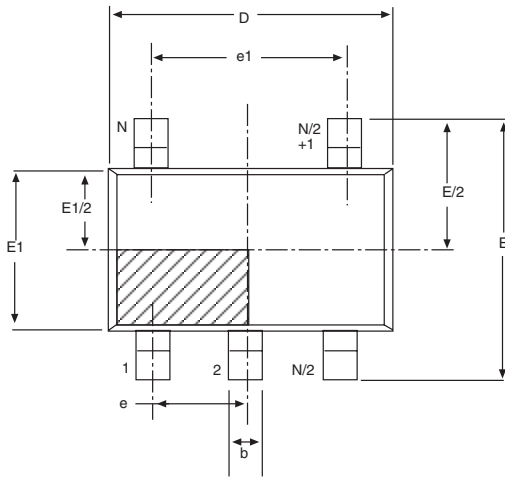

5 Pin SOT-23 JEDEC MO-178 (AA) Variation			
SYMBOL	MIN	NOM	MAX
A	-	-	1.45
A1	0	-	0.15
A2	0.9	1.15	1.3
b	0.3	-	0.5
c	0.08	-	0.22
D		2.90 BSC	
E		2.80 BSC	
E1		1.60 BSC	
e		0.95 BSC	
e1		1.90 BSC	
L	0.3	0.45	0.6
L1		0.60 REF	
L2		0.25 BSC	
$\theta$	0°	4°	8°
$\emptyset$	5°	10°	15°

Note: Dimensions in (mm)

<b>PART NUMBERS</b>	<b>TOP MARK</b>	<b>PACKAGE TYPE</b>
SPX3819M5.....	G1WW.....	5 Pin SOT-23
SPX3819M5/TR.....	G1WW.....	5 Pin SOT-23
SPX3819M5-1.2.....	A4WW.....	5 Pin SOT-23
SPX3819M5-1.2/TR.....	A4WW.....	5 Pin SOT-23
SPX3819M5-1.5.....	W3WW.....	5 Pin SOT-23
SPX3819M5-1.5/TR.....	W3WW.....	5 Pin SOT-23
SPX3819M5-1.8.....	G3WW.....	5 Pin SOT-23
SPX3819M5-1.8/TR.....	G3WW.....	5 Pin SOT-23
SPX3819M5-2.5.....	H3WW.....	5 Pin SOT-23
SPX3819M5-2.5/TR.....	H3WW.....	5 Pin SOT-23
SPX3819M5-3.0.....	J3WW.....	5 Pin SOT-23
SPX3819M5-3.0/TR.....	J3WW.....	5 Pin SOT-23
SPX3819M5-3.1.....	K3WW.....	5 Pin SOT-23
SPX3819M5-3.1/TR.....	K3WW.....	5 Pin SOT-23
SPX3819M5-3.3.....	L3WW.....	5 Pin SOT-23
SPX3819M5-3.3/TR.....	L3WW.....	5 Pin SOT-23
SPX3819M5-5.0.....	M3WW.....	5 Pin SOT-23
SPX3819M5-5.0/TR.....	M3WW.....	5 Pin SOT-23

Available in lead free packaging. To order add "-L" suffix to part number.

Example: SPX3819M5-5.0/TR = standard; SPX3819M5-L-5.0/TR = lead free

/TR = Tape and Reel

Pack quantity is 2500 for SOT-23 or NSOIC and 3000 for DFN .

---

 [CLICK HERE TO ORDER SAMPLES](#) 



**ANALOG EXCELLENCE**

**Sipex Corporation**

**Headquarters and  
Sales Office**  
233 South Hillview Drive  
Milpitas, CA 95035  
TEL: (408) 934-7500  
FAX: (408) 935-7600

<b>PART NUMBERS</b>	<b>TOP MARK</b>	<b>PACKAGE TYPE</b>
SPX3819R-1.2.....	3819S12YWW.....	8 Pin DFN
SPX3819R-1.2/TR.....	3819S12YWW.....	8 Pin DFN
SPX3819R-1.5.....	3819S15YWW.....	8 Pin DFN
SPX3819R-1.5/TR.....	3819S15YWW.....	8 Pin DFN
SPX3819S-1.8.....	3819S18YYWW.....	8 Pin nSOIC
SPX3819S-1.8/TR.....	3819S18YYWW.....	8 Pin nSOIC
SPX3819S-2.5.....	3819S25YYWW.....	8 Pin nSOIC
SPX3819S-2.5/TR.....	3819S25YYWW.....	8 Pin nSOIC
SPX3819S-3.0.....	3819S30YYWW.....	8 Pin nSOIC
SPX3819S-3.0/TR.....	3819S30YYWW.....	8 Pin nSOIC
SPX3819S-3.3.....	3819S33YYWW.....	8 Pin nSOIC
SPX3819S-3.3/TR.....	3819S33YYWW.....	8 Pin nSOIC
SPX3819S-5.0.....	3819S50YYWW.....	8 Pin nSOIC
SPX3819S-5.0/TR.....	3819S50YYWW.....	8 Pin nSOIC
SPX3819S.....	3819SYYWW.....	8 Pin nSOIC
SPX3819S/TR.....	3819SYYWW.....	8 Pin nSOIC

Available in lead free packaging. To order add "-L" suffix to part number.

Example: SPX3819R-3.3/TR = standard; SPX3819R-L-3.3/TR = lead free

/TR = Tape and Reel

Pack quantity is 2500 for SOT-23 or NSOIC and 3000 for DFN .

[CLICK HERE TO ORDER SAMPLES](#)



**ANALOG EXCELLENCE**

**Sipex Corporation**

**Headquarters and Sales Office**

233 South Hillview Drive  
 Milpitas, CA 95035  
 TEL: (408) 934-7500  
 FAX: (408) 935-7600

Sipex Corporation reserves the right to make changes to any products described herein. Sipex does not assume any liability arising out of the application or use of any product or circuit described herein; neither does it convey any license under its patent rights nor the rights of others.