



## 28F010 1024K (128K x 8) CMOS FLASH MEMORY

- **Flash Electrical Chip-Erase**
  - 1 Second Typical Chip-Erase
- **Quick Pulse Programming Algorithm**
  - 10  $\mu$ s Typical Byte-Program
  - 2 Second Chip-Program
- **100,000 Erase/Program Cycles**
- **12.0V  $\pm$  5%  $V_{pp}$**
- **High-Performance Read**
  - 65 ns Maximum Access Time
- **CMOS Low Power Consumption**
  - 10 mA Typical Active Current
  - 50  $\mu$ A Typical Standby Current
  - 0 Watts Data Retention Power
- **Integrated Program/Erase Stop Timer**
- **Command Register Architecture for Microprocessor/Microcontroller Compatible Write Interface**
- **Noise Immunity Features**
  - $\pm$  10%  $V_{CC}$  Tolerance
  - Maximum Latch-Up Immunity through EPI Processing
- **ETOX™ Nonvolatile Flash Technology**
  - EPROM-Compatible Process Base
  - High-Volume Manufacturing Experience
- **JEDEC-Standard Pinouts**
  - 32-Pin Plastic Dip
  - 32-Lead PLCC
  - 32-Lead TSOP

(See Packaging Spec., Order #231369)
- **Extended Temperature Options**

Intel's 28F010 CMOS flash memory offers the most cost-effective and reliable alternative for read/write random access nonvolatile memory. The 28F010 adds electrical chip-erase and reprogramming to familiar EPROM technology. Memory contents can be rewritten: in a test socket; in a PROM-programmer socket; on-board during subassembly test; in-system during final test; and in-system after-sale. The 28F010 increases memory flexibility, while contributing to time and cost savings.

The 28F010 is a 1024 kilobit nonvolatile memory organized as 131,072 bytes of 8 bits. Intel's 28F010 is offered in 32-pin plastic dip or 32-lead PLCC and TSOP packages. Pin assignments conform to JEDEC standards for byte-wide EPROMs.

Extended erase and program cycling capability is designed into Intel's ETOX (EPROM Tunnel Oxide) process technology. Advanced oxide processing, an optimized tunneling structure, and lower electric field combine to extend reliable cycling beyond that of traditional EEPROMs. With the 12.0V  $V_{pp}$  supply, the 28F010 performs 100,000 erase and program cycles well within the time limits of the Quick Pulse Programming and Quick Erase algorithms.

Intel's 28F010 employs advanced CMOS circuitry for systems requiring high-performance access speeds, low power consumption, and immunity to noise. Its 65 nanosecond access time provides no-WAIT-state performance for a wide range of microprocessors and microcontrollers. Maximum standby current of 100  $\mu$ A translates into power savings when the device is deselected. Finally, the highest degree of latch-up protection is achieved through Intel's unique EPI processing. Prevention of latch-up is provided for stresses up to 100 mA on address and data pins, from  $-1V$  to  $V_{CC} + 1V$ .

With Intel's ETOX process base, the 28F010 builds on years of EPROM experience to yield the highest levels of quality, reliability, and cost-effectiveness.

\*Other brands and names are the property of their respective owners.  
Information in this document is provided in connection with Intel products. Intel assumes no liability whatsoever, including infringement of any patent or copyright, for sale and use of Intel products except as provided in Intel's Terms and Conditions of Sale for such products. Intel retains the right to make changes to these specifications at any time, without notice. Microcomputer Products may have minor variations to this specification known as errata.  
COPYRIGHT © INTEL CORPORATION, 1995

November 1995

Order Number: 290207-010

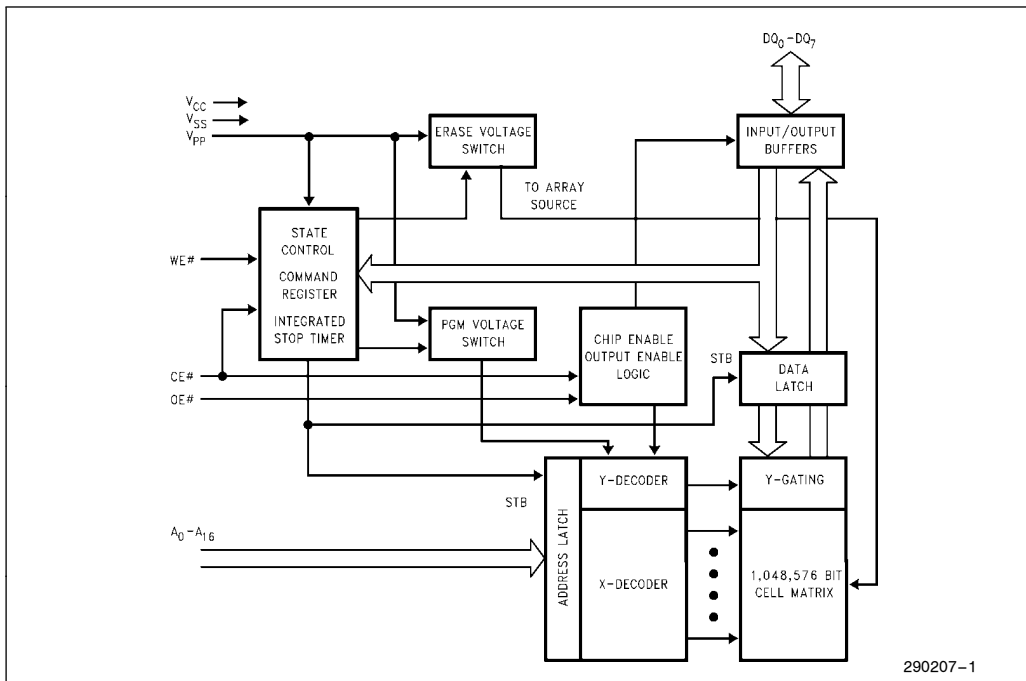

Figure 1. 28F010 Block Diagram

Table 1. Pin Description

Symbol	Type	Name and Function
A <sub>0</sub> -A <sub>16</sub>	INPUT	<b>ADDRESS INPUTS</b> for memory addresses. Addresses are internally latched during a write cycle.
DQ <sub>0</sub> -DQ <sub>7</sub>	INPUT/OUTPUT	<b>DATA INPUT/OUTPUT:</b> Inputs data during memory write cycles; outputs data during memory read cycles. The data pins are active high and float to tri-state OFF when the chip is deselected or the outputs are disabled. Data is internally latched during a write cycle.
CE #	INPUT	<b>CHIP ENABLE:</b> Activates the device's control logic, input buffers, decoders and sense amplifiers. CE # is active low; CE # high deselects the memory device and reduces power consumption to standby levels.
OE #	INPUT	<b>OUTPUT ENABLE:</b> Gates the devices output through the data buffers during a read cycle. OE # is active low.
WE #	INPUT	<b>WRITE ENABLE:</b> Controls writes to the control register and the array. Write enable is active low. Addresses are latched on the falling edge and data is latched on the rising edge of the WE # pulse. <b>Note:</b> With V <sub>PP</sub> ≤ 6.5V, memory contents cannot be altered.
V <sub>PP</sub>		<b>ERASE/PROGRAM POWER SUPPLY</b> for writing the command register, erasing the entire array, or programming bytes in the array.
V <sub>CC</sub>		<b>DEVICE POWER SUPPLY</b> (5V ± 10%)
V <sub>SS</sub>		<b>GROUND</b>
NC		<b>NO INTERNAL CONNECTION</b> to device. Pin may be driven or left floating.

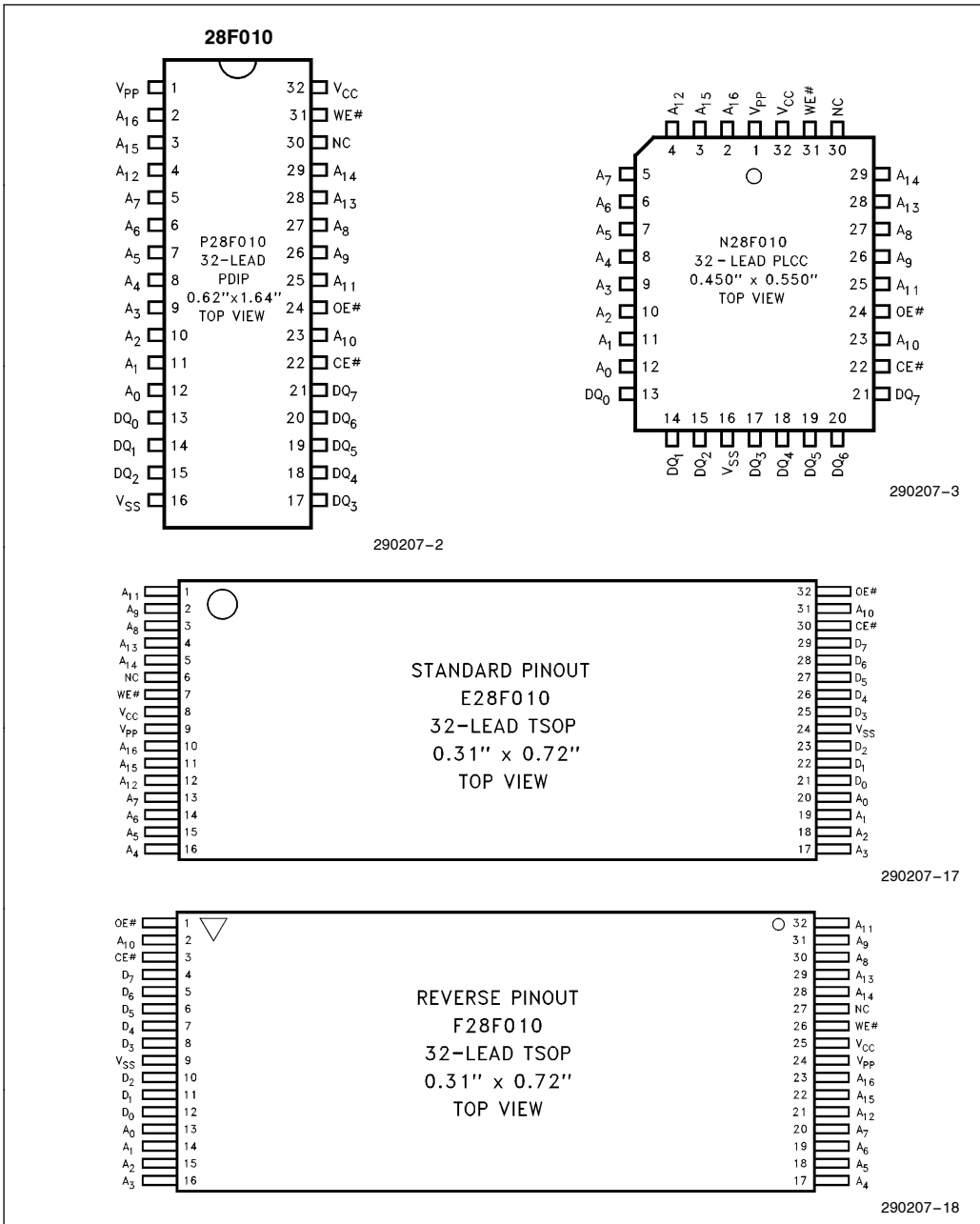

Figure 2. 28F010 Pin Configurations

## APPLICATIONS

The 28F010 flash memory provides nonvolatility along with the capability to perform over 100,000 electrical chip-erase/reprogram cycles. These features make the 28F010 an innovative alternative to disk, EEPROM, and battery-backed static RAM. Where periodic updates of code and data-tables are required, the 28F010's reprogrammability and nonvolatility make it the obvious and ideal replacement for EPROM.

Primary applications and operating systems stored in flash eliminate the slow disk-to-DRAM download process. This results in dramatic enhancement of performance and substantial reduction of power consumption — a consideration particularly important in portable equipment. Flash memory increases flexibility with electrical chip erasure and in-system update capability of operating systems and application code. With updatable code, system manufacturers can easily accommodate last-minute changes as revisions are made.

In diskless workstations and terminals, network traffic reduces to a minimum and systems are instant-on. Reliability exceeds that of electromechanical media. Often in these environments, power interruptions force extended re-boot periods for all networked terminals. This mishap is no longer an issue if boot code, operating systems, communication protocols and primary applications are flash-resident in each terminal.

For embedded systems that rely on dynamic RAM/disk for main system memory or nonvolatile backup storage, the 28F010 flash memory offers a solid state alternative in a minimal form factor. The 28F010 provides higher performance, lower power consumption, instant-on capability, and allows an "execute in place" memory hierarchy for code and data table reading. Additionally, the flash memory is more rugged and reliable in harsh environments where extreme temperatures and shock can cause disk-based systems to fail.

The need for code updates pervades all phases of a system's life — from prototyping to system manufacture to after-sale service. The electrical chip-erase and reprogramming ability of the 28F010 allows in-circuit alterability; this eliminates unnecessary handling and less-reliable socketed connections, while adding greater test, manufacture, and update flexibility.

Material and labor costs associated with code changes increases at higher levels of system integration — the most costly being code updates after sale. Code "bugs", or the desire to augment system functionality, prompt after-sale code updates. Field revisions to EPROM-based code requires the removal of EPROM components or entire boards. With the 28F010, code updates are implemented locally via an edge-connector, or remotely over a communication link.

For systems currently using a high-density static RAM/battery configuration for data accumulation, flash memory's inherent nonvolatility eliminates the need for battery backup. The concern for battery failure no longer exists, an important consideration for portable equipment and medical instruments, both requiring continuous performance. In addition, flash memory offers a considerable cost advantage over static RAM.

Flash memory's electrical chip erasure, byte programmability and complete nonvolatility fit well with data accumulation and recording needs. Electrical chip-erase gives the designer a "blank slate" in which to log or record data. Data can be periodically off-loaded for analysis and the flash memory erased producing a new "blank slate".

A high degree of on-chip feature integration simplifies memory-to-processor interfacing. Figure 4 depicts two 28F010s tied to the 80C186 system bus. The 28F010's architecture minimizes interface circuitry needed for complete in-circuit updates of memory contents.

The outstanding feature of the TSOP (Thin Small Outline Package) is the 1.2 mm thickness. With standard and reverse pin configurations, TSOP reduces the number of board layers and overall volume necessary to layout multiple 28F010s. TSOP is particularly suited for portable equipment and applications requiring large amounts of flash memory. Figure 3 illustrates the TSOP Serpentine layout.

With cost-effective in-system reprogramming, extended cycling capability, and true nonvolatility, the 28F010 offers advantages to the alternatives: EPROMs, EEPROMs, battery backed static RAM, or disk. EPROM-compatible read specifications, straight-forward interfacing, and in-circuit alterability offers designers unlimited flexibility to meet the high standards of today's designs.



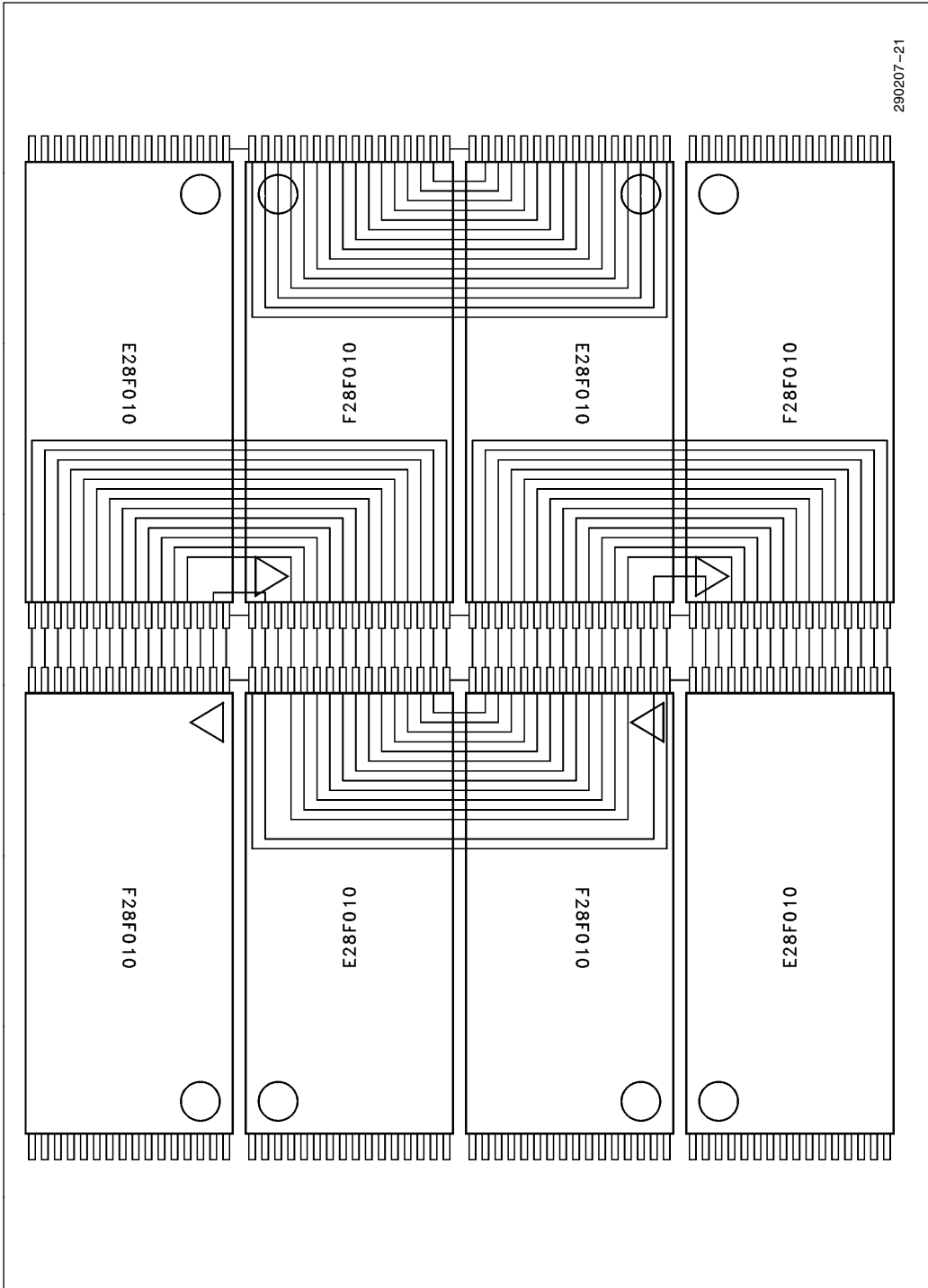

Figure 3. TSOP Serpentine Layout

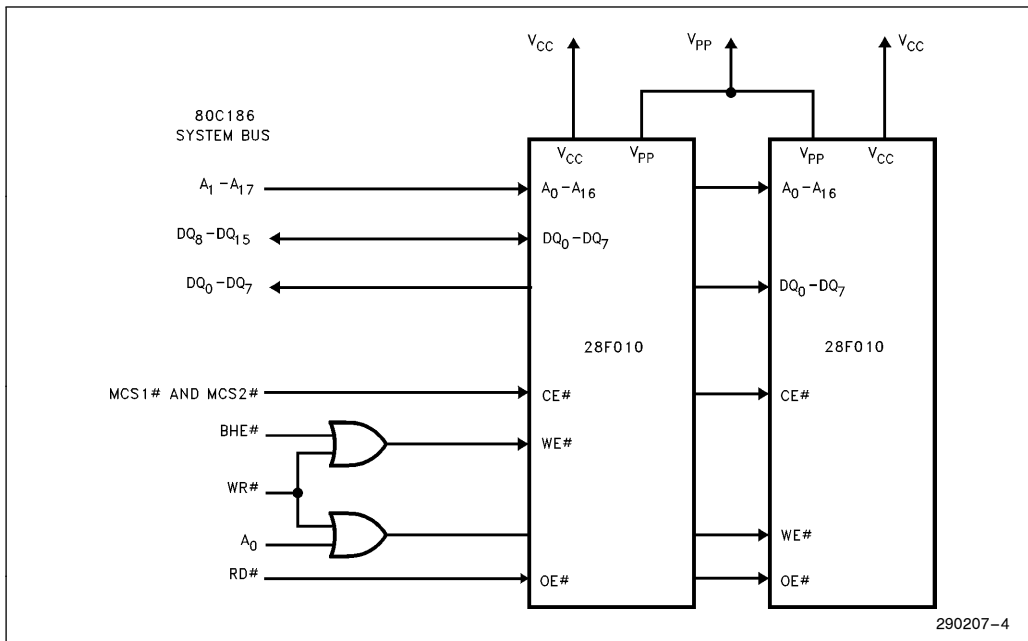

Figure 4. 28F010 in a 80C186 System

## PRINCIPLES OF OPERATION

Flash-memory augments EPROM functionality with in-circuit electrical erasure and reprogramming. The 28F010 introduces a command register to manage this new functionality. The command register allows for: 100% TTL-level control inputs; fixed power supplies during erasure and programming; and maximum EPROM compatibility.

In the absence of high voltage on the  $V_{PP}$  pin, the 28F010 is a read-only memory. Manipulation of the external memory-control pins yields the standard EPROM read, standby, output disable, and Intelligent Identifier operations.

The same EPROM read, standby, and output disable operations are available when high voltage is applied to the  $V_{PP}$  pin. In addition, high voltage on  $V_{PP}$  enables erasure and programming of the device. All functions associated with altering memory contents—Intelligent Identifier, erase, erase verify, program, and program verify—are accessed via the command register.

Commands are written to the register using standard microprocessor write timings. Register contents serve as input to an internal state-machine which controls the erase and programming circuitry. Write cycles also internally latch addresses and data

needed for programming or erase operations. With the appropriate command written to the register, standard microprocessor read timings output array data, access the Intelligent Identifier codes, or output data for erase and program verification.

## Integrated Stop Timer

Successive command write cycles define the durations of program and erase operations; specifically, the program or erase time durations are normally terminated by associated program or erase verify commands. An integrated stop timer provides simplified timing control over these operations; thus eliminating the need for maximum program/erase timing specifications. Programming and erase pulse durations are minimums only. When the stop timer terminates a program or erase operation, the device enters an inactive state and remains inactive until receiving the appropriate verify or reset command.

## Write Protection

The command register is only active when  $V_{PP}$  is at high voltage. Depending upon the application, the system designer may choose to make the  $V_{PP}$  power supply switchable—available only when memory updates are desired. When  $V_{PP} = V_{PPL}$ , the con-

**Table 2. 28F010 Bus Operations**

Mode		V <sub>PP</sub> <sup>(1)</sup>	A <sub>0</sub>	A <sub>9</sub>	CE #	OE #	WE #	DQ <sub>0</sub> –DQ <sub>7</sub>
READ-ONLY	Read	V <sub>PPL</sub>	A <sub>0</sub>	A <sub>9</sub>	V <sub>IL</sub>	V <sub>IL</sub>	V <sub>IH</sub>	Data Out
	Output Disable	V <sub>PPL</sub>	X	X	V <sub>IL</sub>	V <sub>IH</sub>	V <sub>IH</sub>	Tri-State
	Standby	V <sub>PPL</sub>	X	X	V <sub>IH</sub>	X	X	Tri-State
	Intelligent Identifier (Mfr) <sup>(2)</sup>	V <sub>PPL</sub>	V <sub>IL</sub>	V <sub>ID</sub> <sup>(3)</sup>	V <sub>IL</sub>	V <sub>IL</sub>	V <sub>IH</sub>	Data = 89H
	Intelligent Identifier (Device) <sup>(2)</sup>	V <sub>PPL</sub>	V <sub>IH</sub>	V <sub>ID</sub> <sup>(3)</sup>	V <sub>IL</sub>	V <sub>IL</sub>	V <sub>IH</sub>	Data = B4H
READ/WRITE	Read	V <sub>PPH</sub>	A <sub>0</sub>	A <sub>9</sub>	V <sub>IL</sub>	V <sub>IL</sub>	V <sub>IH</sub>	Data Out <sup>(4)</sup>
	Output Disable	V <sub>PPH</sub>	X	X	V <sub>IL</sub>	V <sub>IH</sub>	V <sub>IH</sub>	Tri-State
	Standby <sup>(5)</sup>	V <sub>PPH</sub>	X	X	V <sub>IH</sub>	X	X	Tri-State
	Write	V <sub>PPH</sub>	A <sub>0</sub>	A <sub>9</sub>	V <sub>IL</sub>	V <sub>IH</sub>	V <sub>IL</sub>	Data In <sup>(6)</sup>

**NOTES:**

1. Refer to DC Characteristics. When V<sub>PP</sub> = V<sub>PPL</sub> memory contents can be read but not written or erased.
2. Manufacturer and device codes may also be accessed via a command register write sequence. Refer to Table 3. All other addresses low.
3. V<sub>ID</sub> is the Intelligent Identifier high voltage. Refer to DC Characteristics.
4. Read operations with V<sub>PP</sub> = V<sub>PPH</sub> may access array data or the Intelligent Identifier codes.
5. With V<sub>PP</sub> at high voltage, the standby current equals I<sub>CC</sub> + I<sub>PP</sub> (standby).
6. Refer to Table 3 for valid Data-In during a write operation.
7. X can be V<sub>IL</sub> or V<sub>IH</sub>.

tents of the register default to the read command, making the 28F010 a read-only memory. In this mode, the memory contents cannot be altered.

Or, the system designer may choose to “hardwire” V<sub>PP</sub>, making the high voltage supply constantly available. In this case, all Command Register functions are inhibited whenever V<sub>CC</sub> is below the write lockout voltage V<sub>LKO</sub>. (See Power Up/Down Protection) The 28F010 is designed to accommodate either design practice, and to encourage optimization of the processor-memory interface.

The two-step program/erase write sequence to the Command Register provides additional software write protections.

**BUS OPERATIONS**
**Read**

The 28F010 has two control functions, both of which must be logically active, to obtain data at the outputs. Chip-Enable (CE #) is the power control and should be used for device selection. Output-Enable (OE #) is the output control and should be used to gate data from the output pins, independent of device selection. Refer to AC read timing waveforms.

When V<sub>PP</sub> is high (V<sub>PPH</sub>), the read operation can be used to access array data, to output the Intelligent Identifier codes, and to access data for program/

erase verification. When V<sub>PP</sub> is low (V<sub>PPL</sub>), the read operation can **only** access the array data.

**Output Disable**

With OE # at a logic-high level (V<sub>IH</sub>), output from the device is disabled. Output pins are placed in a high-impedance state.

**Standby**

With CE # at a logic-high level, the standby operation disables most of the 28F010’s circuitry and substantially reduces device power consumption. The outputs are placed in a high-impedance state, independent of the OE # signal. If the 28F010 is deselected during erasure, programming, or program/erase verification, the device draws active current until the operation is terminated.

**Intelligent Identifier Operation**

The Intelligent Identifier operation outputs the manufacturer code (89H) and device code (B4H). Programming equipment automatically matches the device with its proper erase and programming algorithms.

With CE# and OE# at a logic low level, raising A9 to high voltage V<sub>ID</sub> (see DC Characteristics) activates the operation. Data read from locations 0000H and 0001H represent the manufacturer's code and the device code, respectively.

The manufacturer- and device-codes can also be read via the command register, for instances where the 28F010 is erased and reprogrammed in the target system. Following a write of 90H to the command register, a read from address location 0000H outputs the manufacturer code (89H). A read from address 0001H outputs the device code (B4H).

### Write

Device erasure and programming are accomplished via the command register, when high voltage is applied to the V<sub>PP</sub> pin. The contents of the register serve as input to the internal state-machine. The state-machine outputs dictate the function of the device.

The command register itself does not occupy an addressable memory location. The register is a latch

used to store the command, along with address and data information needed to execute the command.

The command register is written by bringing WE# to a logic-low level (V<sub>IL</sub>), while CE# is low. Addresses are latched on the falling edge of WE#, while data is latched on the rising edge of the WE# pulse. Standard microprocessor write timings are used.

Refer to AC Write Characteristics and the Erase/Programming Waveforms for specific timing parameters.

### COMMAND DEFINITIONS

When low voltage is applied to the V<sub>PP</sub> pin, the contents of the command register default to 00H, enabling read-only operations.

Placing high voltage on the V<sub>PP</sub> pin enables read/write operations. Device operations are selected by writing specific data patterns into the command register. Table 3 defines these 28F010 register commands.

**Table 3. Command Definitions**

Command	Bus Cycles Req'd	First Bus Cycle			Second Bus Cycle		
		Operation(1)	Address(2)	Data(3)	Operation(1)	Address(2)	Data(3)
Read Memory	1	Write	X	00H			
Read Intelligent Identifier Codes(4)	3	Write	IA	90H	Read	IA	ID
Set-up Erase/Erase(5)	2	Write	X	20H	Write	X	20H
Erase Verify(5)	2	Write	EA	A0H	Read	X	EVD
Set-up Program/Program(6)	2	Write	X	40H	Write	PA	PD
Program Verify(6)	2	Write	X	C0H	Read	X	PVD
Reset(7)	2	Write	X	FFH	Write	X	FFH

#### NOTES:

- Bus operations are defined in Table 2.
- IA = Identifier address: 00H for manufacturer code, 01H for device code.  
EA = Erase Address: Address of memory location to be read during erase verify.  
PA = Program Address: Address of memory location to be programmed.  
Addresses are latched on the falling edge of the WE# pulse.
- ID = Identifier Data: Data read from location IA during device identification (Mfr = 89H, Device = B4H).  
EVD = Erase Verify Data: Data read from location EA during erase verify.  
PD = Program Data: Data to be programmed at location PA. Data is latched on the rising edge of WE#.  
PVD = Program Verify Data: Data read from location PA during program verify. PA is latched on the Program command.
- Following the Read intelligent ID command, two read operations access manufacturer and device codes.
- Figure 6 illustrates the Quick Erase Algorithm.
- Figure 5 illustrates the Quick Pulse Programming Algorithm.
- The second bus cycle must be followed by the desired command register write.



### Read Command

While  $V_{PP}$  is high, for erasure and programming, memory contents can be accessed via the read command. The read operation is initiated by writing 00H into the command register. Microprocessor read cycles retrieve array data. The device remains enabled for reads until the command register contents are altered.

The default contents of the register upon  $V_{PP}$  power-up is 00H. This default value ensures that no spurious alteration of memory contents occurs during the  $V_{PP}$  power transition. Where the  $V_{PP}$  supply is hard-wired to the 28F010, the device powers-up and remains enabled for reads until the command-register contents are changed. Refer to the AC Read Characteristics and Waveforms for specific timing parameters.

### Intelligent Identifier Command

Flash memories are intended for use in applications where the local CPU alters memory contents. As such, manufacturer- and device-codes must be accessible while the device resides in the target system. PROM programmers typically access signature codes by raising A9 to a high voltage. However, multiplexing high voltage onto address lines is not a desired system-design practice.

The 28F010 contains an Intelligent Identifier operation to supplement traditional PROM-programming methodology. The operation is initiated by writing 90H into the command register. Following the command write, a read cycle from address 0000H retrieves the manufacturer code of 89H. A read cycle from address 0001H returns the device code of B4H. To terminate the operation, it is necessary to write another valid command into the register.

### Set-up Erase/Erase Commands

Set-up Erase is a command-only operation that stages the device for electrical erasure of all bytes in the array. The set-up erase operation is performed by writing 20H to the command register.

To commence chip-erasure, the erase command (20H) must again be written to the register. The erase operation begins with the rising edge of the WE# pulse and terminates with the rising edge of the next WE# pulse (i.e., Erase-Verify Command).

This two-step sequence of set-up followed by execution ensures that memory contents are not accidentally erased. Also, chip-erasure can only occur when high voltage is applied to the  $V_{PP}$  pin. In the absence

of this high voltage, memory contents are protected against erasure. Refer to AC Erase Characteristics and Waveforms for specific timing parameters.

### Erase-Verify Command

The erase command erases all bytes of the array in parallel. After each erase operation, all bytes must be verified. The erase verify operation is initiated by writing A0H into the command register. The address for the byte to be verified must be supplied as it is latched on the falling edge of the WE# pulse. The register write terminates the erase operation with the rising edge of its WE# pulse.

The 28F010 applies an internally-generated margin voltage to the addressed byte. Reading FFH from the addressed byte indicates that all bits in the byte are erased.

The erase-verify command must be written to the command register prior to each byte verification to latch its address. The process continues for each byte in the array until a byte does not return FFH data, or the last address is accessed.

In the case where the data read is not FFH, another erase operation is performed. (Refer to Set-up Erase/Erase). Verification then resumes from the address of the last-verified byte. Once all bytes in the array have been verified, the erase step is complete. The device can be programmed. At this point, the verify operation is terminated by writing a valid command (e.g. Program Set-up) to the command register. Figure 6, the Quick Erase algorithm, illustrates how commands and bus operations are combined to perform electrical erasure of the 28F010. Refer to AC Erase Characteristics and Waveforms for specific timing parameters.

### Set-up Program/Program Commands

Set-up program is a command-only operation that stages the device for byte programming. Writing 40H into the command register performs the set-up operation.

Once the program set-up operation is performed, the next WE# pulse causes a transition to an active programming operation. Addresses are internally latched on the falling edge of the WE# pulse. Data is internally latched on the rising edge of the WE# pulse. The rising edge of WE# also begins the programming operation. The programming operation terminates with the next rising edge of WE#, used to write the program-verify command. Refer to AC Programming Characteristics and Waveforms for specific timing parameters.

### Program-Verify Command

The 28F010 is programmed on a byte-by-byte basis. Byte programming may occur sequentially or at random. Following each programming operation, the byte just programmed must be verified.

The program-verify operation is initiated by writing COH into the command register. The register write terminates the programming operation with the rising edge of its WE# pulse. The program-verify operation stages the device for verification of the byte last programmed. No new address information is latched.

The 28F010 applies an internally-generated margin voltage to the byte. A microprocessor read cycle outputs the data. A successful comparison between the programmed byte and true data means that the byte is successfully programmed. Programming then proceeds to the next desired byte location. Figure 5, the 28F010 Quick Pulse Programming algorithm, illustrates how commands are combined with bus operations to perform byte programming. Refer to AC Programming Characteristics and Waveforms for specific timing parameters.

### Reset Command

A reset command is provided as a means to safely abort the erase- or program-command sequences. Following either set-up command (erase or program) with two consecutive writes of FFH will safely abort the operation. Memory contents will not be altered. A valid command must then be written to place the device in the desired state.

### EXTENDED ERASE/PROGRAM CYCLING

EEPROM cycling failures have always concerned users. The high electrical field required by thin oxide EEPROMs for tunneling can literally tear apart the oxide at defect regions. To combat this, some suppliers have implemented redundancy schemes, reducing cycling failures to insignificant levels. However, redundancy requires that cell size be doubled—an expensive solution.

Intel has designed extended cycling capability into its ETOX flash memory technology. Resulting improvements in cycling reliability come without increasing memory cell size or complexity. First, an advanced tunnel oxide increases the charge carrying ability ten-fold. Second, the oxide area per cell subjected to the tunneling electric field is one-tenth that of common EEPROMs, minimizing the probability of oxide defects in the region. Finally, the peak electric field during erasure is approximately

2 MV/cm lower than EEPROM. The lower electric field greatly reduces oxide stress and the probability of failure.

The 28F010 is capable of 100,000 program/erase cycles. The device is programmed and erased using Intel's Quick Pulse Programming and Quick Erase algorithms. Intel's algorithmic approach uses a series of operations (pulses), along with byte verification, to completely and reliably erase and program the device.

For further information, see Reliability Report RR-60.

### QUICK PULSE PROGRAMMING ALGORITHM

The Quick Pulse Programming algorithm uses programming operations of 10  $\mu$ s duration. Each operation is followed by a byte verification to determine when the addressed byte has been successfully programmed. The algorithm allows for up to 25 programming operations per byte, although most bytes verify on the first or second operation. The entire sequence of programming and byte verification is performed with  $V_{PP}$  at high voltage. Figure 5 illustrates the Quick Pulse Programming algorithm.

### QUICK ERASE ALGORITHM

Intel's Quick Erase algorithm yields fast and reliable electrical erasure of memory contents. The algorithm employs a closed-loop flow, similar to the Quick Pulse Programming algorithm, to simultaneously remove charge from all bits in the array.

Erase begins with a read of memory contents. The 28F010 is erased when shipped from the factory. Reading FFH data from the device would immediately be followed by device programming.

For devices being erased and reprogrammed, uniform and reliable erasure is ensured by first programming all bits in the device to their charged state (Data = 00H). This is accomplished, using the Quick Pulse Programming algorithm, in approximately two seconds.

Erase execution then continues with an initial erase operation. Erase verification (data = FFH) begins at address 0000H and continues through the array to the last address, or until data other than FFH is encountered. With each erase operation, an increasing number of bytes verify to the erased state. Erase efficiency may be improved by storing the address of the last byte verified in a register. Following the next erase operation, verification starts at that stored address location. Erasure typically occurs in one second. Figure 6 illustrates the Quick Erase algorithm.



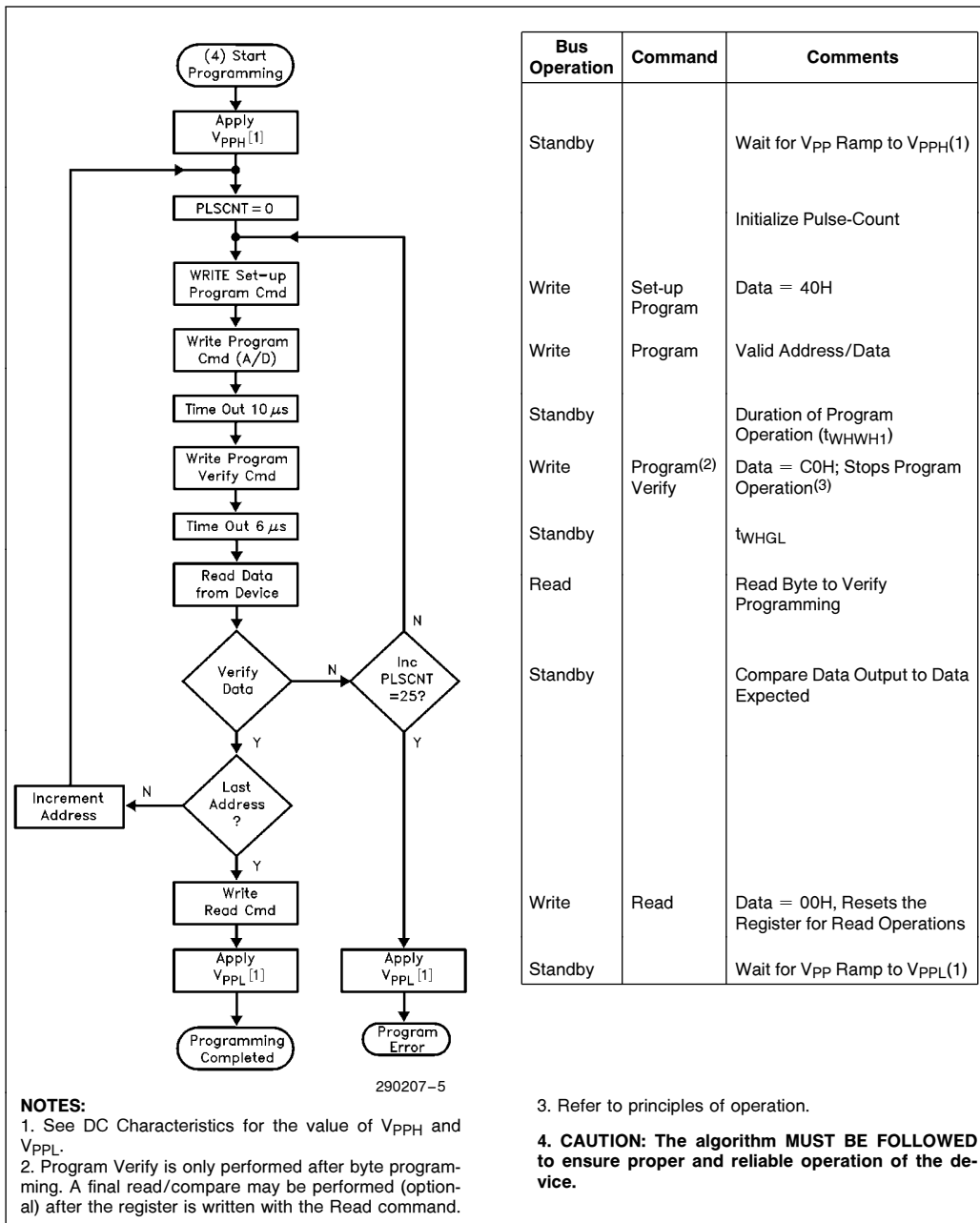

Bus Operation	Command	Comments
Standby		Wait for V <sub>PP</sub> Ramp to V <sub>PPH</sub> (1)
		Initialize Pulse-Count
Write	Set-up Program	Data = 40H
Write	Program	Valid Address/Data
Standby		Duration of Program Operation (t <sub>WHWH1</sub> )
Write	Program <sup>(2)</sup> Verify	Data = C0H; Stops Program Operation <sup>(3)</sup>
Standby		t <sub>WHGL</sub>
Read		Read Byte to Verify Programming
Standby		Compare Data Output to Data Expected
Write	Read	Data = 00H, Resets the Register for Read Operations
Standby		Wait for V <sub>PP</sub> Ramp to V <sub>PLL</sub> (1)

**NOTES:**  
 1. See DC Characteristics for the value of V<sub>PPH</sub> and V<sub>PLL</sub>.  
 2. Program Verify is only performed after byte programming. A final read/compare may be performed (optional) after the register is written with the Read command.

3. Refer to principles of operation.

**4. CAUTION: The algorithm MUST BE FOLLOWED to ensure proper and reliable operation of the device.**

Figure 5. 28F010 Quick Pulse Programming Algorithm

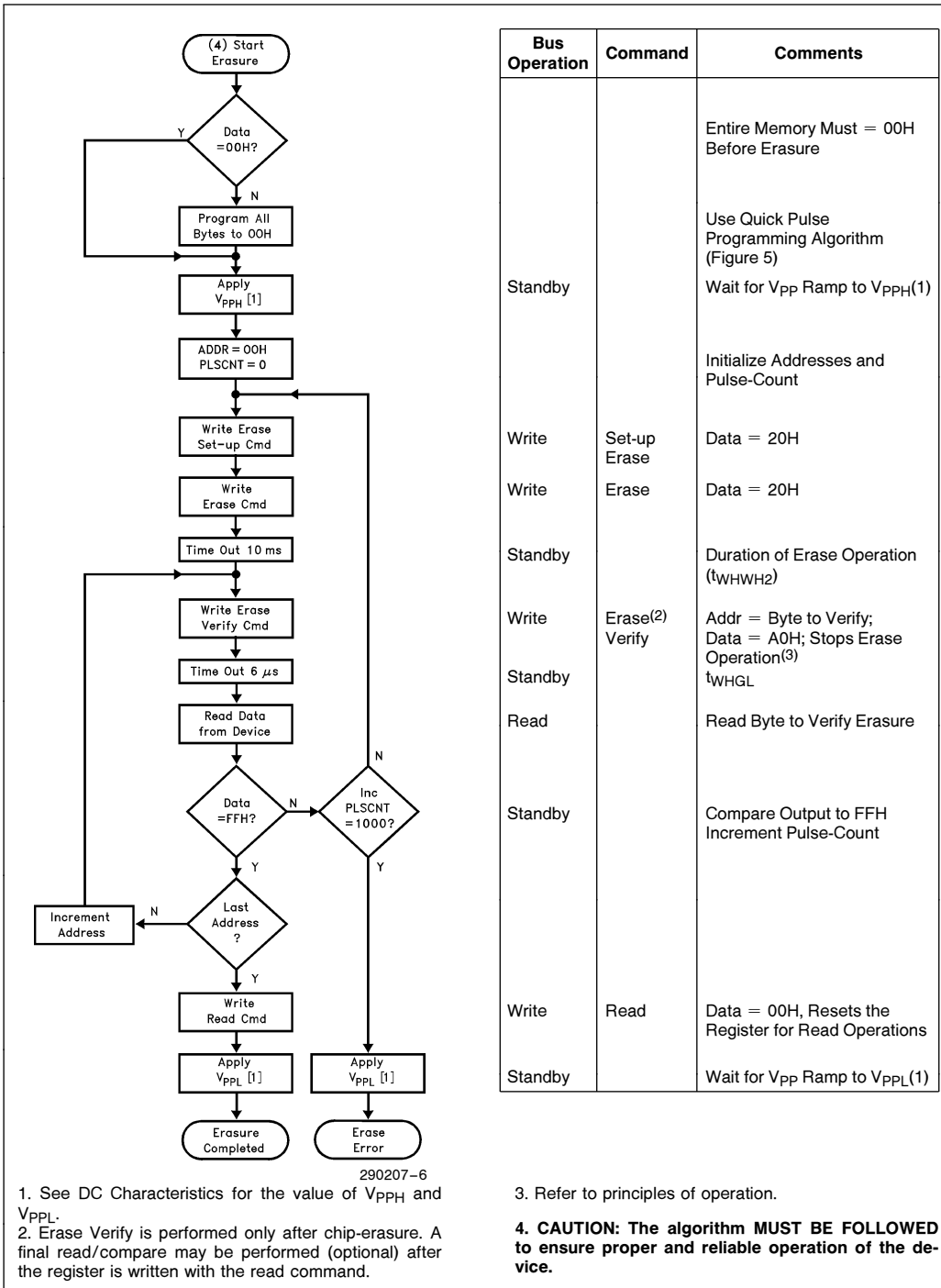

Figure 6. 28F010 Quick Erase Algorithm

## DESIGN CONSIDERATIONS

### Two-Line Output Control

Flash-memories are often used in larger memory arrays. Intel provides two read-control inputs to accommodate multiple memory connections. Two-line control provides for:

- a. the lowest possible memory power dissipation and,
- b. complete assurance that output bus contention will not occur.

To efficiently use these two control inputs, an address-decoder output should drive chip-enable, while the system's read signal controls all flash-memories and other parallel memories. This assures that only enabled memory devices have active outputs, while deselected devices maintain the low power standby condition.

### Power Supply Decoupling

Flash-memory power-switching characteristics require careful device decoupling. System designers are interested in three supply current ( $I_{CC}$ ) issues—standby, active, and transient current peaks produced by falling and rising edges of chip-enable. The capacitive and inductive loads on the device outputs determine the magnitudes of these peaks.

Two-line control and proper decoupling capacitor selection will suppress transient voltage peaks. Each device should have a 0.1  $\mu$ F ceramic capacitor connected between  $V_{CC}$  and  $V_{SS}$ , and between  $V_{PP}$  and  $V_{SS}$ .

Place the high-frequency, low-inherent-inductance capacitors as close as possible to the devices. Also, for every eight devices, a 4.7  $\mu$ F electrolytic capacitor should be placed at the array's power supply connection, between  $V_{CC}$  and  $V_{SS}$ . The bulk capacitor will overcome voltage slumps caused by printed-

circuit-board trace inductance, and will supply charge to the smaller capacitors as needed.

### $V_{PP}$ Trace on Printed Circuit Boards

Programming flash-memories, while they reside in the target system, requires that the printed circuit board designer pay attention to the  $V_{PP}$  power supply trace. The  $V_{PP}$  pin supplies the memory cell current for programming. Use similar trace widths and layout considerations given the  $V_{CC}$  power bus. Adequate  $V_{PP}$  supply traces and decoupling will decrease  $V_{PP}$  voltage spikes and overshoots.

### Power Up/Down Protection

The 28F010 is designed to offer protection against accidental erasure or programming during power transitions. Upon power-up, the 28F010 is indifferent as to which power supply,  $V_{PP}$  or  $V_{CC}$ , powers up first. Power supply sequencing is not required. Internal circuitry in the 28F010 ensures that the command register is reset to the read mode on power up.

A system designer must guard against active writes for  $V_{CC}$  voltages above  $V_{LKO}$  when  $V_{PP}$  is active. Since both  $WE\#$  and  $CE\#$  must be low for a command write, driving either to  $V_{IH}$  will inhibit writes. The control register architecture provides an added level of protection since alteration of memory contents only occurs after successful completion of the two-step command sequences.

### 28F010 Power Dissipation

When designing portable systems, designers must consider battery power consumption not only during device operation, but also for data retention during system idle time. Flash nonvolatility increases the usable battery life of your system because the 28F010 does not consume any power to retain code or data when the system is off. Table 4 illustrates the power dissipated when updating the 28F010.

Table 4. 28F010 Typical Update Power Dissipation<sup>(4)</sup>

Operation	Notes	Power Dissipation (Watt-Seconds)
Array Program/Program Verify	1	0.171
Array Erase/Erase Verify	2	0.136
One Complete Cycle	3	0.478

**NOTES:**

1. Formula to calculate typical Program/Program Verify Power = [ $V_{PP} \times \# \text{ Bytes} \times \text{typical } \# \text{ Prog Pulses} (t_{WHWH1} \times I_{PP2} \text{ typical} + t_{WHGL} \times I_{PP4} \text{ typical})$ ] + [ $V_{CC} \times \# \text{ Bytes} \times \text{typical } \# \text{ Prog Pulses} (t_{WHWH1} \times I_{CC2} \text{ typical} + t_{WHGL} \times I_{CC4} \text{ typical})$ ].
2. Formula to calculate typical Erase/Erase Verify Power = [ $V_{PP} (V_{PP3} \text{ typical} \times t_{ERASE} \text{ typical} + I_{PP5} \text{ typical} \times t_{WHGL} \times \# \text{ Bytes})$ ] + [ $V_{CC} (I_{CC3} \text{ typical} \times t_{ERASE} \text{ typical} + I_{CC5} \text{ typical} \times t_{WHGL} \times \# \text{ Bytes})$ ].
3. One Complete Cycle = Array Preprogram + Array Erase + Program.
4. "Typicals" are not guaranteed, but based on a limited number of samples from production lots.



### ABSOLUTE MAXIMUM RATINGS\*

Operating Temperature	
During Read	.....0°C to +70°C(1)
During Erase/Program	.....0°C to +70°C(1)
Operating Temperature	
During Read	.....–40°C to +85°C(2)
During Erase/Program	.....–40°C to +85°C(2)
Temperature Under Bias	.....–10°C to +80°C(1)
Temperature Under Bias	.....–50°C to +95°C(2)
Storage Temperature	.....–65°C to +125°C
Voltage on Any Pin with	
Respect to Ground	.....–2.0V to +7.0V(3)
Voltage on Pin A <sub>9</sub> with	
Respect to Ground	.....–2.0V to +13.5V(3, 4)
V <sub>PP</sub> Supply Voltage with	
Respect to Ground	
During Erase/Program	....–2.0V to +14.0V(3, 4)
V <sub>CC</sub> Supply Voltage with	
Respect to Ground	.....–2.0V to +7.0V(3)
Output Short Circuit Current	.....100 mA(5)

NOTICE: This is a production data sheet. The specifications are subject to change without notice.

*\*WARNING: Stressing the device beyond the “Absolute Maximum Ratings” may cause permanent damage. These are stress ratings only. Operation beyond the “Operating Conditions” is not recommended and extended exposure beyond the “Operating Conditions” may affect device reliability.*

### OPERATING CONDITIONS

Symbol	Parameter	Limits		Unit
		Min	Max	
T <sub>A</sub>	Operating Temperature(1)	0	70	°C
T <sub>A</sub>	Operating Temperature(2)	–40	+85	°C
V <sub>CC</sub>	V <sub>CC</sub> Supply Voltage (10%)(6)	4.50	5.50	V
V <sub>CC</sub>	V <sub>CC</sub> Supply Voltage (5%)(7)	4.75	5.25	V

#### NOTES:

1. Operating Temperature is for commercial product as defined by this specification.
2. Operating Temperature is for extended temperature products as defined by this specification.
3. Minimum DC input voltage is –0.5V. During transitions, inputs may undershoot to –2.0V for periods less than 20 ns. Maximum DC voltage on output pins is V<sub>CC</sub> + 0.5V, which may overshoot to V<sub>CC</sub> + 2.0V for periods less than 20 ns.
4. Maximum DC voltage on A<sub>9</sub> or V<sub>PP</sub> may overshoot to +14.0V for periods less than 20 ns.
5. Output shorted for no more than one second. No more than one output shorted at a time.
6. See High Speed AC Input/Output reference Waveforms and High Speed AC Testing Load Circuits for testing characteristics.
7. See AC Input/Output reference Waveforms and AC Testing Load Circuits for testing characteristics.

### DC CHARACTERISTICS—TTL/NMOS COMPATIBLE—Commercial Products

Symbol	Parameter	Notes	Limits			Unit	Test Conditions
			Min	Typical(4)	Max		
I <sub>LI</sub>	Input Leakage Current	1			±1.0	μA	V <sub>CC</sub> = V <sub>CC</sub> Max V <sub>IN</sub> = V <sub>CC</sub> or V <sub>SS</sub>
I <sub>LO</sub>	Output Leakage Current	1			±10	μA	V <sub>CC</sub> = V <sub>CC</sub> Max V <sub>OUT</sub> = V <sub>CC</sub> or V <sub>SS</sub>
I <sub>CCS</sub>	V <sub>CC</sub> Standby Current	1		0.3	1.0	mA	V <sub>CC</sub> = V <sub>CC</sub> Max CE# = V <sub>IH</sub>
I <sub>CC1</sub>	V <sub>CC</sub> Active Read Current	1		10	30	mA	V <sub>CC</sub> = V <sub>CC</sub> Max, CE# = V <sub>IL</sub> f = 6 MHz, I <sub>OUT</sub> = 0 mA

**DC CHARACTERISTICS—TTL/NMOS COMPATIBLE—Commercial Products**

(Continued)

Symbol	Parameter	Notes	Limits			Unit	Test Conditions
			Min	Typical(4)	Max		
I <sub>CC2</sub>	V <sub>CC</sub> Programming Current	1, 2		1.0	10	mA	Programming in Progress
I <sub>CC3</sub>	V <sub>CC</sub> Erase Current	1, 2		5.0	15	mA	Erasure in Progress
I <sub>CC4</sub>	V <sub>CC</sub> Program Verify Current	1, 2		5.0	15	mA	V <sub>PP</sub> = V <sub>PPH</sub> Program Verify in Progress
I <sub>CC5</sub>	V <sub>CC</sub> Erase Verify Current	1, 2		5.0	15	mA	V <sub>PP</sub> = V <sub>PPH</sub> Erase Verify in Progress
I <sub>PPS</sub>	V <sub>PP</sub> Leakage Current	1			± 10	μA	V <sub>PP</sub> ≤ V <sub>CC</sub>
I <sub>PP1</sub>	V <sub>PP</sub> Read Current or Standby Current	1		90	200	μA	V <sub>PP</sub> > V <sub>CC</sub>
					± 10.0		V <sub>PP</sub> ≤ V <sub>CC</sub>
I <sub>PP2</sub>	V <sub>PP</sub> Programming Current	1, 2		8.0	30	mA	V <sub>PP</sub> = V <sub>PPH</sub> Programming in Progress
I <sub>PP3</sub>	V <sub>PP</sub> Erase Current	1, 2		6.0	30	mA	V <sub>PP</sub> = V <sub>PPH</sub> Erasure in Progress
I <sub>PP4</sub>	V <sub>PP</sub> Program Verify Current	1, 2		2.0	5.0	mA	V <sub>PP</sub> = V <sub>PPH</sub> Program Verify in Progress
I <sub>PP5</sub>	V <sub>PP</sub> Erase Verify Current	1, 2		2.0	5.0	mA	V <sub>PP</sub> = V <sub>PPH</sub> Erase Verify in Progress
V <sub>IL</sub>	Input Low Voltage		-0.5		0.8	V	
V <sub>IH</sub>	Input High Voltage		2.0		V <sub>CC</sub> + 0.5	V	
V <sub>OL</sub>	Output Low Voltage				0.45	V	V <sub>CC</sub> = V <sub>CC</sub> Min I <sub>OL</sub> = 5.8 mA
V <sub>OH1</sub>	Output High Voltage		2.4			V	V <sub>CC</sub> = V <sub>CC</sub> Min I <sub>OH</sub> = -2.5 mA
V <sub>ID</sub>	A <sub>9</sub> Intelligent Identifier Voltage		11.50		13.00	V	
I <sub>ID</sub>	A <sub>9</sub> Intelligent Identifier Current	1, 2		90	200	μA	A <sub>9</sub> = V <sub>ID</sub>
V <sub>PP1</sub>	V <sub>PP</sub> during Read-Only Operations		0.00		6.5	V	<b>NOTE:</b> Erase/Program are Inhibited when V <sub>PP</sub> = V <sub>PP1</sub>
V <sub>PPH</sub>	V <sub>PP</sub> during Read/Write Operations		11.40		12.60	V	
V <sub>LKO</sub>	V <sub>CC</sub> Erase/Write Lock Voltage		2.5			V	

**DC CHARACTERISTICS—CMOS COMPATIBLE—Commercial Products**

Symbol	Parameter	Notes	Limits			Unit	Test Conditions
			Min	Typical(4)	Max		
I <sub>LI</sub>	Input Leakage Current	1			± 1.0	μA	V <sub>CC</sub> = V <sub>CC</sub> Max V <sub>IN</sub> = V <sub>CC</sub> or V <sub>SS</sub>
I <sub>LO</sub>	Output Leakage Current	1			± 10	μA	V <sub>CC</sub> = V <sub>CC</sub> Max V <sub>OUT</sub> = V <sub>CC</sub> or V <sub>SS</sub>
I <sub>CCS</sub>	V <sub>CC</sub> Standby Current	1		50	100	μA	V <sub>CC</sub> = V <sub>CC</sub> Max CE# = V <sub>CC</sub> ± 0.2V
I <sub>CC1</sub>	V <sub>CC</sub> Active Read Current	1		10	30	mA	V <sub>CC</sub> = V <sub>CC</sub> Max, CE# = V <sub>IL</sub> f = 6 MHz, I <sub>OUT</sub> = 0 mA

**DC CHARACTERISTICS—CMOS COMPATIBLE—Commercial Products** (Continued)

Symbol	Parameter	Notes	Limits			Unit	Test Conditions
			Min	Typical(4)	Max		
I <sub>CC2</sub>	V <sub>CC</sub> Programming Current	1, 2		1.0	10	mA	Programming in Progress
I <sub>CC3</sub>	V <sub>CC</sub> Erase Current	1, 2		5.0	15	mA	Erase in Progress
I <sub>CC4</sub>	V <sub>CC</sub> Program Verify Current	1, 2		5.0	15	mA	V <sub>PP</sub> = V <sub>PPH</sub> , Program Verify in Progress
I <sub>CC5</sub>	V <sub>CC</sub> Erase Verify Current	1, 2		5.0	15	mA	V <sub>PP</sub> = V <sub>PPH</sub> , Erase Verify in Progress
I <sub>PP5</sub>	V <sub>PP</sub> Leakage Current	1			± 10	μA	V <sub>PP</sub> ≤ V <sub>CC</sub>
I <sub>PP1</sub>	V <sub>PP</sub> Read Current, ID Current or Standby Current	1		90	200	μA	V <sub>PP</sub> > V <sub>CC</sub>
					± 10		V <sub>PP</sub> ≤ V <sub>CC</sub>
I <sub>PP2</sub>	V <sub>PP</sub> Programming Current	1, 2		8.0	30	mA	V <sub>PP</sub> = V <sub>PPH</sub> , Programming in Progress
I <sub>PP3</sub>	V <sub>PP</sub> Erase Current	1, 2		6.0	30	mA	V <sub>PP</sub> = V <sub>PPH</sub> , Erase in Progress
I <sub>PP4</sub>	V <sub>PP</sub> Program Verify Current	1, 2		2.0	5.0	mA	V <sub>PP</sub> = V <sub>PPH</sub> , Program Verify in Progress
I <sub>PP5</sub>	V <sub>PP</sub> Erase Verify Current	1, 2		2.0	5.0	mA	V <sub>PP</sub> = V <sub>PPH</sub> , Erase Verify in Progress
V <sub>IL</sub>	Input Low Voltage		-0.5		0.8	V	
V <sub>IH</sub>	Input High Voltage		0.7 V <sub>CC</sub>		V <sub>CC</sub> + 0.5	V	
V <sub>OL</sub>	Output Low Voltage				0.45	V	V <sub>CC</sub> = V <sub>CC</sub> Min I <sub>OL</sub> = 5.8 mA
V <sub>OH1</sub>	Output High Voltage		0.85 V <sub>CC</sub>			V	V <sub>CC</sub> = V <sub>CC</sub> Min, I <sub>OH</sub> = -2.5 mA
V <sub>OH2</sub>			V <sub>CC</sub> - 0.4				V <sub>CC</sub> = V <sub>CC</sub> Min, I <sub>OH</sub> = -100 μA
V <sub>ID</sub>	A <sub>9</sub> Intelligent Identifier Voltage		11.50		13.00	V	
I <sub>ID</sub>	A <sub>9</sub> Intelligent Identifier Current	1, 2		90	200	μA	A <sub>9</sub> = V <sub>ID</sub>
V <sub>PP_L</sub>	V <sub>PP</sub> during Read-Only Operations		0.00		6.5	V	<b>NOTE:</b> Erase/Programs are Inhibited when V <sub>PP</sub> = V <sub>PP_L</sub>
V <sub>PP_H</sub>	V <sub>PP</sub> during Read/Write Operations		11.40		12.60	V	
V <sub>LKO</sub>	V <sub>CC</sub> Erase/Write Lock Voltage		2.5			V	



**DC CHARACTERISTICS—TTL/NMOS COMPATIBLE—Extended Temperature Products**

Symbol	Parameter	Notes	Limits			Unit	Test Conditions
			Min	Typical(4)	Max		
I <sub>LI</sub>	Input Leakage Current	1			± 1.0	μA	V <sub>CC</sub> = V <sub>CC</sub> Max V <sub>IN</sub> = V <sub>CC</sub> or V <sub>SS</sub>
I <sub>LO</sub>	Output Leakage Current	1			± 10	μA	V <sub>CC</sub> = V <sub>CC</sub> Max V <sub>OUT</sub> = V <sub>CC</sub> or V <sub>SS</sub>
I <sub>CCS</sub>	V <sub>CC</sub> Standby Current	1		0.3	1.0	mA	V <sub>CC</sub> = V <sub>CC</sub> Max CE# = V <sub>IH</sub>
I <sub>CC1</sub>	V <sub>CC</sub> Active Read Current	1		10	30	mA	V <sub>CC</sub> = V <sub>CC</sub> Max, CE# = V <sub>IL</sub> f = 6 MHz, I <sub>OUT</sub> = 0 mA
I <sub>CC2</sub>	V <sub>CC</sub> Programming Current	1, 2		1.0	30	mA	Programming in Progress
I <sub>CC3</sub>	V <sub>CC</sub> Erase Current	1, 2		5.0	30	mA	Erase in Progress
I <sub>CC4</sub>	V <sub>CC</sub> Program Verify Current	1, 2		5.0	30	mA	V <sub>PP</sub> = V <sub>PPH</sub> Program Verify in Progress
I <sub>CC5</sub>	V <sub>CC</sub> Erase Verify Current	1, 2		5.0	30	mA	V <sub>PP</sub> = V <sub>PPH</sub> Erase Verify in Progress
I <sub>PPS</sub>	V <sub>PP</sub> Leakage Current	1			± 10	μA	V <sub>PP</sub> ≤ V <sub>CC</sub>
I <sub>PP1</sub>	V <sub>PP</sub> Read Current or Standby Current	1		90	200	μA	V <sub>PP</sub> > V <sub>CC</sub>
					± 10.0		V <sub>PP</sub> ≤ V <sub>CC</sub>
I <sub>PP2</sub>	V <sub>PP</sub> Programming Current	1, 2		8.0	30	mA	V <sub>PP</sub> = V <sub>PPH</sub> Programming in Progress
I <sub>PP3</sub>	V <sub>PP</sub> Erase Current	1, 2		6.0	30	mA	V <sub>PP</sub> = V <sub>PPH</sub> Erase in Progress
I <sub>PP4</sub>	V <sub>PP</sub> Program Verify Current	1, 2		2.0	5.0	mA	V <sub>PP</sub> = V <sub>PPH</sub> Program Verify in Progress
I <sub>PP5</sub>	V <sub>PP</sub> Erase Verify Current	1, 2		2.0	5.0	mA	V <sub>PP</sub> = V <sub>PPH</sub> Erase Verify in Progress
V <sub>IL</sub>	Input Low Voltage		-0.5		0.8	V	
V <sub>IH</sub>	Input High Voltage		2.0		V <sub>CC</sub> + 0.5	V	
V <sub>OL</sub>	Output Low Voltage				0.45	V	V <sub>CC</sub> = V <sub>CC</sub> Min I <sub>OL</sub> = 5.8 mA
V <sub>OH1</sub>	Output High Voltage		2.4			V	V <sub>CC</sub> = V <sub>CC</sub> Min I <sub>OH</sub> = -2.5 mA
V <sub>ID</sub>	A <sub>9</sub> Intelligent Identifier Voltage		11.50		13.00	V	
I <sub>ID</sub>	A <sub>9</sub> Intelligent Identifier Current	1, 2		90	500	μA	A <sub>9</sub> = V <sub>ID</sub>
V <sub>PPPL</sub>	V <sub>PP</sub> during Read-Only Operations		0.00		6.5	V	<b>NOTE:</b> Erase/Program are Inhibited when V <sub>PP</sub> = V <sub>PPPL</sub>
V <sub>PPH</sub>	V <sub>PP</sub> during Read/Write Operations		11.40		12.60	V	
V <sub>LKO</sub>	V <sub>CC</sub> Erase/Write Lock Voltage		2.5			V	

**DC CHARACTERISTICS—CMOS COMPATIBLE—Extended Temperature Products**

Symbol	Parameter	Notes	Limits			Unit	Test Conditions
			Min	Typical(4)	Max		
I <sub>LI</sub>	Input Leakage Current	1			± 1.0	μA	V <sub>CC</sub> = V <sub>CC</sub> Max V <sub>IN</sub> = V <sub>CC</sub> or V <sub>SS</sub>
I <sub>LO</sub>	Output Leakage Current	1			± 10	μA	V <sub>CC</sub> = V <sub>CC</sub> Max V <sub>OUT</sub> = V <sub>CC</sub> or V <sub>SS</sub>
I <sub>CCS</sub>	V <sub>CC</sub> Standby Current	1		50	100	μA	V <sub>CC</sub> = V <sub>CC</sub> Max CE# = V <sub>CC</sub> ± 0.2V
I <sub>CC1</sub>	V <sub>CC</sub> Active Read Current	1		10	30	mA	V <sub>CC</sub> = V <sub>CC</sub> Max, CE# = V <sub>IL</sub> f = 10 MHz, I <sub>OUT</sub> = 0 mA
I <sub>CC2</sub>	V <sub>CC</sub> Programming Current	1, 2		1.0	10	mA	Programming in Progress
I <sub>CC3</sub>	V <sub>CC</sub> Erase Current	1, 2		5.0	30	mA	Erase in Progress
I <sub>CC4</sub>	V <sub>CC</sub> Program Verify Current	1, 2		5.0	30	mA	V <sub>PP</sub> = V <sub>PPH</sub> Program Verify in Progress
I <sub>CC5</sub>	V <sub>CC</sub> Erase Verify Current	1, 2		5.0	30	mA	V <sub>PP</sub> = V <sub>PPH</sub> Erase Verify in Progress
I <sub>PPS</sub>	V <sub>PP</sub> Leakage Current	1			± 10	μA	V <sub>PP</sub> ≤ V <sub>CC</sub>
I <sub>PP1</sub>	V <sub>PP</sub> Read Current, ID Current or Standby Current	1		90	200	μA	V <sub>PP</sub> > V <sub>CC</sub>
					± 10		V <sub>PP</sub> ≤ V <sub>CC</sub>
I <sub>PP2</sub>	V <sub>PP</sub> Programming Current	1, 2		8.0	30	mA	V <sub>PP</sub> = V <sub>PPH</sub> Programming in Progress
I <sub>PP3</sub>	V <sub>PP</sub> Erase Current	1, 2		6.0	30	mA	V <sub>PP</sub> = V <sub>PPH</sub> Erase in Progress
I <sub>PP4</sub>	V <sub>PP</sub> Program Verify Current	1, 2		2.0	5.0	mA	V <sub>PP</sub> = V <sub>PPH</sub> Program Verify in Progress
I <sub>PP5</sub>	V <sub>PP</sub> Erase Verify Current	1, 2		2.0	5.0	mA	V <sub>PP</sub> = V <sub>PPH</sub> Erase Verify in Progress
V <sub>IL</sub>	Input Low Voltage		-0.5		0.8	V	
V <sub>IH</sub>	Input High Voltage		0.7 V <sub>CC</sub>		V <sub>CC</sub> + 0.5	V	
V <sub>OL</sub>	Output Low Voltage				0.45	V	V <sub>CC</sub> = V <sub>CC</sub> Min I <sub>OL</sub> = 5.8 mA
V <sub>OH1</sub>	Output High Voltage		0.85 V <sub>CC</sub>			V	V <sub>CC</sub> = V <sub>CC</sub> Min I <sub>OH</sub> = -2.5 mA
V <sub>OH2</sub>			V <sub>CC</sub> - 0.4				V <sub>CC</sub> = V <sub>CC</sub> Min I <sub>OH</sub> = -100 μA
V <sub>ID</sub>	A <sub>9</sub> Intelligent Identifier Voltage		11.50		13.00	V	
I <sub>ID</sub>	A <sub>9</sub> Intelligent Identifier Current	1, 2		90	500	μA	A <sub>9</sub> = V <sub>ID</sub>

**DC CHARACTERISTICS—CMOS COMPATIBLE—Extended Temperature Products** (Continued)

Symbol	Parameter	Notes	Limits			Unit	Test Conditions
			Min	Typical(4)	Max		
V <sub>PPL</sub>	V <sub>PP</sub> during Read-Only Operations		0.00		6.5	V	<b>NOTE:</b> Erase/Programs are Inhibited when V <sub>PP</sub> = V <sub>PPL</sub>
V <sub>PPH</sub>	V <sub>PP</sub> during Read/Write Operations		11.40		12.60	V	
V <sub>LKO</sub>	V <sub>CC</sub> Erase/Write Lock Voltage		2.5			V	

**CAPACITANCE** T<sub>A</sub> = 25°C, f = 1.0 MHz

Symbol	Parameter	Notes	Limits		Unit	Conditions
			Min	Max		
C <sub>IN</sub>	Address/Control Capacitance	3		8	pF	V <sub>IN</sub> = 0V
C <sub>OUT</sub>	Output Capacitance	3		12	pF	V <sub>OUT</sub> = 0V

**NOTES:**

1. All currents are in RMS unless otherwise noted. Typical values at V<sub>CC</sub> = 5.0V, V<sub>PP</sub> = 12.0V, T = 25°C. These currents are valid for all product versions (packages and speeds).
2. Not 100% tested: characterization data available.
3. Sampled, not 100% tested.
4. "Typicals" are not guaranteed, but based on a limited number of samples from production lots.



**AC TESTING INPUT/OUTPUT WAVEFORM(1)**

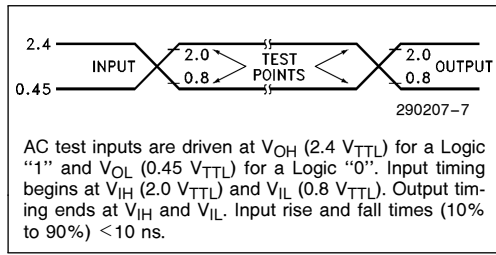

**HIGH SPEED AC TESTING INPUT/OUTPUT WAVEFORM(2)**

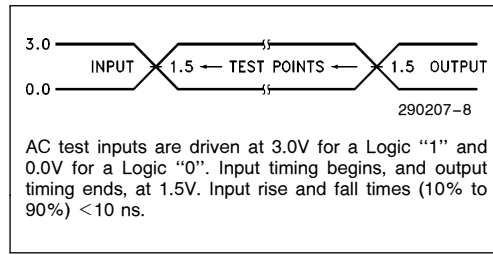

**AC TESTING LOAD CIRCUIT(1)**

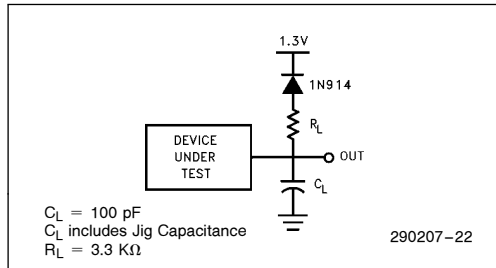

**HIGH SPEED AC TESTING LOAD CIRCUIT(2)**

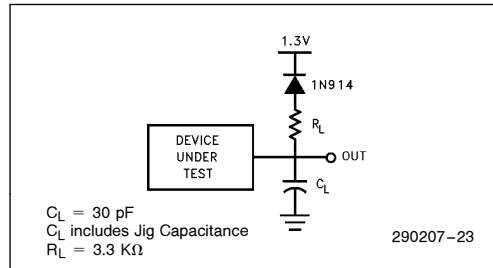

**AC TEST CONDITIONS(1)**

- Input Rise and Fall Times (10% to 90%) . . . . . 10 ns
- Input Pulse Levels . . . . . 0.45V and 2.4V
- Input Timing Reference Level . . . . . 0.8V and 2.0V
- Output Timing Reference Level . . . . . 0.8V and 2.0V
- Capacitive Load . . . . . 100 pF

**HIGH-SPEED AC TEST CONDITIONS(2)**

- Input Rise and Fall Times (10% to 90%) . . . . . 10 ns
- Input Pulse Levels . . . . . 0.0V and 3.0V
- Input Timing Reference Level . . . . . 1.5V
- Output Timing Reference Level . . . . . 1.5V
- Capacitive Load . . . . . 30 pF

**NOTES:**

1. Testing characteristics for 28F010-65 in standard configuration, and 28F010-90, 28F010-120, and 28F010-150.
2. Testing characteristics for 28F010-65 in high speed configuration.



**AC CHARACTERISTICS—Read Only Operations—Commercial and Extended Temperature Products**

Versions		V <sub>CC</sub> ± 5%		28F010-65(4)		28F010-65(5)		28F010-90(5)		28F010-120(5)		28F010-150(5)		Unit
		Symbol	Characteristic	Notes	Min	Max	Min	Max	Min	Max	Min	Max	Min	
t <sub>AVAV</sub> /t <sub>RC</sub>	Read Cycle Time		65		65	70		90		120		150		ns
t <sub>ELQV</sub> /t <sub>OE</sub>	CE # Access Time				65		70		90		120		150	ns
t <sub>AVQV</sub> /t <sub>ACC</sub>	Address Access Time				65		70		90		120		150	ns
t <sub>GLQV</sub> /t <sub>OE</sub>	OE # Access Time				25		28		35		50		55	ns
t <sub>ELOX</sub> /t <sub>LZ</sub>	CE # to Low Z		2, 3	0		0		0		0		0		ns
t <sub>EHQZ</sub>	Chip Disable to Output in High Z		2		35		40		45		55		55	ns
t <sub>GLOX</sub> /t <sub>OLZ</sub>	OE # to Output in Low Z		2, 3	0		0		0		0		0		ns
t <sub>GHQZ</sub> /t <sub>DF</sub>	Output Disable to Output in High Z		2		30		30		30		30		35	ns
t <sub>OH</sub>	Output Hold from Address, CE #, or OE # Change		1, 2	0		0		0		0		0		ns
t <sub>WHGL</sub>	Write Recovery Time before Read			6		6		6		6		6		μs

**NOTES:**

1. Whichever occurs first.
2. Sampled, not 100% tested.
3. Guaranteed by design.
4. See High Speed AC Input/Output reference Waveforms and High Speed AC Testing Load Circuits for testing characteristics.
5. See AC Input/Output reference Waveforms and AC Testing Load Circuits for testing characteristics.

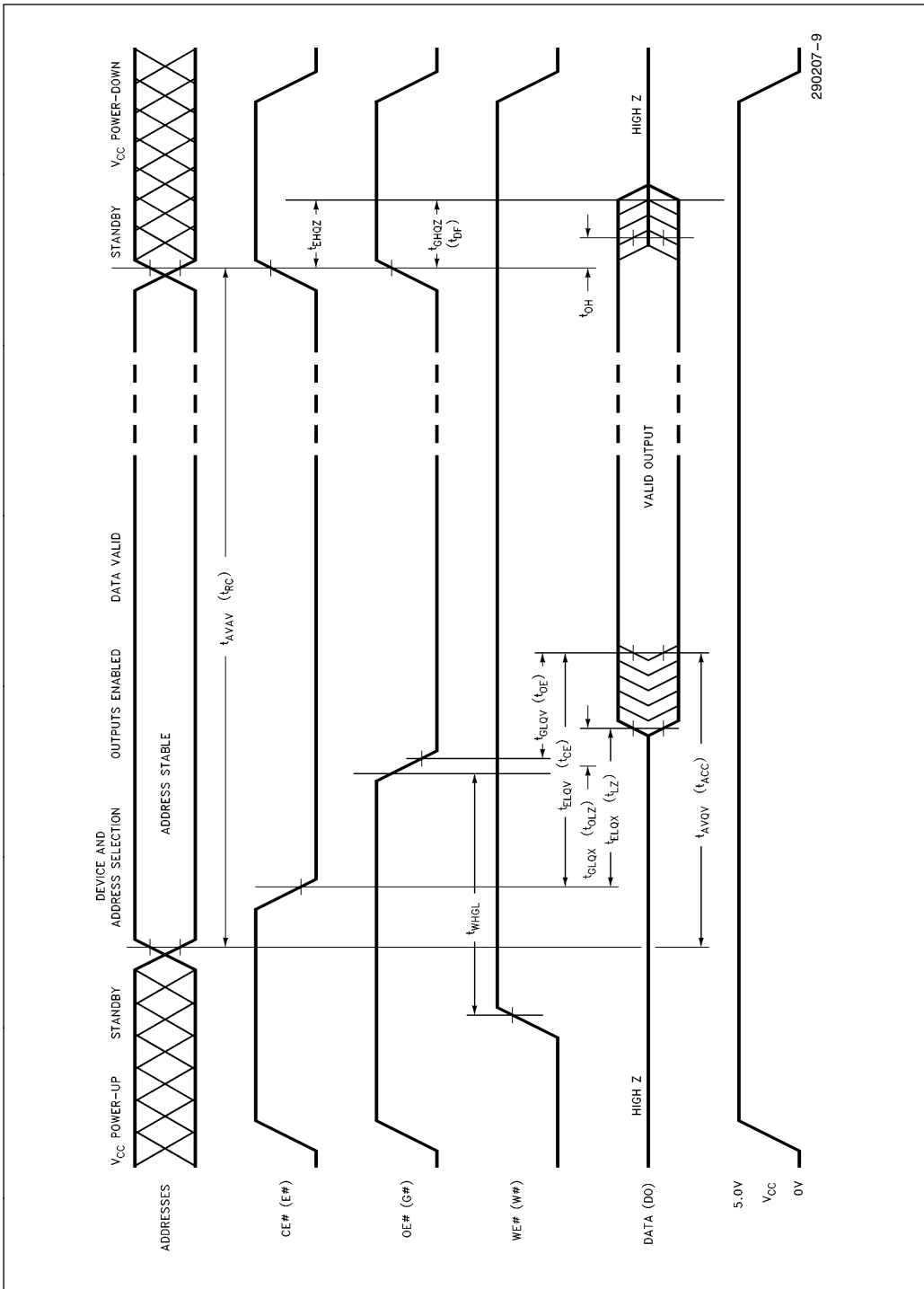

Figure 7. AC Waveforms for Read Operations

**AC CHARACTERISTICS—Write/Erase/Program Only Operations(1)—  
Commercial and Extended Temperature Products**

Versions		28F010-65(4)		28F010-65(5)		28F010-90(5)		28F010-120(5)		28F010-150(5)		Unit	
Symbol	Characteristic	Notes	Min	Max	Min	Max	Min	Max	Min	Max	Min	Max	
$t_{AVAV}/t_{WC}$	Write Cycle Time		65		70		90		120		150		ns
$t_{AVWL}/t_{AS}$	Address Set-Up Time		0		0		0		0		0		ns
$t_{WLAX}/t_{AH}$	Address Hold Time		40		40		40		40		40		ns
$t_{DWWH}/t_{DS}$	Data Set-Up Time	6	40		40		40		40		40		ns
$t_{WHDX}/t_{DH}$	Data Hold Time	6	10		10		10		10		10		ns
$t_{WHGL}$	Write Recovery Time before Read		6		6		6		6		6		$\mu$ s
$t_{GHWL}$	Read Recovery Time before Write	2	0		0		0		0		0		ns
$t_{ELWL}/t_{CS}$	Chip Enable Set-Up Time before Write		15		15		15		15		15		ns
$t_{WHEH}/t_{CH}$	Chip Enable Hold Time		0		0		0		0		0		ns
$t_{WLWH}/t_{WP}$	Write Pulse Width		40		40		40		60		60		ns
$t_{WHWL}/t_{WPH}$	Write Pulse Width High		20		20		20		20		20		ns
$t_{WHWH1}$	Duration of Programming Operation	3	10		10		10		10		10		$\mu$ s
$t_{WHWH2}$	Duration of Erase Operation	3	9.5		9.5		9.5		9.5		9.5		ms
$t_{YPEL}$	$V_{PP}$ Set-Up Time to Chip Enable Low	2	1		1		1		1		1		$\mu$ s

**NOTES:**

1. Read timing characteristics during read/write operations are the same as during read-only operations. Refer to AC Characteristics for Read-Only Operations.
2. Guaranteed by design.
3. The integrated stop timer terminates the programming/erase operations, thus eliminating the need for a maximum specification.
4. See High Speed AC Input/Output reference Waveforms and High Speed AC Testing Load Circuits for testing characteristics.
5. See AC Input/Output reference Waveforms and AC Testing Load Circuits for testing characteristics.
6. Minimum specification for Extended Temperature product.

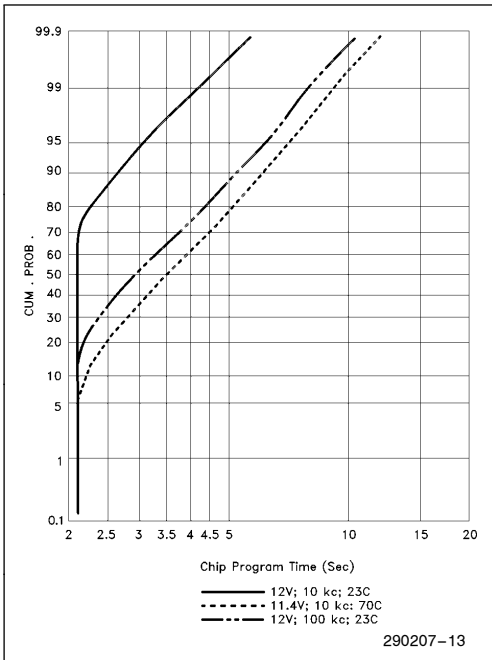

Figure 8. Typical Programming Capability

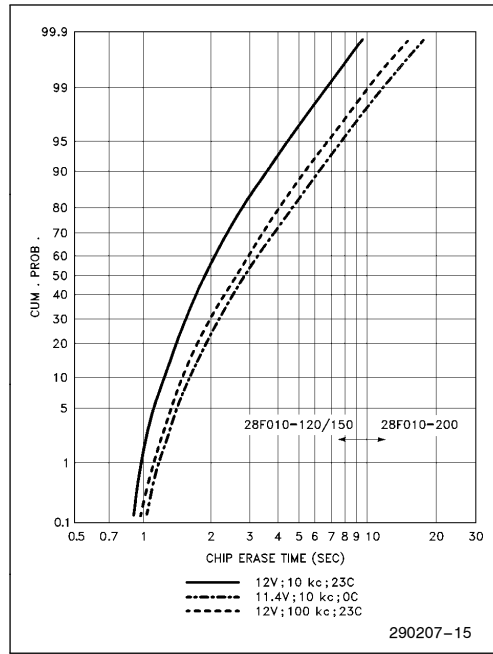

Figure 10. Typical Erase Capability

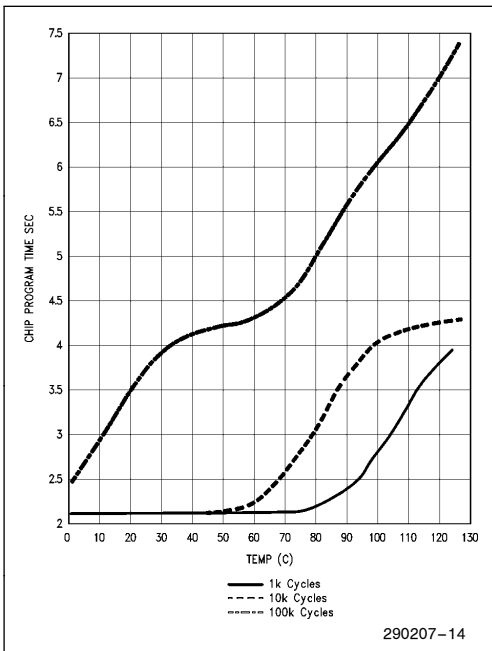

Figure 9. Typical Program Time at 12V

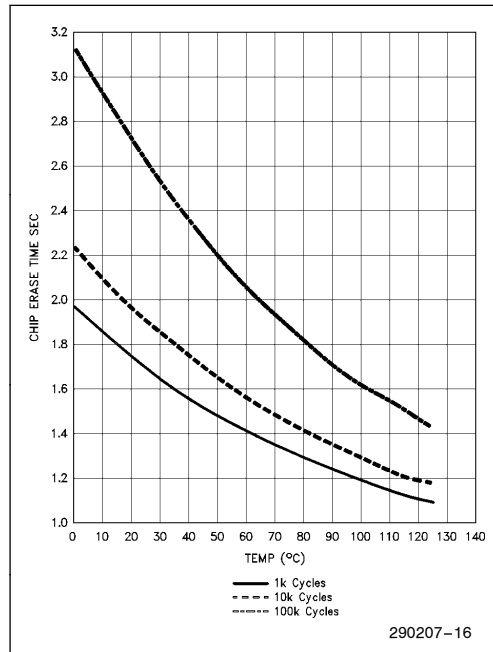
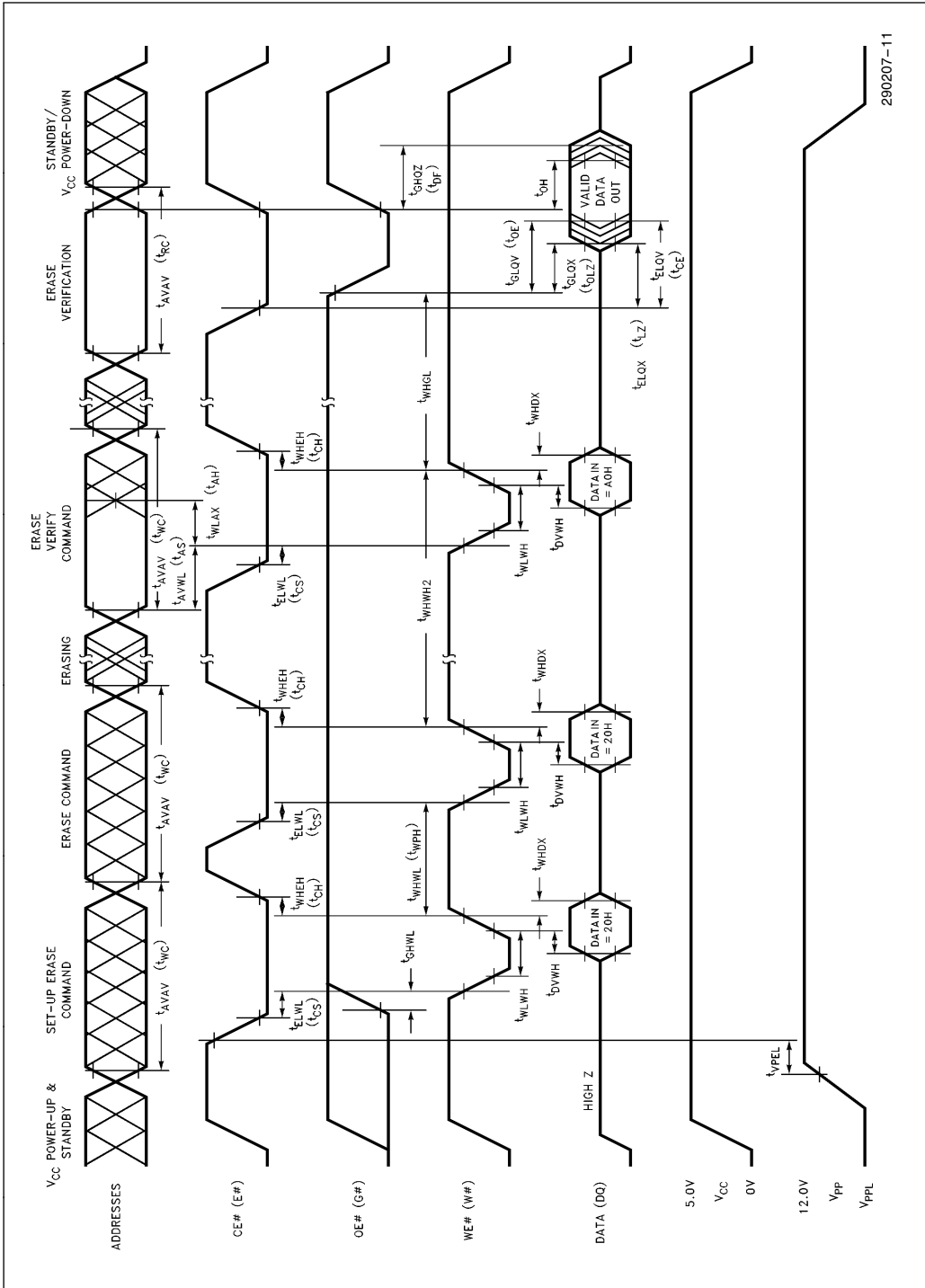

Figure 11. Typical Erase Time at 12V







290207-11

Figure 13. AC Waveforms for Erase Operations

**AC CHARACTERISTICS—Alternative CE #-Controlled Writes—Commercial and Extended Temperature**

Versions		V <sub>CC</sub> ± 5% V <sub>CC</sub> ± 10%	28F010-65(2,4)		28F010-65(5)		28F010-90(5)		28F010-120(5)		28F010-150(5)		Unit
			Symbol	Characteristic	Notes	Min	Max	Min	Max	Min	Max	Min	
t <sub>AVAV</sub>	Write Cycle Time		65	70	90	120	150					ns	
t <sub>AVEL</sub>	Address Set-Up Time		0	0	0	0	0					ns	
t <sub>ELAX</sub>	Address Hold Time		45	45	45	55	55					ns	
t <sub>DVEH</sub>	Data Set-Up Time	6	35	35	35	45	45					ns	
t <sub>EHDX</sub>	Data Hold Time	6	10	10	10	10	10					ns	
t <sub>EHGL</sub>	Write Recovery Time before Read		6	6	6	6	6					μs	
t <sub>GHWL</sub>	Read Recovery Time before Write	2	0	0	0	0	0					ns	
t <sub>WLEL</sub>	Write Enable Set-Up Time before Chip Enable		0	0	0	0	0					ns	
t <sub>EHWH</sub>	Write Enable Hold Time		0	0	0	0	0					ns	
t <sub>LELH</sub>	Write Pulse Width		45	45	45	70	70					ns	
t <sub>HELH</sub>	Write Pulse Width High		20	20	20	20	20					ns	
t <sub>EH1H</sub>	Duration of Programming Operation	3	10	10	10	10	10					μs	
t <sub>EH2H</sub>	Duration of Erase Operation	3	9.5	9.5	9.5	9.5	9.5					ms	
t <sub>PEL</sub>	V <sub>PP</sub> Set-Up Time to Chip Enable Low	2	1	1	1	1	1					μs	

**NOTE:**  
 1. Read timing characteristics during read/write operations are the same as during read-only operations. Refer to AC Characteristics for Read-Only Operations.  
 2. Guaranteed by design.  
 3. The integrated stop timer terminates the programming/erase operations, thus eliminating the need for a maximum specification.  
 4. See High Speed AC Input/Output reference Waveforms and High Speed AC Testing Load Circuits for testing characteristics.  
 5. See AC Input/Output reference Waveforms and AC Testing Load Circuits for testing characteristics.  
 6. Minimum specification for Extended Temperature product.

**ERASE AND PROGRAMMING PERFORMANCE**

Parameter	Notes	Min	Typical	Max	Unit
Chip Erase Time	1, 3, 4		1	10	Sec
Chip Program Time	1, 2, 4		2	12.5	Sec

**NOTES:**

1. "Typicals" are not guaranteed, but based on samples from production lots. Data taken at 25°C, 12.0V V<sub>PP</sub>.
2. Minimum byte programming time excluding system overhead is 16  $\mu$ sec (10  $\mu$ sec program + 6  $\mu$ sec write recovery), while maximum is 400  $\mu$ sec/byte (16  $\mu$ sec x 25 loops allowed by algorithm). Max chip programming time is specified lower than the worst case allowed by the programming algorithm since most bytes program significantly faster than the worst case byte.
3. Excludes 00H programming prior to erasure.
4. Excludes system level overhead.







**ORDERING INFORMATION**

<div style="display: flex; justify-content: center; gap: 5px;"> <div style="border: 1px solid black; padding: 2px;">T</div> <div style="border: 1px solid black; padding: 2px;">P</div> <div style="border: 1px solid black; padding: 2px;">2</div> <div style="border: 1px solid black; padding: 2px;">8</div> <div style="border: 1px solid black; padding: 2px;">F</div> <div style="border: 1px solid black; padding: 2px;">0</div> <div style="border: 1px solid black; padding: 2px;">1</div> <div style="border: 1px solid black; padding: 2px;">0</div> <div style="border: 1px solid black; padding: 2px;">-</div> <div style="border: 1px solid black; padding: 2px;">1</div> <div style="border: 1px solid black; padding: 2px;">2</div> <div style="border: 1px solid black; padding: 2px;">0</div> </div>									
<p>TEMPERATURE</p> <p>T = EXTENDED (-40°C to +85°C)</p> <p>BLANK = COMMERCIAL (0°C to +70°C)</p>	<p>PACKAGE</p> <p>P = 32-PIN PLASTIC DIP</p> <p>N = 32-LEAD PLCC</p> <p>E = STANDARD 32-LEAD TSOP</p> <p>F = REVERSE 32-LEAD TSOP</p>	<p>ACCESS SPEED (ns)</p> <p>120 ns</p> <p>150 ns</p>							
290207-20									
<b>VALID COMBINATIONS:</b>									
P28F010-65		N28F010-65		TN28F010-90					
P28F010-90		N28F010-90							
P28F010-120		N28F010-120							
P28F010-150		N28F010-150							
E28F010-65		F28F010-65		TE28F010-90					
E28F010-90		F28F010-90		TF28F010-90					
E28F010-120		F28F010-120							
E28F010-150		F28F010-150							

**ADDITIONAL INFORMATION**

		<b>Order Number</b>
ER-20,	“ETOX Flash Memory Technology”	294005
ER-24,	“Intel Flash Memory”	294008
ER-28,	“ETOX III Flash Memory Technology”	294012
RR-60,	“ETOX Flash Memory Reliability Data Summary”	293002
AP-316,	“Using Flash Memory for In-System Reprogrammable Nonvolatile Storage”	292046
AP-325	“Guide to Flash Memory Reprogramming”	292059

**REVISION HISTORY**

Number	Description
007	Removed <b>200 ns</b> Speed Bin Revised Erase Maximum Pulse Count for Figure 5 from <b>3000</b> to <b>1000</b> Clarified AC and DC Test Conditions Added “dimple” to F TSOP Package Corrected Serpentine Layout
008	Corrected AC Waveforms Added Extended Temperature Options
009	Added 28F010-65 and 28F010-90 speeds Revised Symbols, i.e., $\overline{CE}$ , $\overline{OE}$ , etc. to CE #, OE #, etc.
010	Completion of Read Operation Table Labelling of Program Time in Erase/Program Table Textual Changes or Edits Corrected Erase/Program Times

