

Power Transistor (−80V, −1A)

2SB1260 / 2SB1181 / 2SB1241

●Features

- 1) High breakdown voltage and high current.
BV_{CEO}= −80V, I_c=−1A
- 2) Good h_{FE} linearity.
- 3) Low V_{CE(sat)}.
- 4) Complements the 2SD1898 / 2SD1863 / 2SD1733.

●Structure

Epitaxial planar type
PNP silicon transistor

●External dimensions (Units : mm)

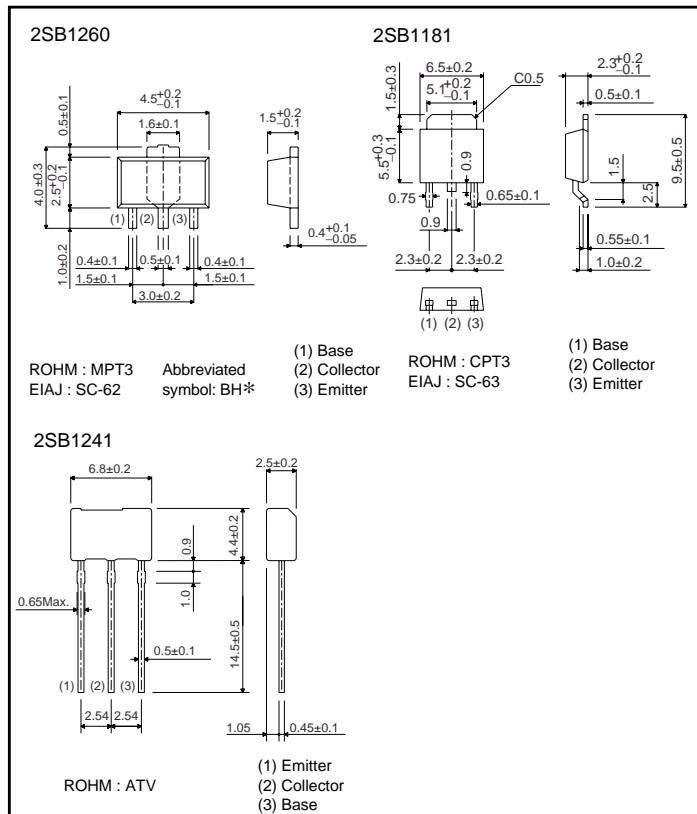

* Denotes h_{FE}

●Absolute maximum ratings (T_a=25°C)

Parameter	Symbol	Limits	Unit
Collector-base voltage	V _{CB0}	-80	V
Collector-emitter voltage	V _{CEO}	-80	V
Emitter-base voltage	V _{EB0}	-5	V
Collector current	I _c	-1	A(DC)
	I _{CP}	-2	A(Pulse) *1
Collector power dissipation	P _c	0.5	W *2
		2	
		10	W(T _c =25°C) *3
Junction temperature	T _j	150	°C
Storage temperature	T _{stg}	-55~+150	°C

*1 Single pulse, P_w=100ms

*2 When mounted on a 40×40×0.7 mm ceramic board.

*3 Printed circuit board, 1.7mm thick, collector copper plating 100mm² or larger.

Transistors

●Electrical characteristics (Ta=25°C)

Parameter	Symbol	Min.	Typ.	Max.	Unit	Conditions	
Collector-base breakdown voltage	BV _{CBO}	-80	-	-	V	I _C =-50μA	
Collector-emitter breakdown voltage	BV _{CEO}	-80	-	-	V	I _C =-1mA	
Emitter-base breakdown voltage	BV _{EBO}	-5	-	-	V	I _E =-50μA	
Collector cutoff current	I _{CBO}	-	-	-1	μA	V _{CB} =-60V	
Emitter cutoff current	I _{EBO}	-	-	-1	μA	V _{EB} =-4V	
Collector-emitter saturation voltage	V _{CE(sat)}	-	-	-0.4	V	I _C /I _E =-500mA/-50mA	
DC current transfer ratio	2SB1260, 2SB1181	h _{FE}	82	-	390	-	V _{CE} =-3V, I _C =-0.1A
	2SB1241		120	-	390	-	
Transition frequency	2SB1260, 2SB1241	f _T	-	100	-	MHz	V _{CE} =-5V, I _E =50mA, f=30MHz
	2SB1181		-	100	-	MHz	V _{CE} =-10V, I _E =50mA, f=30MHz
Output capacitance	C _{ob}	-	25	-	pF	V _{CB} =-10V, I _E =0A, f=1MHz	

●Packaging specifications and h_{FE}

Type	h _{FE}	Package	Taping		
		Code	TL	TV2	T100
		Basic ordering unit (pieces)	2500	2500	1000
2SB1260	PQR		-	-	○
2SB1241	QR		-	○	-
2SB1181	PQR		○	-	-

h_{FE} values are classified as follows :

Item	P	Q	R
h _{FE}	82~180	120~270	180~390

●Electrical characteristic curves

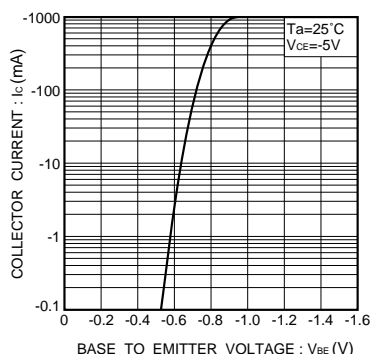

Fig.1 Grounded emitter propagation characteristics

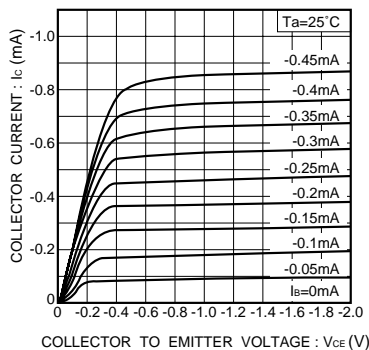

Fig.2 Grounded emitter output characteristics

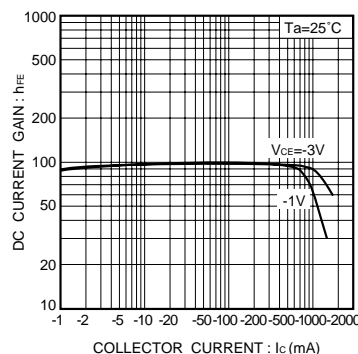

Fig.3 DC current gain vs. collector current

Transistors

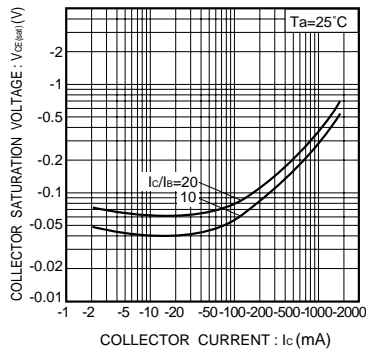

Fig. 4 Collector-emitter saturation voltage vs. collector current

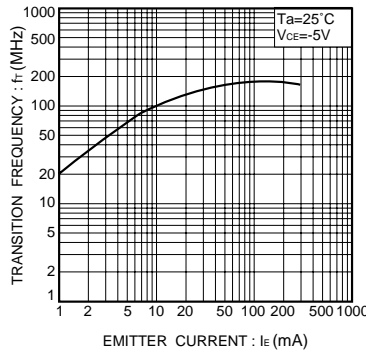

Fig. 5 Gain bandwidth product vs. emitter current

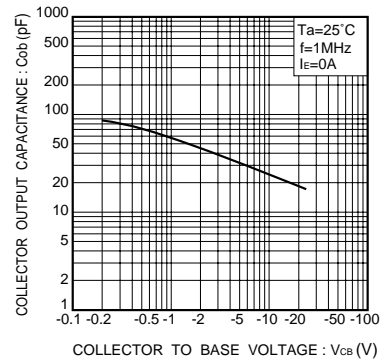

Fig. 6 Collector output capacitance vs. collector-base voltage

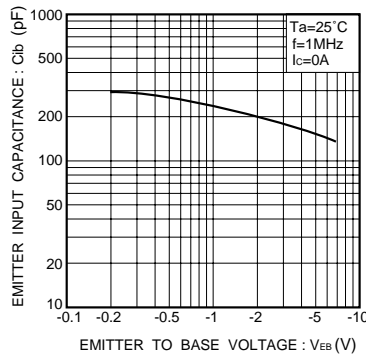

Fig. 7 Emitter input capacitance vs. emitter-base voltage

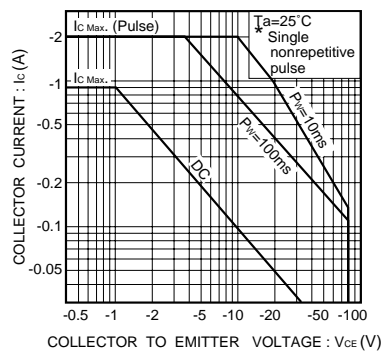

Fig. 8 Safe operating area (2SB1260)

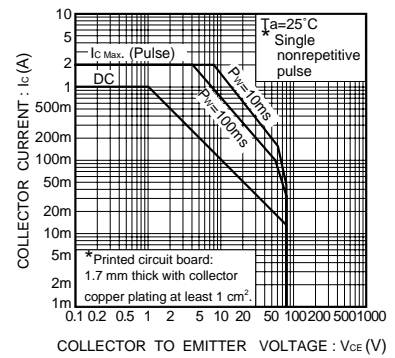

Fig. 9 Safe operating area (2SB1241)

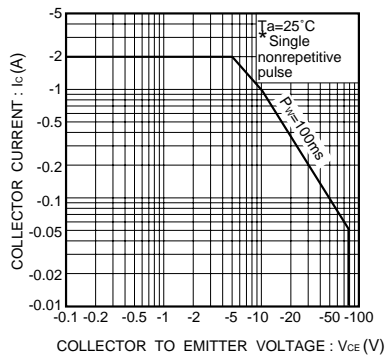

Fig. 10 Safe operating area (2SB1181)