

FEATURES

- Very low offset voltage: 10 μV maximum over temperature**
- Very low input offset voltage drift: 60 nV/ $^{\circ}\text{C}$ maximum**
- High CMRR: 96 dB minimum**
- Digitally programmable gain and output offset voltage**
- Single-wire serial interface**
- Open and short wire fault detection**
- Low-pass filtering**
- Stable with any capacitive load**
- Externally programmable output clamp voltage for driving low voltage ADCs**
- LFCSP-16 and SOIC-8 packages**
- 2.7 V to 5.5 V operation**
- 40 $^{\circ}\text{C}$ to +125 $^{\circ}\text{C}$ operation**

APPLICATIONS

- Automotive sensors**
- Pressure and position sensors**
- Thermocouple amplifiers**
- Industrial weigh scales**
- Precision current sensing**
- Strain gages**

GENERAL DESCRIPTION

The AD8555 is a zero-drift, sensor signal amplifier with digitally programmable gain and output offset. Designed to easily and accurately convert variable pressure sensor and strain bridge outputs to a well-defined output voltage range, the AD8555 also accurately amplifies many other differential or single-ended sensor outputs. The AD8555 uses the ADI patented low noise auto-zero and DigiTrim[®] technologies to create an incredibly accurate and flexible signal processing solution in a very compact footprint.

Gain is digitally programmable in a wide range from 70 to 1,280 through a serial data interface. Gain adjustment can be fully simulated in-circuit and then permanently programmed with proven and reliable poly-fuse technology. Output offset voltage is also digitally programmable and is ratiometric to the supply voltage.

Rev. 0

Information furnished by Analog Devices is believed to be accurate and reliable. However, no responsibility is assumed by Analog Devices for its use, nor for any infringements of patents or other rights of third parties that may result from its use. Specifications subject to change without notice. No license is granted by implication or otherwise under any patent or patent rights of Analog Devices. Trademarks and registered trademarks are the property of their respective owners.

FUNCTIONAL BLOCK DIAGRAM

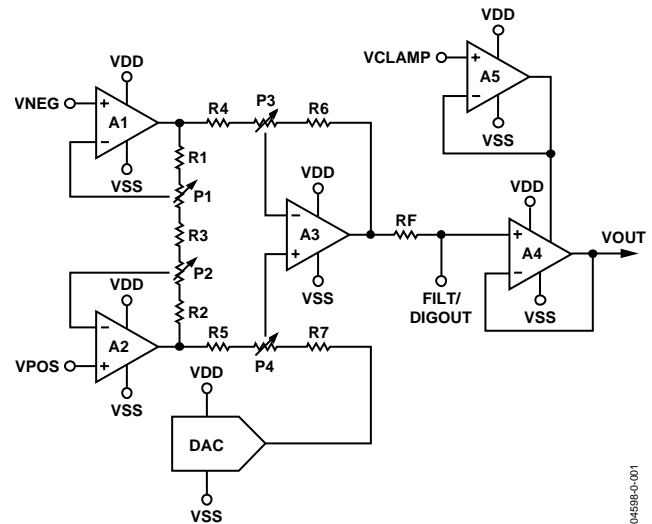

Figure 1.

In addition to extremely low input offset voltage and input offset voltage drift and very high dc and ac CMRR, the AD8555 also includes a pull-up current source at the input pins and a pull-down current source at the VCLAMP pin. This allows open wire and shorted wire fault detection. A low-pass filter function is implemented via a single low cost external capacitor. Output clamping set via an external reference voltage allows the AD8555 to drive lower voltage ADCs safely and accurately.

When used in conjunction with an ADC referenced to the same supply, the system accuracy becomes immune to normal supply voltage variations. Output offset voltage can be adjusted with a resolution of better than 0.4% of the difference between VDD and VSS. A lockout trim after gain and offset adjustment further ensures field reliability.

The AD8555AR is fully specified over the extended industrial temperature range of -40 $^{\circ}\text{C}$ to +125 $^{\circ}\text{C}$. Operating from single-supply voltages of 2.7 V to 5.5 V, the AD8555 is offered in the narrow 8-lead SOIC package and the 4 mm \times 4 mm 16-lead LFCSP.

TABLE OF CONTENTS

| | | | |
|---|----|--|----|
| Electrical Specifications | 3 | Device Programming..... | 19 |
| Absolute Maximum Ratings..... | 7 | Filtering Function..... | 25 |
| Pin Configurations and Function Descriptions | 8 | Driving Capacitive Loads..... | 25 |
| Typical Performance Characteristics | 9 | RF Interference | 26 |
| Theory of Operation | 17 | Single-Supply Data Acquisition System | 26 |
| Gain Values..... | 18 | Using the AD8555 with Capacitive Sensors | 27 |
| Open Wire Fault Detection..... | 19 | Outline Dimensions | 28 |
| Shorted Wire Fault Detection | 19 | Ordering Guide | 28 |
| Floating VPOS, VNEG, or VCLAMP Fault Detection..... | 19 | | |

REVISION HISTORY

4/04—Revision 0: Initial Version

ELECTRICAL SPECIFICATIONS

At $V_{DD} = 5.0\text{ V}$, $V_{SS} = 0.0\text{ V}$, $V_{CM} = 2.5\text{ V}$, $V_O = 2.5\text{ V}$, $-40^\circ\text{C} \leq T_A \leq +125^\circ\text{C}$, unless otherwise specified.

Table 1.

| Parameter | Symbol | Conditions | Min | Typ | Max | Unit |
|---|--------------------|--|------|------|------|--------------------------------|
| INPUT STAGE | | | | | | |
| Input Offset Voltage | V_{OS} | | | 2 | 10 | μV |
| Input Offset Voltage Drift | $T_C V_{OS}$ | | | 25 | 65 | $\text{nV}/^\circ\text{C}$ |
| Input Bias Current | I_B | $T_A = 25^\circ\text{C}$ | 12 | 16 | 22 | nA |
| | | | | | 25 | nA |
| Input Offset Current | I_{OS} | $T_A = 25^\circ\text{C}$ | | 0.2 | 1 | nA |
| | | | | | 1.5 | nA |
| Input Voltage Range | | | 0.6 | | 3.8 | V |
| Common-Mode Rejection Ratio | CMRR | $V_{CM} = 0.9\text{ V to } 3.6\text{ V}$, $A_V = 70$ | 80 | 92 | | dB |
| | | $V_{CM} = 0.9\text{ V to } 3.6\text{ V}$, $A_V = 1,280$ | 96 | 112 | | dB |
| Linearity | | $V_O = 0.2\text{ V to } 3.4\text{ V}$ | | 20 | | ppm |
| | | $V_O = 0.2\text{ V to } 4.8\text{ V}$ | | 1000 | | ppm |
| Differential Gain Accuracy | | Second Stage Gain = 17.5 to 100 | | 0.35 | 1.6 | $\%$ |
| | | Second Stage Gain = 140 to 200 | | 0.5 | 2.5 | $\%$ |
| Differential Gain Temperature Coefficient | | Second Stage Gain = 17.5 to 100 | | 15 | 40 | $\text{ppm}/^\circ\text{C}$ |
| | | Second Stage Gain = 140 to 200 | | 40 | 100 | $\text{ppm}/^\circ\text{C}$ |
| RF | | | 14 | 18 | 22 | $\text{k}\Omega$ |
| RF Temperature Coefficient | | | | 700 | | $\text{ppm}/^\circ\text{C}$ |
| DAC | | | | | | |
| Accuracy | | $A_V = 70$, Offset Codes = 8 to 248 | | 0.7 | 0.8 | $\%$ |
| Ratiometricity | | $A_V = 70$, Offset Codes = 8 to 248 | | 50 | | ppm |
| Output Offset | | $A_V = 70$, Offset Codes = 8 to 248 | | 5 | 35 | mV |
| Temperature Coefficient | | | | 3.3 | 15 | $\text{ppm FS}/^\circ\text{C}$ |
| VCLAMP | | | | | | |
| Input Bias Current | | $T_A = 25^\circ\text{C}$, $V_{CLAMP} = 5\text{ V}$ | | 200 | | nA |
| | | | | 500 | | nA |
| Input Voltage Range | | | 1.25 | | 4.94 | V |
| OUTPUT BUFFER STAGE | | | | | | |
| Buffer Offset | | | | 7 | 15 | mV |
| Short-Circuit Current | I_{SC} | | 5 | | 10 | mA |
| Output Voltage, Low | V_{OL} | $R_L = 10\text{ k}\Omega$ to 5 V | | | 30 | mV |
| Output Voltage, High | V_{OH} | $R_L = 10\text{ k}\Omega$ to 0 V | 4.94 | | | V |
| POWER SUPPLY | | | | | | |
| Supply Current | I_{SY} | $V_O = 2.5\text{ V}$, $V_{POS} = V_{NEG} = 2.5\text{V}$, V_{DAC} Code = 128 | | 2.0 | 2.5 | mA |
| Power Supply Rejection Ratio | PSRR | $A_V = 70$ | 109 | 125 | | dB |
| DYNAMIC PERFORMANCE | | | | | | |
| Gain Bandwidth Product | GBP | First Gain Stage, $T_A = 25^\circ\text{C}$ | | 2 | | MHz |
| | | Second Gain Stage, $T_A = 25^\circ\text{C}$ | | 8 | | MHz |
| | | Output Buffer Stage | | 1.5 | | MHz |
| Output Buffer Slew Rate | SR | $A_V = 70$, $R_L = 10\text{ k}\Omega$, $C_L = 100\text{ pF}$ | | 1.2 | | $\text{V}/\mu\text{s}$ |
| Settling Time | t_s | To 0.1%, $A_V = 70$, 4 V Output Step | | 8 | | μs |
| NOISE PERFORMANCE | | | | | | |
| Input Referred Noise | | $T_A = 25^\circ\text{C}$, $f = 1\text{ kHz}$ | | 32 | | $\text{nV}/\sqrt{\text{Hz}}$ |
| Low Frequency Noise | $e_{n\text{ p-p}}$ | $f = 0.1\text{ Hz to } 10\text{ Hz}$ | | 0.5 | | $\mu\text{V p-p}$ |
| Total Harmonic Distortion | THD | $V_{IN} = 16.75\text{ mV rms}$, $f = 1\text{ kHz}$, $A_V = 100$ | | -100 | | dB |

AD8555

| Parameter | Symbol | Conditions | Min | Typ | Max | Unit |
|------------------------------|----------|--------------------------|------|-----|-----|---------------|
| DIGITAL INTERFACE | | | | | | |
| Input Current | | | | 2 | | μA |
| DIGIN Pulse Width to Load 0 | t_{w0} | $T_A = 25^\circ\text{C}$ | 0.05 | | 10 | μs |
| DIGIN Pulse Width to Load 1 | t_{w1} | $T_A = 25^\circ\text{C}$ | 50 | | | μs |
| Time between Pulses at DIGIN | t_{ws} | $T_A = 25^\circ\text{C}$ | 10 | | | μs |
| DIGIN Low | | $T_A = 25^\circ\text{C}$ | | | 1 | V |
| DIGIN High | | $T_A = 25^\circ\text{C}$ | 4 | | | V |
| DIGOUT Logic 0 | | $T_A = 25^\circ\text{C}$ | | | 1 | V |
| DIGOUT Logic 1 | | $T_A = 25^\circ\text{C}$ | 4 | | | V |

At $V_{DD} = 2.7\text{ V}$, $V_{SS} = 0.0\text{ V}$, $V_{CM} = 1.35\text{ V}$, $V_O = 1.35\text{ V}$, $-40^\circ\text{C} \leq T_A \leq +125^\circ\text{C}$, unless otherwise specified.

Table 2.

| Parameter | Symbol | Conditions | Min | Typ | Max | Unit |
|---|--------------------|---|------|------|------|--------------------------------|
| INPUT STAGE | | | | | | |
| Input Offset Voltage | V_{OS} | | | 2 | 10 | μV |
| Input Offset Voltage Drift | $T_C V_{OS}$ | | | 25 | 60 | $\text{nV}/^\circ\text{C}$ |
| Input Bias Current | I_B | $T_A = 25^\circ\text{C}$ | 12 | 16 | | nA |
| Input Offset Current | I_{OS} | $T_A = 25^\circ\text{C}$ | | 0.2 | 1 | nA |
| | | | | | 1.5 | nA |
| Input Voltage Range | | | 0.5 | | 1.6 | V |
| Common-Mode Rejection Ratio | CMRR | $V_{CM} = 0.9\text{ V to } 1.3\text{ V}$, $A_V = 70$ | 80 | 92 | | dB |
| | | $V_{CM} = 0.9\text{ V to } 1.3\text{ V}$, $A_V = 1,280$ | 96 | 112 | | dB |
| Linearity | | $V_O = 0.2\text{ V to } 3.4\text{ V}$ | | 20 | | ppm |
| | | $V_O = 0.2\text{ V to } 4.8\text{ V}$ | | 1000 | | ppm |
| Differential Gain Accuracy | | Second Stage Gain = 17.5 to 100 | | 0.35 | | $\%$ |
| | | Second Stage Gain = 140 to 200 | | 0.5 | | $\%$ |
| Differential Gain Temperature Coefficient | | Second Stage Gain = 17.5 to 100 | | 15 | | $\text{ppm}/^\circ\text{C}$ |
| | | Second Stage Gain = 140 to 200 | | 40 | | $\text{ppm}/^\circ\text{C}$ |
| RF | | | 14 | 18 | 22 | $\text{k}\Omega$ |
| RF Temperature Coefficient | | | | 700 | | $\text{ppm}/^\circ\text{C}$ |
| DAC | | | | | | |
| Accuracy | | $A_V = 70$, Offset Codes = 8 to 248 | | 0.7 | | $\%$ |
| Ratiometricity | | $A_V = 70$, Offset Codes = 8 to 248 | | 50 | | ppm |
| Output Offset | | $A_V = 70$, Offset Codes = 8 to 248 | | 5 | 35 | mV |
| Temperature Coefficient | | | | 3.3 | | $\text{ppm FS}/^\circ\text{C}$ |
| VCLAMP | | | | | | |
| Input Bias Current | | $T_A = 25^\circ\text{C}$, $V_{CLAMP} = 2.7\text{ V}$ | | 200 | | nA |
| | | | | 500 | | nA |
| Input Voltage Range | | | 1.25 | | 2.64 | V |
| OUTPUT BUFFER STAGE | | | | | | |
| Buffer Offset | | | | 7 | 15 | mV |
| Short-Circuit Current | I_{SC} | | 4.5 | | 9.5 | mA |
| Output Voltage, Low | V_{OL} | $R_L = 10\text{ k}\Omega$ to 5 V | | | 30 | mV |
| Output Voltage, High | V_{OH} | $R_L = 10\text{ k}\Omega$ to 0 V | 2.64 | | | V |
| POWER SUPPLY | | | | | | |
| Supply Current | I_{SY} | $V_O = 1.35\text{ V}$, $V_{POS} = V_{NEG} = 1.35\text{ V}$, V_{DAC} Code = 128 | | 2.0 | | mA |
| Power Supply Rejection Ratio | PSRR | $A_V = 70$ | 109 | 125 | | dB |
| DYNAMIC PERFORMANCE | | | | | | |
| Gain Bandwidth Product | GBP | First Gain Stage, $T_A = 25^\circ\text{C}$ | | 2 | | MHz |
| | | Second Gain Stage, $T_A = 25^\circ\text{C}$ | | 8 | | MHz |
| | | Output Buffer Stage | | 1.5 | | MHz |
| Output Buffer Slew Rate | SR | $A_V = 70$, $R_L = 10\text{ k}\Omega$, $C_L = 100\text{ pF}$ | | 1.2 | | $\text{V}/\mu\text{s}$ |
| Settling Time | t_s | To 0.1%, $A_V = 70$, 4 V Output Step | | 8 | | μs |
| NOISE PERFORMANCE | | | | | | |
| Input Referred Noise | | $T_A = 25^\circ\text{C}$, $f = 1\text{ kHz}$ | | 32 | | $\text{nV}/\sqrt{\text{Hz}}$ |
| Low Frequency Noise | $e_{n\text{ p-p}}$ | $f = 0.1\text{ Hz to } 10\text{ Hz}$ | | 0.3 | | $\mu\text{V p-p}$ |
| Total Harmonic Distortion | THD | $V_{IN} = 16.75\text{ mV rms}$, $f = 1\text{ kHz}$, $A_V = 100$ | | -100 | | dB |

AD8555

| Parameter | Symbol | Conditions | Min | Typ | Max | Unit |
|------------------------------|----------|--------------------------|------|-----|-----|---------------|
| DIGITAL INTERFACE | | | | | | |
| Input Current | | | | 2 | | μA |
| DIGIN Pulse Width to Load 0 | t_{w0} | $T_A = 25^\circ\text{C}$ | 0.05 | | 10 | μs |
| DIGIN Pulse Width to Load 1 | t_{w1} | $T_A = 25^\circ\text{C}$ | 50 | | | μs |
| Time between Pulses at DIGIN | t_{ws} | $T_A = 25^\circ\text{C}$ | 10 | | | μs |

ABSOLUTE MAXIMUM RATINGS

Table 3.

| Parameter | Rating |
|--|----------------------------|
| Supply Voltage | 6 V |
| Input Voltage | VSS – 0.3 V to VDD + 0.3 V |
| Differential Input Voltage ¹ | ±5.0 V |
| Output Short-Circuit Duration to VSS or VDD | Indefinite |
| Storage Temperature Range | –65°C to +150°C |
| Operating Temperature Range | –40°C to +125°C |
| Junction Temperature Range | –65°C to +150°C |
| Lead Temperature Range (Soldering, 10 sec) | 300°C |

Table 4.

| Package Type | θ_{JA} ² | θ_{JC} | Unit |
|--------------------|----------------------------|---------------|------|
| 8-Lead SOIC (R) | 158 | 43 | °C/W |
| 16-Lead LFCSP (CP) | 44 | 31.5 | °C/W |

¹ Differential input voltage is limited to ±5.0 V or ± the supply voltage, whichever is less.

² θ_{JA} is specified for the worst-case conditions, i.e., θ_{JA} is specified for device soldered in circuit board for SOIC and LFCSP packages.

AD8555

PIN CONFIGURATIONS AND FUNCTION DESCRIPTIONS

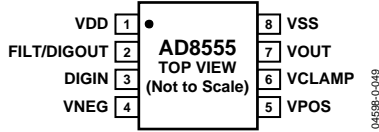

Figure 2. 8-Lead SOIC (Not Drawn to Scale)

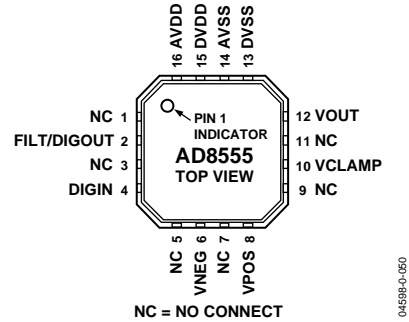

Figure 3. 16-Lead LFCSP (Not Drawn to Scale)

Table 5. Pin Configuration

| SOIC | | LFCSP | | Description |
|---------|-------------|-------------------|------------|--|
| Pin No. | Mnemonic | Pin No. | Mnemonic | |
| 1 | VDD | N/A | N/A | Positive Supply Voltage. |
| 2 | FILT/DIGOUT | 2 | FILTDIGOUT | Unbuffered Amplifier Output In Series with a Resistor RF. Adding a capacitor between FILT and VDD or VSS implements a low-pass filtering function. In read mode, this pin functions as a digital output. |
| 3 | DIGIN | 4 | DIGIN | Digital Input. |
| 4 | VNEG | 6 | VNEG | Negative Amplifier Input (Inverting Input). |
| 5 | VPOS | 8 | VPOS | Positive Amplifier Input (Noninverting Input). |
| 6 | VCLAMP | 10 | VCLAMP | Set Clamp Voltage at Output. |
| 7 | VOUT | 12 | VOUT | Buffered Amplifier Output. Buffered version of the signal at the FILT/DIGOUT pin. In read mode, VOUT is a buffered digital output. |
| 8 | VSS | N/A | N/A | Negative Supply Voltage. |
| N/A | N/A | 13, 14 | DVSS, AVSS | Negative Supply Voltage. |
| N/A | N/A | 15, 16 | DVDD, AVDD | Positive Supply Voltage. |
| N/A | N/A | 1, 3, 5, 7, 9, 11 | NC | Do Not Connect. |

TYPICAL PERFORMANCE CHARACTERISTICS

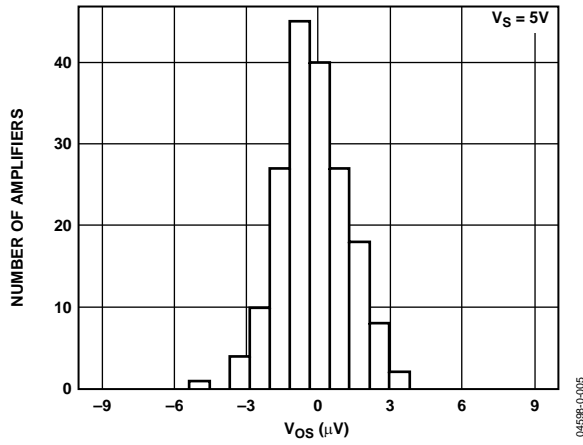

Figure 4. Input Offset Voltage Distribution

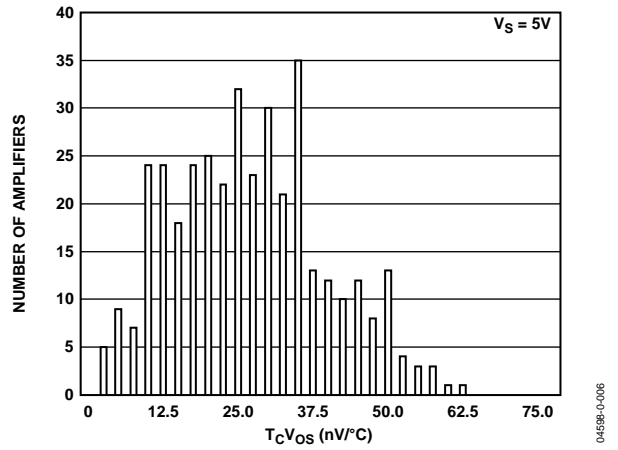

Figure 7. $T_C V_{OS}$ @ $V_S = 5V$

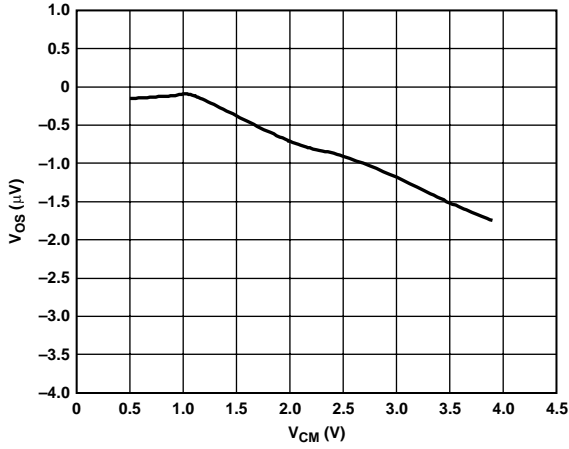

Figure 5. Input Offset Voltage vs. Common-Mode Voltage

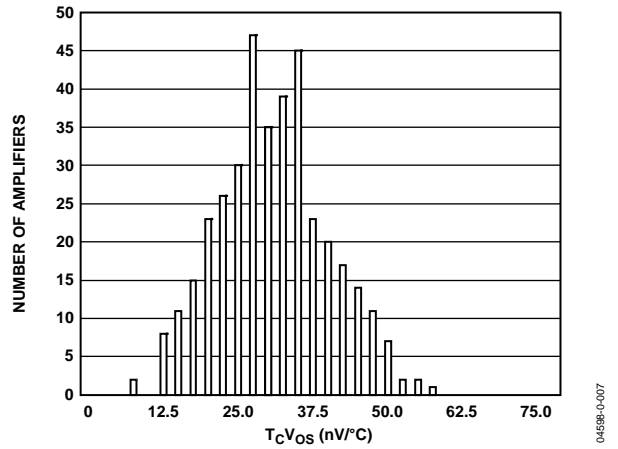

Figure 8. $T_C V_{OS}$ @ $V_S = 2.7V$

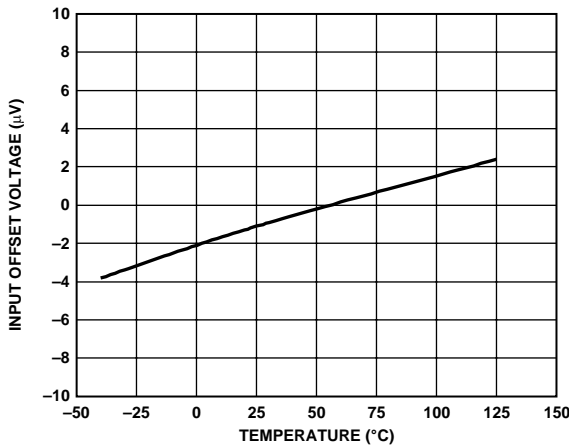

Figure 6. Input Offset Voltage vs. Temperature

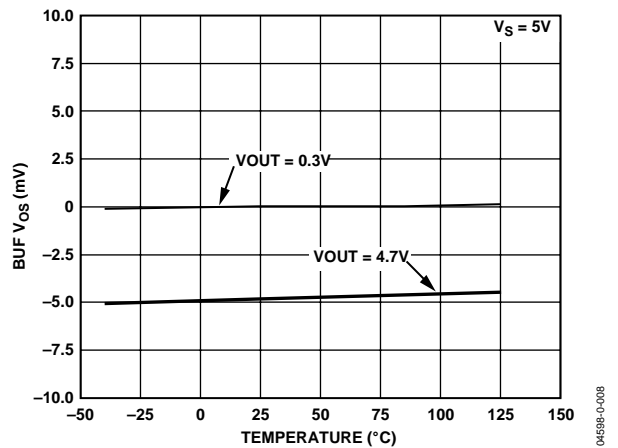

Figure 9. Output Buffer Offset vs. Temperature

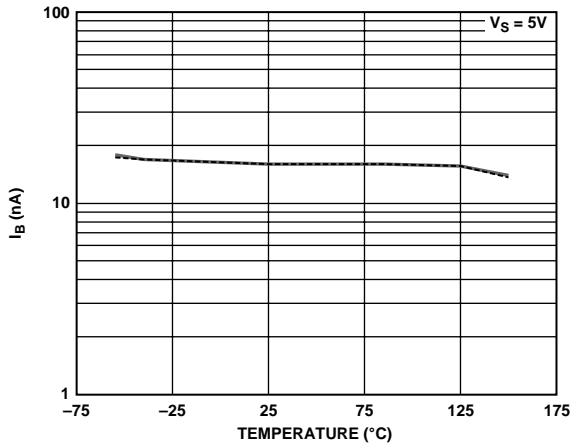

Figure 10. Input Bias Current at VPOS, VNEG vs. Temperature

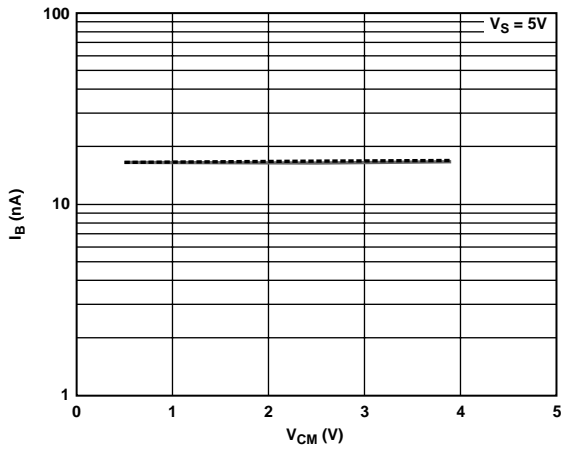

Figure 11. Input Bias Current at VPOS, VNEG vs. Common-Mode Voltage

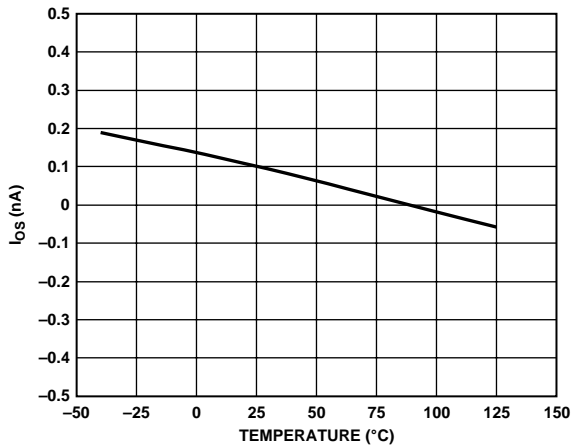

Figure 12. Input Offset Current vs. Temperature

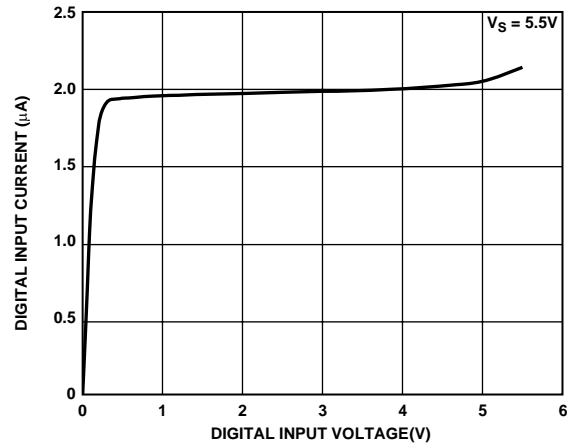

Figure 13. Digital Input Current vs. Digital Input Voltage (Pin 3)

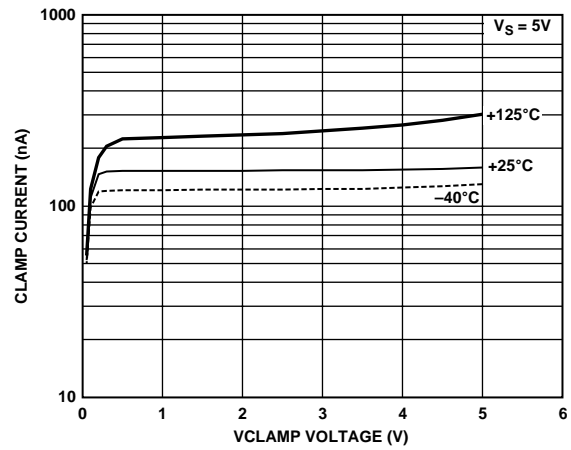

Figure 14. VCLAMP Current Over Temperature at $V_S = 5V$ vs. VCLAMP Voltage

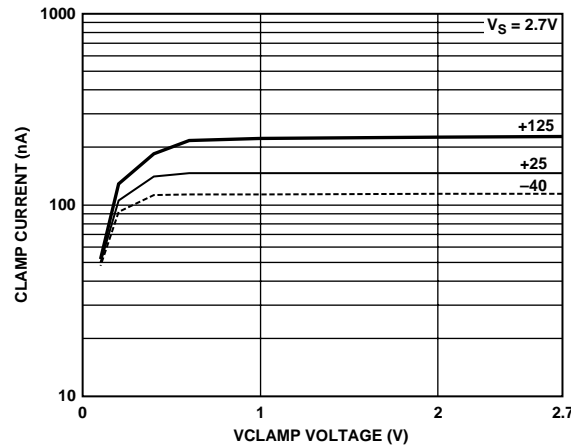

Figure 15. VCLAMP Current Over Temperature at $V_S = 2.7V$ vs. VCLAMP Voltage

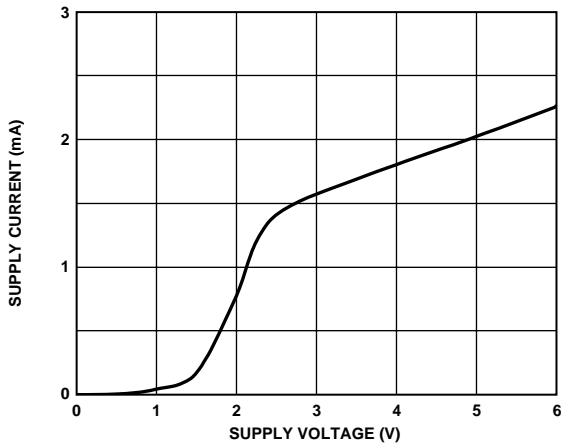

Figure 16. Supply Current (I_{SV}) vs. Supply Voltage

04598-0-014

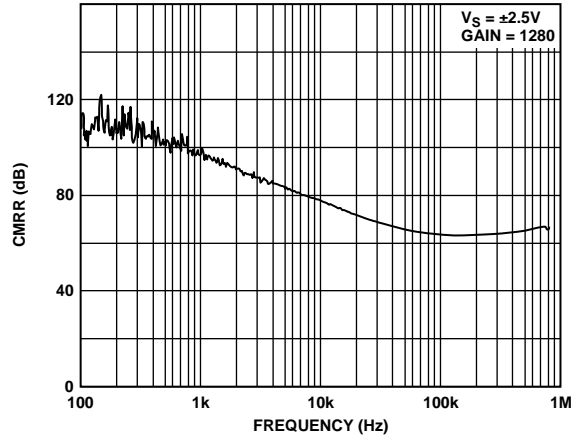

Figure 19. CMRR vs. Frequency

04598-0-017

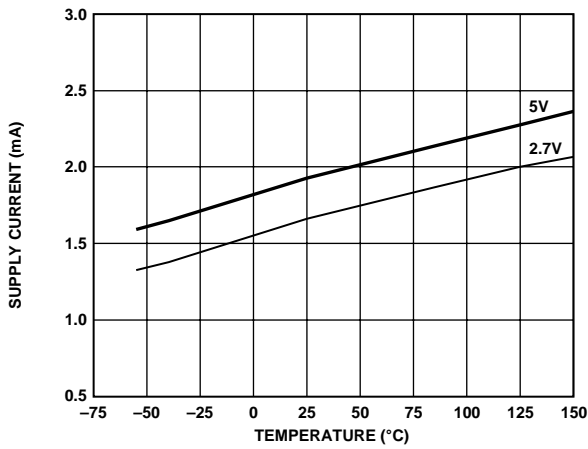

Figure 17. Supply Current (I_{SV}) vs. Temperature

04598-0-015

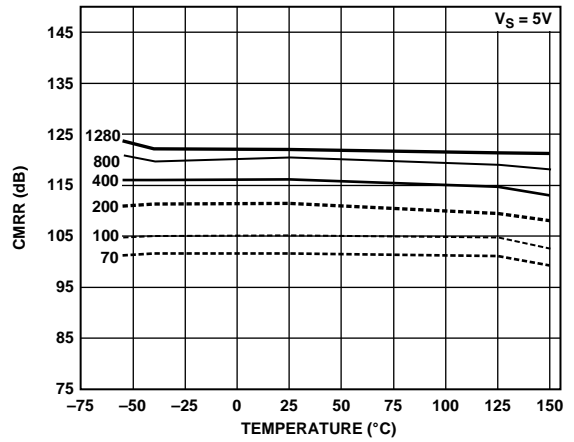

Figure 20. CMRR vs. Temperature at Different Gains

04598-0-018

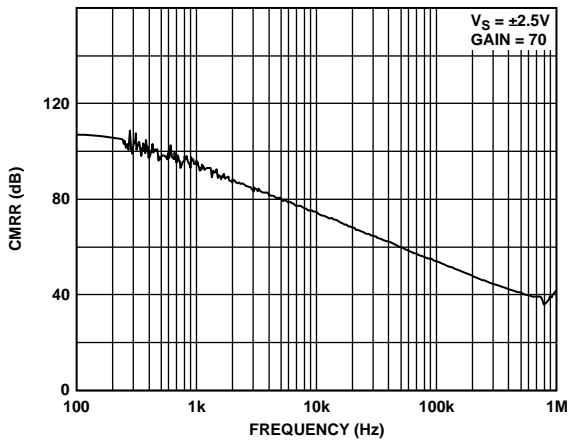

Figure 18. CMRR vs. Frequency

04598-0-016

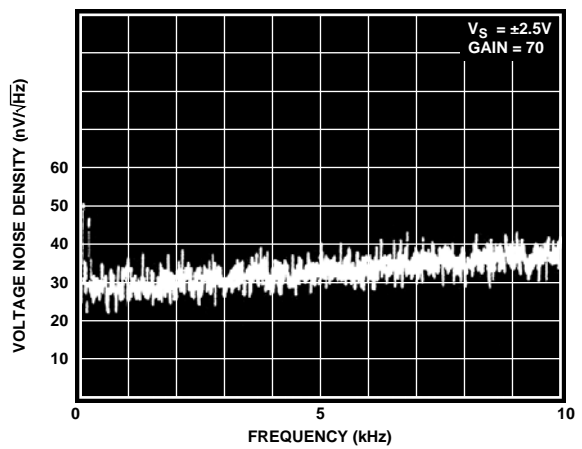

Figure 21. Input Voltage Noise Density vs. Frequency (0 Hz to 10 kHz)

04598-0-019

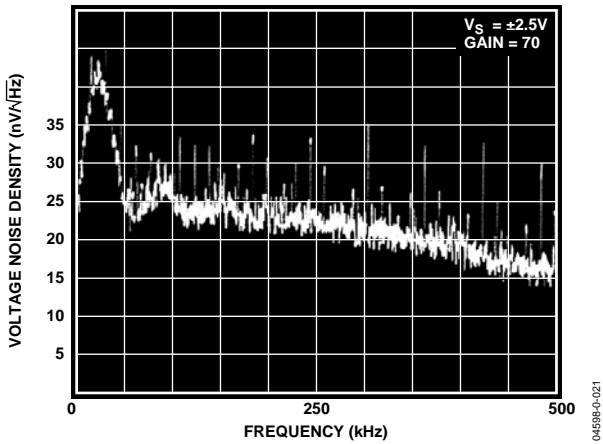

Figure 22. Input Voltage Noise Density vs. Frequency (0 Hz to 500 kHz)

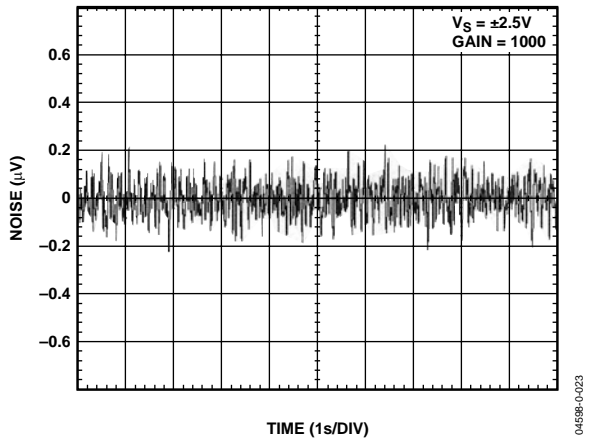

Figure 23. Low Frequency Input Voltage Noise (0.1 Hz to 10 Hz)

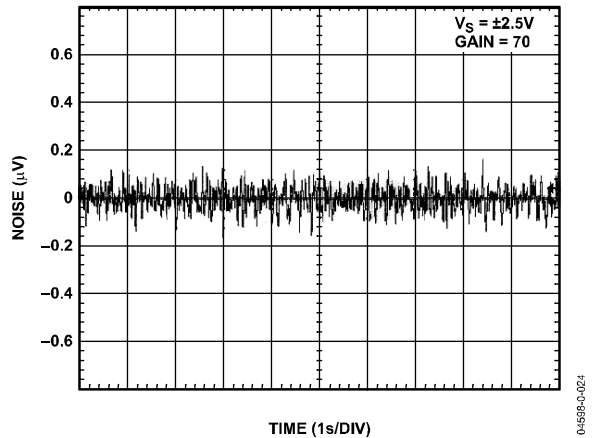

Figure 24. Low Frequency Input Voltage Noise (0.1 Hz to 10 Hz)

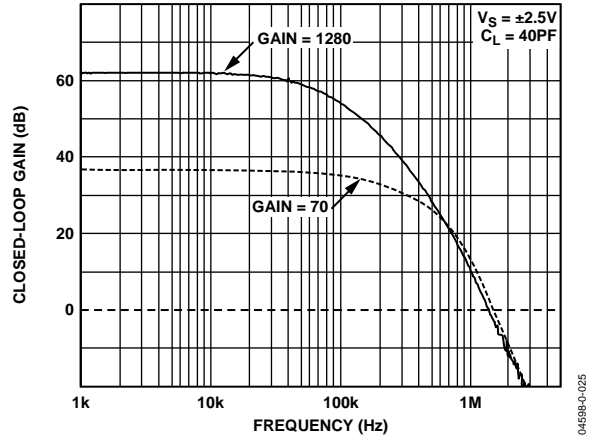

Figure 25. Closed-Loop Gain vs. Frequency Measured at Filter Pin

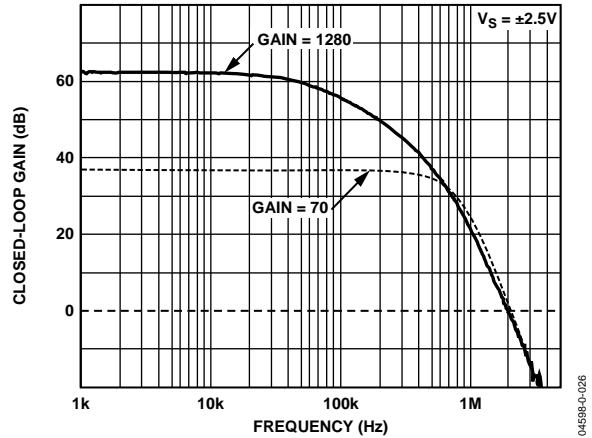

Figure 26. Closed-Loop Gain vs. Frequency Measured at Output Pin

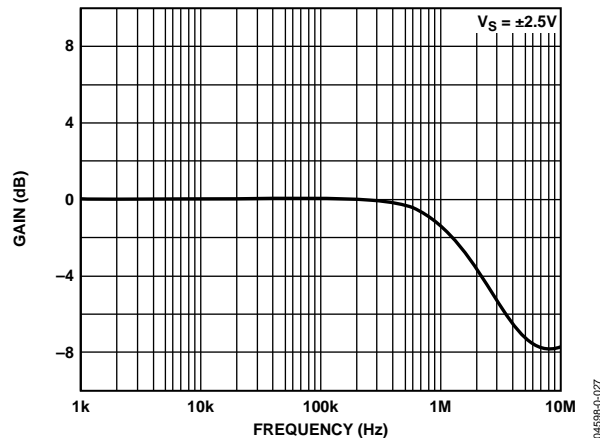

Figure 27. Output Buffer Gain vs. Frequency

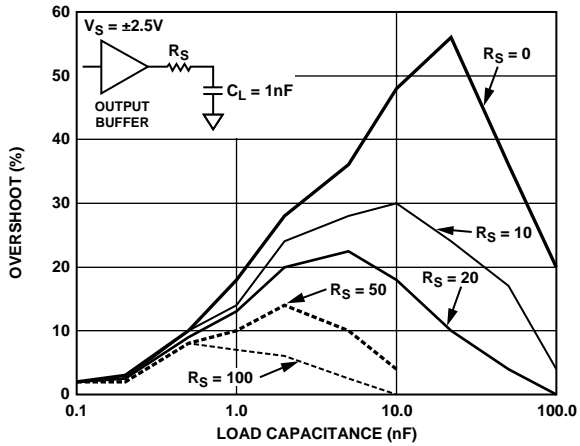

Figure 28. Output Buffer Positive Overshoot

04598-0-028

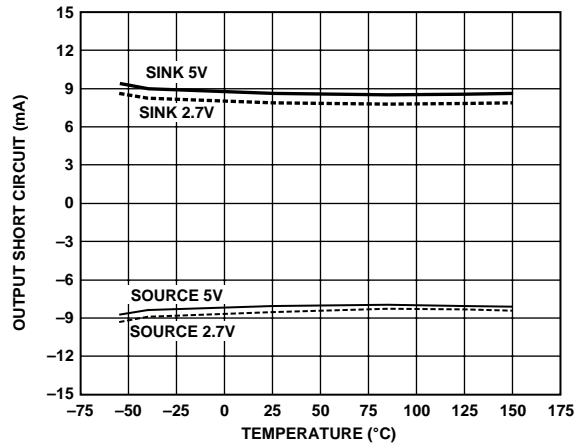

Figure 31. Output Short Circuit vs. Temperature

04598-0-031

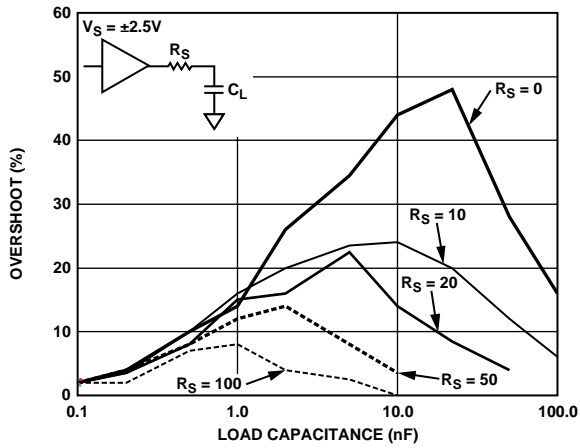

Figure 29. Output Buffer Negative Overshoot

04598-0-029

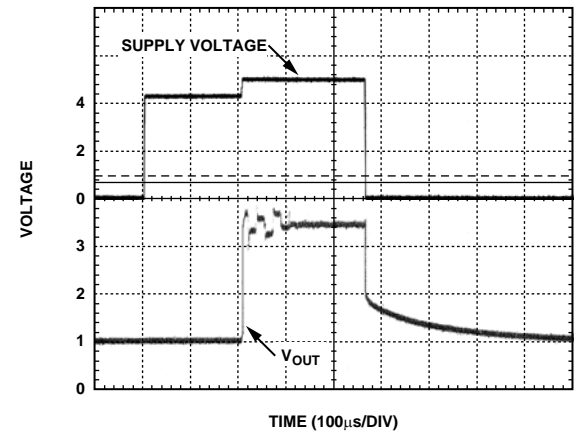

Figure 32. Power-On Response at 25°C

04598-0-032

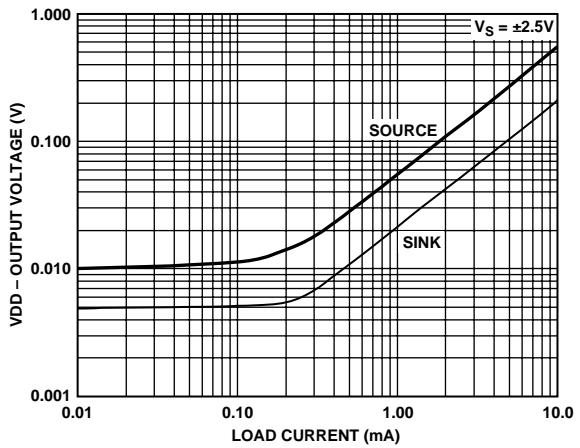

Figure 30. Output Voltage to Supply Rail vs. Load Current

04598-0-030

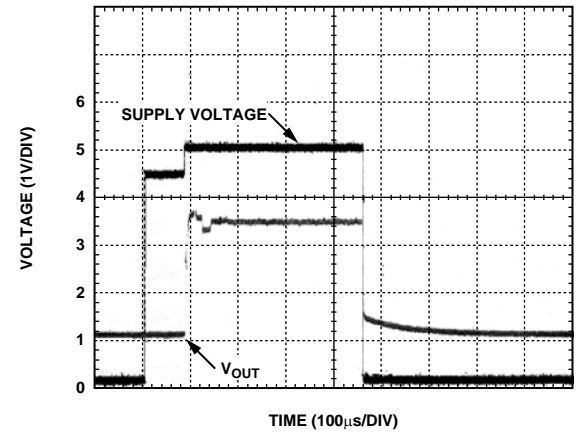

Figure 33. Power-On Response at 125°C

04598-0-033

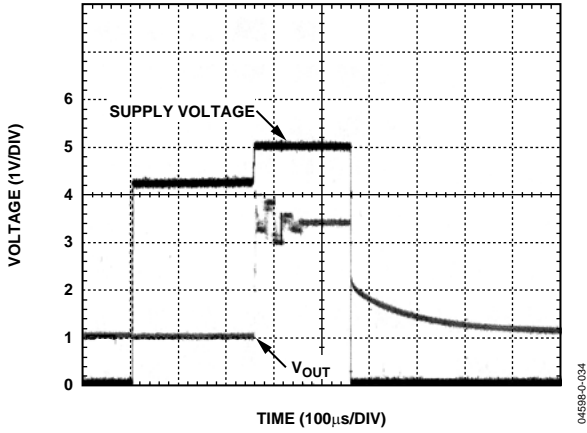

Figure 34. Power-On Response at -40°C

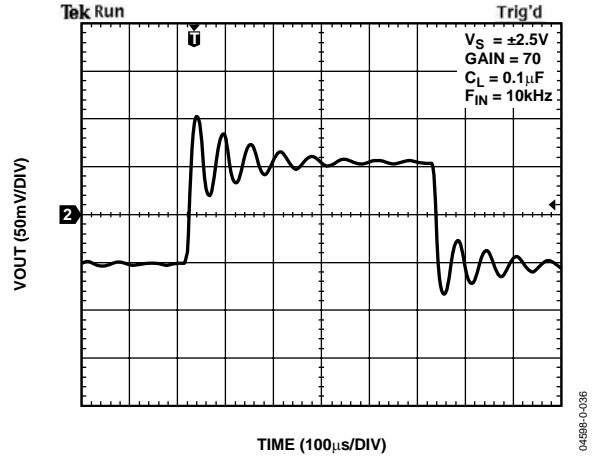

Figure 37. Small Signal Response

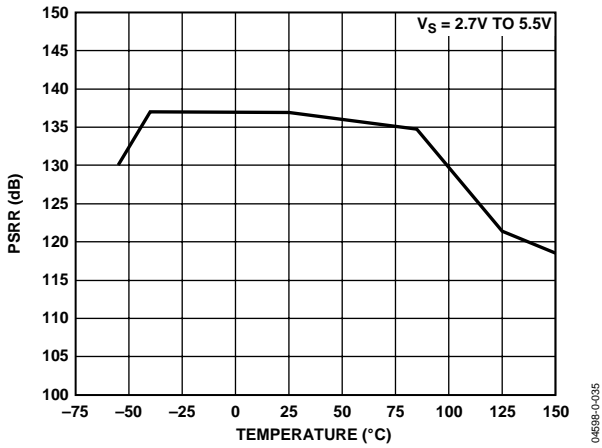

Figure 35. PSRR vs. Temperature

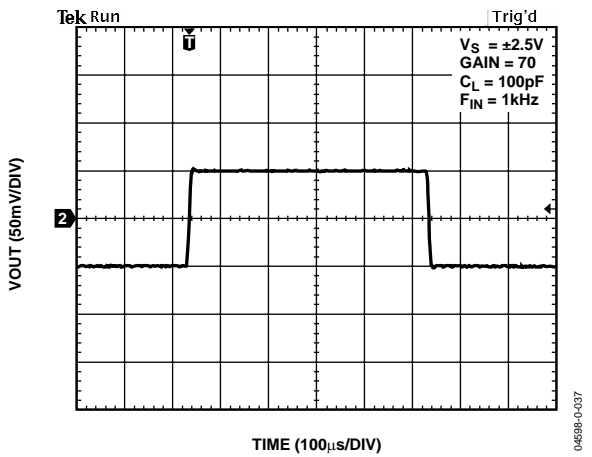

Figure 38. Small Signal Response

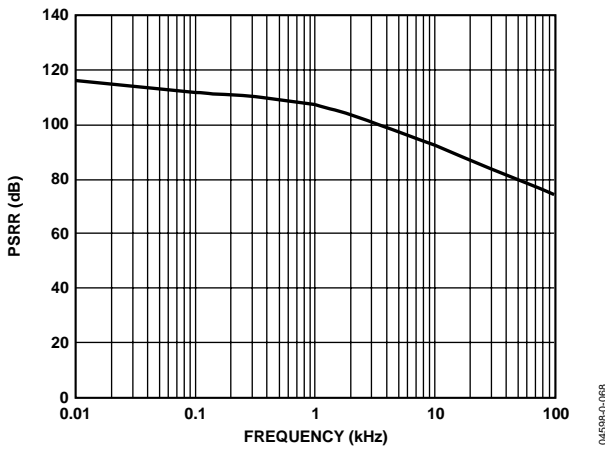

Figure 36. PSRR vs. Frequency

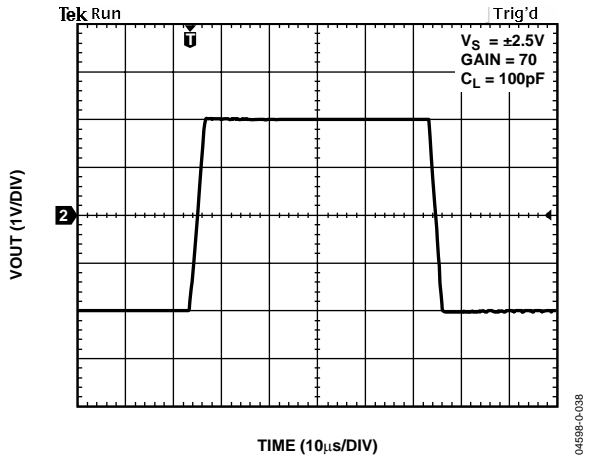

Figure 39. Large Signal Response

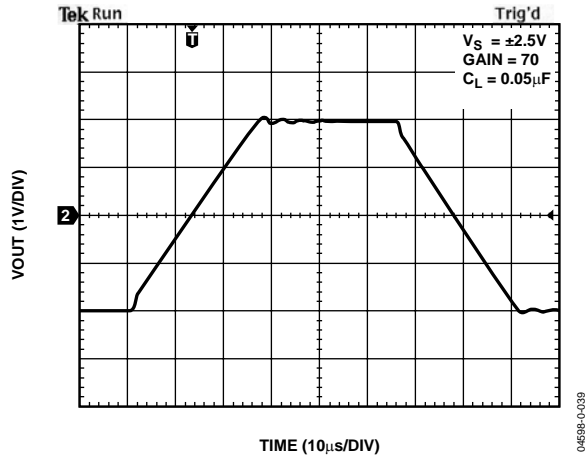

Figure 40. Large Signal Response

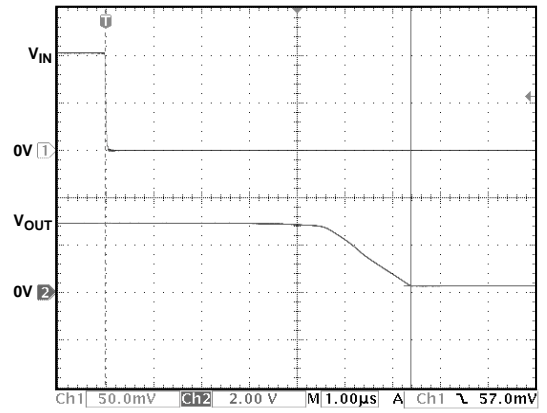

Figure 43. Positive Overload Recovery (Gain = 70)

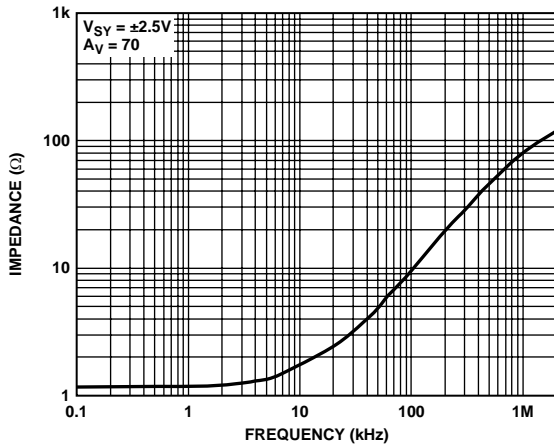

Figure 41. Output Impedance vs. Frequency

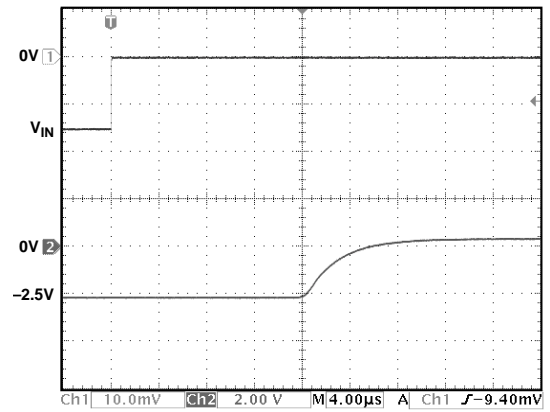

Figure 44. Negative Overload Recovery (Gain = 1280)

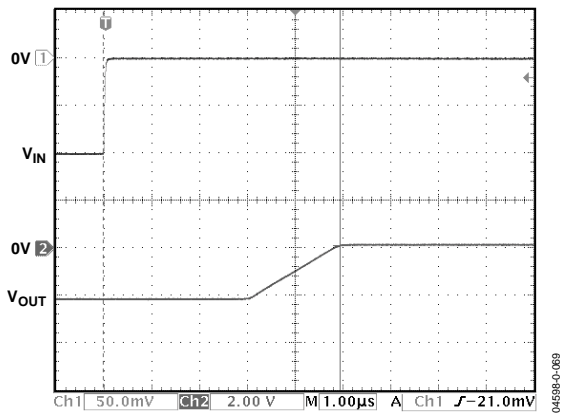

Figure 42. Negative Overload Recovery (Gain = 70)

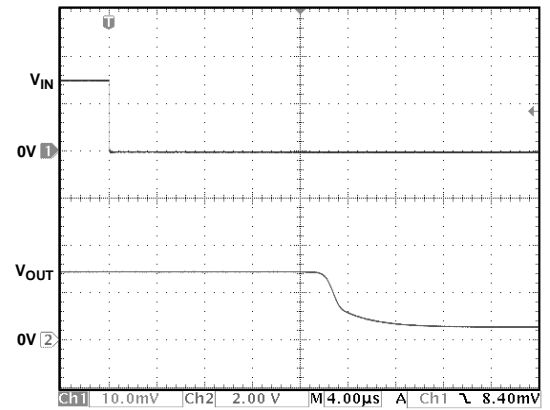

Figure 45. Positive Overload Recovery (Gain = 1280)

AD8555

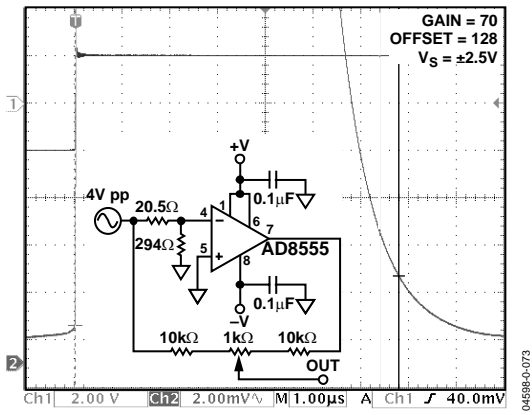

Figure 46. Settling Time 0.1%

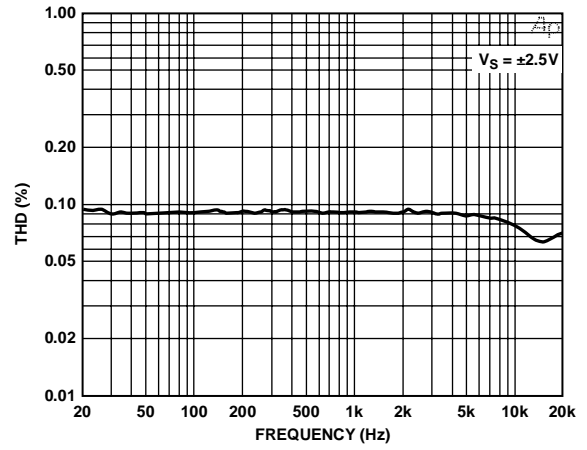

Figure 48. THD vs. Frequency

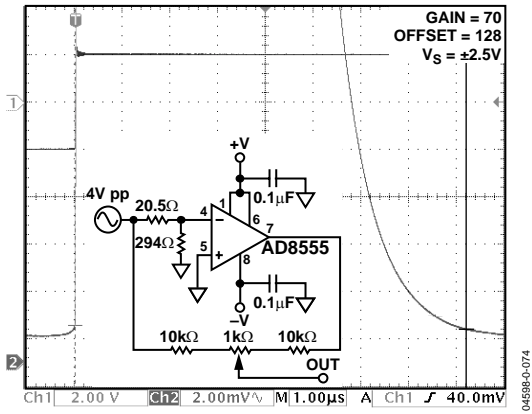

Figure 47. Settling Time 0.01%

THEORY OF OPERATION

A1, A2, R1, R2, R3, P1, and P2 form the first gain stage of the differential amplifier. A1 and A2 are auto-zeroed op amps that minimize input offset errors. P1 and P2 are digital potentiometers, guaranteed to be monotonic. Programming P1 and P2 allows the first stage gain to be varied from 4.0 to 6.4 with 7-bit resolution (see Table 6 and Equation 3), giving a fine gain adjustment resolution of 0.37%. R1, R2, R3, P1, and P2 each have a similar temperature coefficient, so the first stage gain temperature coefficient is lower than 100 ppm/°C.

A3, R4, R5, R6, R7, P3, and P4 form the second gain stage of the differential amplifier. A3 is also an auto-zeroed op amp that minimize input offset errors. P3 and P4 are digital potentiometers, allowing the second stage gain to be varied from 17.5 to 200 in eight steps (see Table 7); they allow the gain to be varied over a wide range. R4, R5, R6, R7, P3, and P4 each have a similar temperature coefficient, so the second stage gain temperature coefficient is lower than 100 ppm/°C.

RF together with an external capacitor connected between FILT/DIGOUT and VSS or VDD form a low-pass filter. The filtered signal is buffered by A4 to give a low impedance output at VOUT. RF is nominally 16 kΩ, allowing a 1 kHz low-pass filter to be implemented by connecting a 10 nF external capacitor between FILT/DIGOUT and VSS or between FILT/DIGOUT and VDD. If low-pass filtering is not needed, then the FILT/DIGOUT pin must be left floating.

A5 implements a voltage buffer, which provides the positive supply to the amplifier output buffer A4. Its function is to limit VOUT to a maximum value, useful for driving analog-to-digital converters (ADC) operating on supply voltages lower than

VDD. The input to A5, VCLAMP, has a very high input resistance. It should be connected to a known voltage and not left floating. However, the high input impedance allows the clamp voltage to be set using a high impedance source, e.g., a potential divider. If the maximum value of VOUT does not need to be limited, VCLAMP should be connected to VDD.

A4 implements a rail-to-rail input and output unity-gain voltage buffer. The output stage of A4 is supplied from a buffered version of VCLAMP instead of VDD, allowing the positive swing to be limited. The maximum output current is limited between 5 mA to 10 mA.

An 8-bit digital-to-analog converter (DAC) is used to generate a variable offset for the amplifier output. This DAC is guaranteed to be monotonic. To preserve the ratiometric nature of the input signal, the DAC references are driven from VSS and VDD, and the DAC output can swing from VSS (Code 0) to VDD (Code 255). The 8-bit resolution is equivalent to 0.39% of the difference between VDD and VSS, e.g., 19.5 mV with a 5 V supply. The DAC output voltage (VDAC) is given approximately by

$$VDAC \approx \left(\frac{Code + 0.5}{256} \right) (VDD - VSS) + VSS \quad (1)$$

The temperature coefficient of VDAC is lower than 200 ppm/°C.

The amplifier output voltage (VOUT) is given by

$$VOUT = GAIN(VPOS - VNEG) + VDAC \quad (2)$$

where *GAIN* is the product of the first and second stage gains.

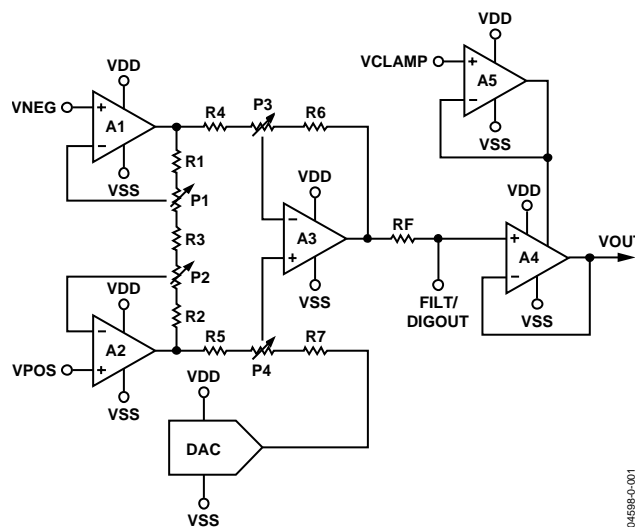

Figure 49. AD8555 Functional Schematic

GAIN VALUES

Table 6. First Stage Gain vs. Gain Code

| First Stage Gain Code | First Stage Gain | First Stage Gain Code | First Stage Gain | First Stage Gain Code | First Stage Gain | First Stage Gain Code | First Stage Gain |
|-----------------------|------------------|-----------------------|------------------|-----------------------|------------------|-----------------------|------------------|
| 0 | 4.000 | 32 | 4.503 | 64 | 5.069 | 96 | 5.706 |
| 1 | 4.015 | 33 | 4.520 | 65 | 5.088 | 97 | 5.727 |
| 2 | 4.030 | 34 | 4.536 | 66 | 5.107 | 98 | 5.749 |
| 3 | 4.045 | 35 | 4.553 | 67 | 5.126 | 99 | 5.770 |
| 4 | 4.060 | 36 | 4.570 | 68 | 5.145 | 100 | 5.791 |
| 5 | 4.075 | 37 | 4.587 | 69 | 5.164 | 101 | 5.813 |
| 6 | 4.090 | 38 | 4.604 | 70 | 5.183 | 102 | 5.834 |
| 7 | 4.105 | 39 | 4.621 | 71 | 5.202 | 103 | 5.856 |
| 8 | 4.120 | 40 | 4.638 | 72 | 5.221 | 104 | 5.878 |
| 9 | 4.135 | 41 | 4.655 | 73 | 5.241 | 105 | 5.900 |
| 10 | 4.151 | 42 | 4.673 | 74 | 5.260 | 106 | 5.921 |
| 11 | 4.166 | 43 | 4.690 | 75 | 5.280 | 107 | 5.943 |
| 12 | 4.182 | 44 | 4.707 | 76 | 5.299 | 108 | 5.965 |
| 13 | 4.197 | 45 | 4.725 | 77 | 5.319 | 109 | 5.988 |
| 14 | 4.213 | 46 | 4.742 | 78 | 5.339 | 110 | 6.010 |
| 15 | 4.228 | 47 | 4.760 | 79 | 5.358 | 111 | 6.032 |
| 16 | 4.244 | 48 | 4.778 | 80 | 5.378 | 112 | 6.054 |
| 17 | 4.260 | 49 | 4.795 | 81 | 5.398 | 113 | 6.077 |
| 18 | 4.276 | 50 | 4.813 | 82 | 5.418 | 114 | 6.099 |
| 19 | 4.291 | 51 | 4.831 | 83 | 5.438 | 115 | 6.122 |
| 20 | 4.307 | 52 | 4.849 | 84 | 5.458 | 116 | 6.145 |
| 21 | 4.323 | 53 | 4.867 | 85 | 5.479 | 117 | 6.167 |
| 22 | 4.339 | 54 | 4.885 | 86 | 5.499 | 118 | 6.190 |
| 23 | 4.355 | 55 | 4.903 | 87 | 5.519 | 119 | 6.213 |
| 24 | 4.372 | 56 | 4.921 | 88 | 5.540 | 120 | 6.236 |
| 25 | 4.388 | 57 | 4.939 | 89 | 5.560 | 121 | 6.259 |
| 26 | 4.404 | 58 | 4.958 | 90 | 5.581 | 122 | 6.283 |
| 27 | 4.420 | 59 | 4.976 | 91 | 5.602 | 123 | 6.306 |
| 28 | 4.437 | 60 | 4.995 | 92 | 5.622 | 124 | 6.329 |
| 29 | 4.453 | 61 | 5.013 | 93 | 5.643 | 125 | 6.353 |
| 30 | 4.470 | 62 | 5.032 | 94 | 5.664 | 126 | 6.376 |
| 31 | 4.486 | 63 | 5.050 | 95 | 5.685 | 127 | 6.400 |

$$GAIN1 \approx 4 \times \left(\frac{6.4}{4} \right)^{\left(\frac{Code}{127} \right)} \quad (3)$$

Table 7. Second Stage Gain and Gain Ranges vs. Gain Code

| Second Stage Gain Code | Second Stage Gain | Minimum Combined Gain | Maximum Combined Gain |
|------------------------|-------------------|-----------------------|-----------------------|
| 0 | 17.5 | 70 | 112 |
| 1 | 25 | 100 | 160 |
| 2 | 35 | 140 | 224 |
| 3 | 50 | 200 | 320 |
| 4 | 70 | 280 | 448 |
| 5 | 100 | 400 | 640 |
| 6 | 140 | 560 | 896 |
| 7 | 200 | 800 | 1280 |

OPEN WIRE FAULT DETECTION

The inputs to A1 and A2, VNEG and VPOS, each have a comparator to detect whether VNEG or VPOS exceeds a threshold voltage, nominally $VDD - 1.1\text{ V}$. If ($VNEG > VDD - 1.1\text{ V}$) or ($VPOS > VDD - 1.1\text{ V}$), VOUT is clamped to VSS. The output current limit circuit is disabled in this mode, but the maximum sink current is approximately 50 mA when $VDD = 5\text{ V}$. The inputs to A1 and A2, VNEG and VPOS, are also pulled up to VDD by currents IP1 and IP2. These are both nominally 18 nA and matched to within 5 nA. If the inputs to A1 or A2 are accidentally left floating, e.g., an open wire fault, IP1 and IP2 pull them to VDD, which would cause VOUT to swing to VSS, allowing this fault to be detected. It is not possible to disable IP1 and IP2, nor the clamping of VOUT to VSS, when VNEG or VPOS approaches VDD.

SHORTED WIRE FAULT DETECTION

The AD8555 provides fault detection, in the case where VPOS, VNEG, or VCLAMP shorts to VDD and VSS. Figure 50 shows the voltage regions at VPOS, VNEG, and VCLAMP that trigger an error condition. When an error condition occurs, the VOUT pin is shorted to VSS. Table 8 lists the voltage levels shown in Figure 50.

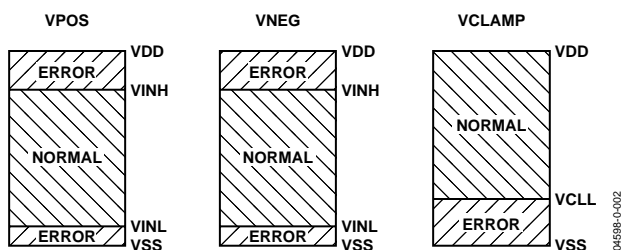

Figure 50. Voltage Regions at VPOS, VNEG, and VCLAMP That Trigger a Fault Condition

Table 8. Typical VINL, VINH, and VCLL Values ($VDD = 5\text{ V}$)

| Voltage | Typical Min | Typical Max | Purpose |
|---------|-------------|-------------|---------------------------------|
| VINH | 3.9 V | 4.2 V | Short to VDD Fault Detection |
| VINL | 0.195 V | 0.55 V | Short to VSS Fault Detection |
| VCLL | 1 V | 1.2 V | Short to VSS Fault Detection |

FLOATING VPOS, VNEG, OR VCLAMP FAULT DETECTION

A floating fault condition at the VPOS, VNEG, or VCLAMP pins is detected by using a low current to pull a floating input into an error voltage range, which is defined in the previous section. In this way, the VOUT pin is shorted to VSS when a floating input is detected. Table 9 lists the currents used.

Table 9. Floating Fault Detection at VPOS, VNEG, and VCLAMP

| Pin | Typical Current | Goal of Current |
|--------|-----------------------------|------------------------|
| VPOS | 16 nA pull-up | Pull VPOS above VINH |
| VNEG | 16 nA pull-up | Pull VNEG above VINH |
| VCLAMP | 0.2 μA pull-down | Pull VCLAMP below VCLL |

DEVICE PROGRAMMING

Digital Interface

The digital interface allows the first stage gain, second stage gain, and output offset to be adjusted and allows desired values for these parameters to be permanently stored by selectively blowing polysilicon fuses. To minimize pin count and board space, a single-wire digital interface is used. The digital input pin, DIGIN, has hysteresis to minimize the possibility of inadvertent triggering with slow signals. It also has a pull-down current sink to allow it to be left floating when programming is not being performed. The pull-down ensures inactive status of the digital input by forcing a dc low voltage on DIGIN.

A short pulse at DIGIN from low to high and back to low again, e.g., between 50 ns and 10 μs long, loads a 0 into a shift register. A long pulse at DIGIN, e.g., 50 μs or longer, loads a 1 into the shift register. The time between pulses should be at least 10 μs . Assuming $VSS = 0\text{ V}$, voltages at DIGIN between VSS and $0.2 \times VDD$ are recognized as a low, and voltages at DIGIN between $0.8 \times VDD$ and VDD are recognized as a high. A timing diagram example showing the waveform for entering code 010011 into the shift register is shown in Figure 51.

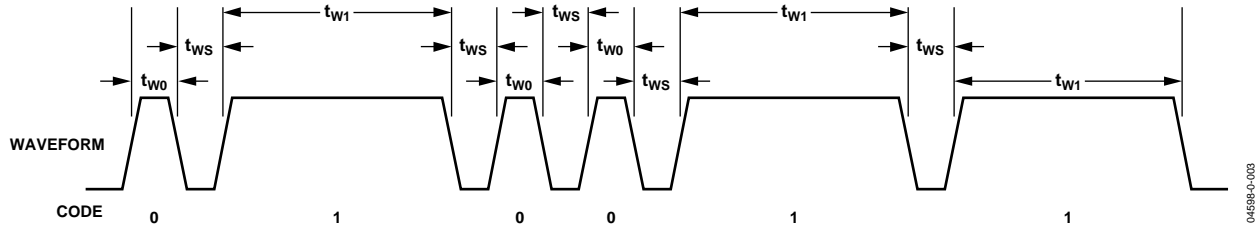

Figure 51. Timing Diagram for Code 010011

Table 10. Timing Specifications

| Timing Parameter | Description | Specification |
|------------------|---|------------------------------|
| t_{w0} | Pulse Width for Loading 0 into Shift Register | Between 50 ns and 10 μ s |
| t_{w1} | Pulse Width for Loading 1 into Shift Register | $\geq 50 \mu$ s |
| t_{ws} | Width between Pulses | $\geq 10 \mu$ s |

Table 11. 38-Bit Serial Word Format

| Field No. | Bits | Description |
|-----------|---------------|---|
| Field 0 | Bits 0 to 11 | 12-Bit Start of Packet 1000 0000 0001 |
| Field 1 | Bits 12 to 13 | 2-Bit Function 00: Change Sense Current 01: Simulate Parameter Value 10: Program Parameter Value 11: Read Parameter Value |
| Field 2 | Bits 14 to 15 | 2-Bit Parameter 00: Second Stage Gain Code 01: First Stage Gain Code 10: Output Offset Code 11: Other Functions |
| Field 3 | Bits 16 to 17 | 2-Bit Dummy 10 |
| Field 4 | Bits 18 to 25 | 8-Bit Value Parameter 00 (Second Stage Gain Code): 3 LSBs Used Parameter 01 (First Stage Gain Code): 7 LSBs Used Parameter 10 (Output Offset Code): All 8 Bits Used Parameter 11 (Other Functions) Bit 0 (LSB): Master Fuse Bit 1: Fuse for Production Test at Analog Devices Bit 2: Parity Fuse |
| Field 5 | Bits 26 to 37 | 12-Bit End of Packet 0111 1111 1110 |

A 38-bit serial word is used, divided into 6 fields. Assuming each bit can be loaded in 60 μ s, the 38-bit serial word transfers in 2.3 ms. Table 11 summarizes the word format.

Fields 0 and 5 are the start of packet and end of packet field, respectively. Matching the start of packet field with 1000 0000 0001 and the end of packet field with 0111 1111 1110 ensures that the serial word is valid and enables decoding of the other fields. Field 3 breaks up the data and ensures that no data combination can inadvertently trigger the start of packet and end of packet fields. Field 0 should be written first and Field 5 written last. Within each field, the MSB must be written first and the LSB written last. The shift register features power-on reset to minimize the risk of inadvertent programming; power-on reset occurs when VDD is between 0.7 V and 2.2 V.

Initial State

Initially, all the polysilicon fuses are intact. Each parameter has the value 0 assigned (see Table 12).

Table 12. Initial State before Programming

| Second Stage Gain Code = 0 | Second Stage Gain = 17.5 |
|----------------------------|--------------------------|
| First Stage Gain Code = 0 | First Stage Gain = 4.0 |
| Output Offset Code = 0 | Output Offset = VSS |
| Master Fuse = 0 | Master Fuse Not Blown |

When power is applied to a device, parameter values are taken either from internal registers if the master fuse is not blown or from the polysilicon fuses if the master fuse is blown.

Programmed values have no effect until the master fuse is blown. The internal registers feature power-on reset so that unprogrammed devices enter a known state after power-up; power-on reset occurs when VDD is between 0.7 V and 2.2 V.

Simulation Mode

The simulation mode allows any parameter to be changed temporarily. These changes are retained until the simulated value is reprogrammed, the power is removed, or the master fuse is blown. Parameters are simulated by setting Field 1 to 01, selecting the desired parameter in Field 2, and the desired value for the parameter in Field 4. Note that a value of 11 for Field 2 is ignored during the simulation mode. Examples of temporary settings follow:

- By setting the second stage gain code (Parameter 00) to 011 and the second stage gain to 50, 1000 0000 0001 01 00 10 0000 0011 0111 1111 1110 is the result.
- By setting the first stage gain code (Parameter 01) to 000 1011 and the first stage gain to 4.166, 1000 0000 0001 01 01 10 0000 1011 0111 1111 1110 is the result.

A first stage gain of 4.166 with a second stage gain of 50 gives a total gain of 208.3. This gain has a maximum tolerance of 2.5%.

- Set the output offset code (Parameter 10) to 0100 0000 and the output offset to 1.260 V when VDD = 5 V and VSS = 0 V. This output offset has a maximum tolerance of 0.8%: 1000 0000 0001 01 10 10 0100 0000 0111 1111 1110.

Programming Mode

Intact fuses give a bit value of 0. Bits with a desired value of 1 need to have the associated fuse blown. Since a relatively large current is needed to blow a fuse, only one fuse can be reliably blown at a time. Thus, a given parameter value may need several 38-bit words to allow reliable programming. A 5.5 V supply is required when blowing fuses to minimize the on resistance of the internal MOS switches that blow the fuse. The power supply must be able to deliver 250 mA of current, and at least 0.1 μ F of decoupling capacitance is needed across the power pins of the device. A minimum period of 1 ms should be allowed for each

fuse to blow. There is no need to measure the supply current during programming; the best way to verify correct programming is to use the read mode to read back the programmed values and to remeasure the gain and offset to verify these values. Programmed fuses have no effect on the gain and output offset until the master fuse is blown; after blowing the master fuse, the gain and output offset are determined solely by the blown fuses and the simulation mode is permanently deactivated.

Parameters are programmed by setting Field 1 to 10, selecting the desired parameter in Field 2, and selecting a single bit with the value 1 in Field 4.

As an example, suppose the user wants to permanently set the second stage gain to 50. Parameter 00 needs to have the value 0000 0011 assigned. Two bits have the value 1, so two fuses need to be blown. Since only one fuse can be blown at a time, the code 1000 0000 0001 10 00 10 0000 0010 0111 1111 1110 can be used to blow one fuse. The MOS switch that blows the fuse closes when the complete packet is recognized and opens when the start-of-packet, dummy, or end-of-packet fields are no longer valid. After 1 ms, the second code 1000 0000 0001 10 00 10 0000 0001 0111 1111 1110 can be entered to blow the second fuse.

To set the first stage gain permanently to a nominal value of 4.151, Parameter 01 needs to have the value 000 1011 assigned. Three fuses need to be blown, and the following codes can be used, with a 1 ms delay after each code:

```
1000 0000 0001 10 01 10 0000 1000 0111 1111 1110
1000 0000 0001 10 01 10 0000 0010 0111 1111 1110
1000 0000 0001 10 01 10 0000 0001 0111 1111 1110
```

To set the output offset permanently to a nominal value of 1.260 V when VDD = 5 V and VSS = 0 V, Parameter 10 needs to have the value 0100 0000 assigned. One fuse needs to be blown, and the following code can be used: 1000 0000 0001 10 10 10 0100 0000 0111 1111 1110.

Finally, to blow the master fuse to deactivate the simulation mode and prevent further programming, the code 1000 0000 0001 10 11 10 0000 0001 0111 1111 1110 can be used.

There are a total of 20 programmable fuses. Since each fuse requires 1 ms to blow, and each serial word can be loaded in 2.3 ms, the maximum time needed to program the fuses can be as low as 66 ms.

Parity Error Detection

A parity check is used to determine whether the programmed data of an AD8555 is valid, or whether data corruption has occurred in the nonvolatile memory. Figure 52 shows the schematic implemented in the AD8555.

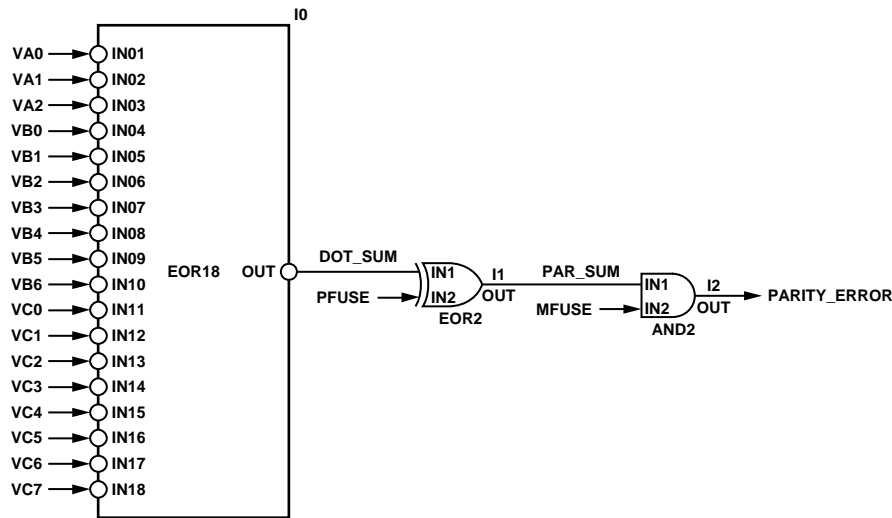

Figure 52. Functional Circuit of AD8555 Parity Check

Table 13. Examples of DAT_SUM

| Second Stage Gain Code | First Stage Gain Code | Output Offset Code | Number of Bits with 1 | DAT_SUM |
|------------------------|-----------------------|--------------------|-----------------------|---------|
| 000 | 000 0000 | 0000 0000 | 0 | 0 |
| 000 | 000 0000 | 1000 0000 | 1 | 1 |
| 000 | 000 0000 | 1000 0001 | 2 | 0 |
| 000 | 000 0001 | 0000 0000 | 1 | 1 |
| 000 | 100 0001 | 0000 0000 | 2 | 0 |
| 001 | 000 0000 | 0000 0000 | 1 | 1 |
| 001 | 000 0001 | 1000 0000 | 3 | 1 |
| 111 | 111 1111 | 1111 1111 | 18 | 0 |

VA0 to VA2 is the 3-bit control signal for the second stage gain, VB0 to VB6 is the 7-bit control signal for the first stage gain, and VC0 to VC7 is the 8-bit control signal for the output offset. PFUSE is the signal from the parity fuse, and MFUSE is the signal from the master fuse.

The function of the 2-input AND gate (cell and2) is to ignore the output of the parity circuit (signal PAR_SUM) when the master fuse has not been blown. PARITY_ERROR is set to 0 when MFUSE = 0. In the simulation mode, for example, parity check is disabled. After the master fuse has been blown, i.e., after the AD8555 has been programmed, the output from the parity circuit (signal PAR_SUM) is fed to PARITY_ERROR.

When PARITY_ERROR is 0, the AD8555 behaves as a programmed amplifier. When PARITY_ERROR is 1, a parity error has been detected, and VOUT is connected to VSS.

The 18-bit data signal (VA0 to VA2, VB0 to VB6, and VC0 to VC7) is fed to an 18-input exclusive-OR gate (Cell EOR18). The output of Cell EOR18 is the signal DAT_SUM. DAT_SUM = 0 if there is an even number of 1s in the 18-bit word; DAT_SUM = 1 if there is an odd number of 1s in the 18-bit word. Examples are given in Table 13.

After the second stage gain, first stage gain, and output offset have been programmed, DAT_SUM should be computed and the parity bit should be set equal to DAT_SUM. If DAT_SUM is 0, the parity fuse *should not* be blown in order for the PFUSE signal to be 0. If DAT_SUM is 1, the parity fuse should be blown to set the PFUSE signal to 1. The code to blow the parity fuse is 1000 0000 0001 10 11 10 0000 0100 0111 1111 1110.

After setting the parity bit, the master fuse can be blown to prevent further programming, using the code 1000 0000 0001 10 11 10 0000 0001 0111 1111 1110.

Signal PAR_SUM is the output of the 2-input exclusive-OR gate (Cell EOR2). After the master fuse has been blown, PARITY_ERROR is set to PAR_SUM. As mentioned earlier, the AD8555 behaves as a programmed amplifier when PARITY_ERROR = 0 (no parity error). On the other hand, VOUT is connected to VSS when a parity error has been detected, i.e., when PARITY_ERROR = 1.

Read Mode

The values stored by the polysilicon fuses can be sent to the FILT/DIGOUT pin to verify correct programming. Normally, the FILT/DIGOUT pin is connected to only the second gain stage output via RF. During read mode, however, the FILT/DIGOUT pin is also connected to the output of a shift register to allow the polysilicon fuse contents to be read. Since VOUT is a buffered version of FILT/DIGOUT, VOUT also outputs a digital signal during read mode.

Read mode is entered by setting Field 1 to 11 and selecting the desired parameter in Field 2; Field 4 is ignored. The parameter value, stored in the polysilicon fuses, is loaded into an internal shift register, and the MSB of the shift register is connected to the FILT/DIGOUT pin. Pulses at DIGIN shift the shift register contents out to the FILT/DIGOUT pin, allowing the 8-bit parameter value to be read after seven additional pulses; shifting occurs on the falling edge of DIGIN. An eighth pulse at DIGIN disconnects FILT/DIGOUT from the shift register and terminates the read mode. If a parameter value is less than 8 bits long, the MSBs of the shift register are padded with 0s.

For example, to read the second stage gain, the code 1000 0000 0001 11 00 10 0000 0000 0111 1111 1110 can be used. Since the second stage gain parameter value is only three bits long, the FILT/DIGOUT pin has a value of 0 when this code is entered and remains 0 during four additional pulses at DIGIN. The fifth, sixth, and seventh pulse at DIGIN returns the 3-bit value at FILT/DIGOUT, the seventh pulse returning the LSB. An eighth pulse at DIGIN terminates the read mode.

Sense Current

A sense current is sent across each polysilicon fuse to determine whether it has been blown or not. When the voltage across the fuse is less than approximately 1.5 V, the fuse is considered not blown and Logic 0 is output from the OTP cell. When the voltage across the fuse is greater than approximately 1.5 V, the fuse is considered blown and Logic 1 is output.

When the AD8555 is manufactured, all fuses have a low resistance. When a sense current is sent through the fuse, a voltage less than 0.1 V is developed across the fuse. This is much lower than 1.5 V, so Logic 0 is output from the OTP cell. When a fuse is electrically blown, it should have a very high resistance. When the sense current is applied to the blown fuse, the voltage across the fuse should be larger than 1.5 V, so Logic 1 is output from the OTP cell.

It is theoretically possible (though very unlikely) for a fuse to be incompletely blown during programming, assuming the required conditions are met. In this situation, the fuse could have a medium resistance (neither low nor high), and a voltage of approximately 1.5 V could be developed across the fuse. Thus, the OTP cell could sometimes output Logic 0 or a Logic 1, depending on temperature, supply voltage, and other variables. To detect this undesirable situation, the sense current can be lowered by a factor of 4 using a special code. The voltage developed across the fuse would then change from 1.5 V to 0.38 V, and the output of the OTP would be a Logic 0 instead of the Logic 1 expected from a blown fuse. Correctly blown fuses would still output a Logic 1. In this way, incorrectly blown fuses can be detected. Another special code would return the sense current to the normal (larger) value. The sense current cannot be permanently programmed to the low value. When the AD8555 is powered up, the sense current defaults to the high value.

The code to use the low sense current is 1000 0000 0001 00 00 10 XXXX XXX1 0111 1111 1110.

The code to use the normal (high) sense current is 1000 0000 0001 00 00 10 XXXX XXX0 0111 1111 1110.

Suggested Programming Procedure

1. Set VDD and VSS to the desired values in the application. Use simulation mode to test and determine the desired codes for the second stage gain, first stage gain, and output offset. The nominal values for these parameters are shown in Table 6, Table 7, Equation 1, and Equation 2; the codes corresponding to these values can be used as a starting point. However, since actual parameter values for given codes vary from device to device, some fine tuning is necessary for the best possible accuracy.

One way to choose these values is to set the output offset to an approximate value, e.g., Code 128 for midsupply, to allow the required gain to be determined. Then set the second stage gain such that the minimum first stage gain (Code 0) gives a lower gain than required, and the maximum first stage gain (Code 127) gives a higher gain than required. After choosing the second stage gain, the first stage gain can be chosen to fine tune the total gain. Finally, the output offset can be adjusted to give the desired value. After determining the desired codes for second stage gain, first stage gain, and output offset, the device is ready for permanent programming.

2. Set VSS to 0 V and VDD to 5.5 V. Use program mode to permanently enter the desired codes for the second stage gain, first stage gain, and output offset. Blow the master fuse to allow the AD8555 to read data from the fuses and to prevent further programming.
3. Set VDD and VSS to the desired values in the application. Use read mode with low sense current followed by high sense current to verify programmed codes.
4. Measure gain and offset to verify correct functionality.

Suggested Algorithm to Determine Optimal Gain and Offset Codes

1. Determine the desired gain, G_A (e.g., using measurements).
- 2a. Use Table 7 to determine the second stage gain G_2 such that $(4.00 \times 1.04) < (G_A/G_2) < (6.4/1.04)$. This ensures that the first and last codes for the first stage gain are not used, thereby allowing enough first stage gain codes within each second stage gain range to adjust for the 3% accuracy.
- 2b. Use simulation mode to set the second stage gain to G_2 .
- 3a. Set the output offset to allow the AD8555 gain to be measured, e.g., use Code 128 to set it to midsupply.
- 3b. Use Table 6 or Equation 3 to set the first stage gain code C_{G1} such that the first stage gain is nominally G_A/G_2 .
- 3c. Measure the resulting gain G_B . G_B should be within 3% of G_A .
- 3d. Calculate the first stage gain error (in relative terms) $E_{G1} = G_B/G_A - 1$.
- 3e. Calculate the error (in the number of the first stage gain codes) $C_{EG1} = E_{G1}/0.00370$.
- 3f. Set the first stage gain code to $C_{G1} - C_{EG1}$.
- 3g. Measure the gain G_C . G_C should be closer to G_A than to G_B .
- 3h. Calculate the error (in relative terms) $E_{G2} = G_C/G_A - 1$.
- 3i. Calculate the error (in the number of the first stage gain codes) $C_{EG2} = E_{G2}/0.00370$.
- 3j. Set the first stage gain code to $C_{G1} - C_{EG1} - C_{EG2}$. The resulting gain should be within one code of G_A .
- 4a. Determine the desired output offset O_A , e.g., using the measurements.
- 4b. Use Equation 1 to set the output offset code C_{O1} such that the output offset is nominally O_A .
- 4c. Measure the output offset O_B . O_B should be within 3% of O_A .
- 4d. Calculate the error (in relative terms) $E_{O1} = O_B/O_A - 1$.
- 4e. Calculate the error (in the number of the output offset codes) $C_{EO1} = E_{O1}/0.00392$.
- 4f. Set the output offset code to $C_{O1} - C_{EO1}$.
- 4g. Measure the output offset O_C . O_C should be closer to O_A than to O_B .
- 4h. Calculate the error (in relative terms) $E_{O2} = O_C/O_A - 1$.
- 4i. Calculate the error (in the number of the output offset codes) $C_{EO2} = E_{O2}/0.00392$.
- 4j. Set the output offset code to $C_{O1} - C_{EO1} - C_{EO2}$. The resulting offset should be within one code of O_A .

FILTERING FUNCTION

The AD8555's FILT/DIGOUT pin can be used to create a simple low-pass filter. The AD8555's internal 18 kΩ resistor can be used with an external capacitor for this purpose. Typical responses of the AD8555, configured for a gain of 70 and gain of 1280, are shown in Figure 54 and Figure 55, respectively. This filtering feature can be used to pass the signals within the filter's pass band while limiting the out-of-band signals bandwidth and, therefore, reducing the noise of the overall solution.

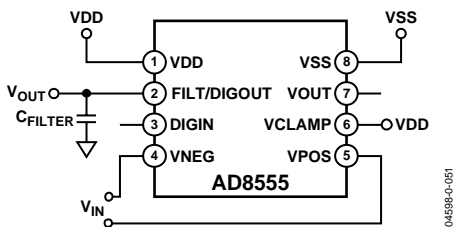

Figure 53. AD8555 Configured to Filter Noise

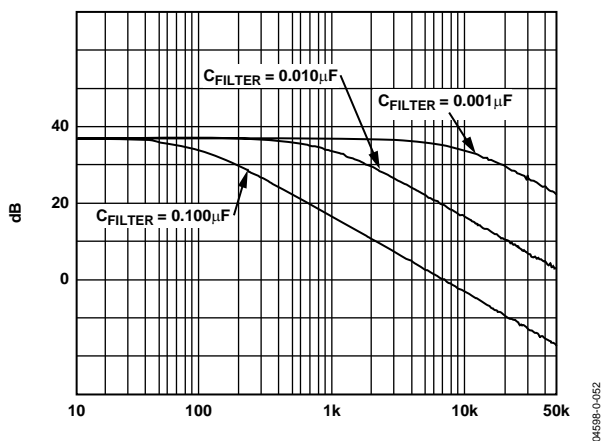

Figure 54. Typical Response of the AD8555 at FILT/DIGOUT Pin (Gain = 70)

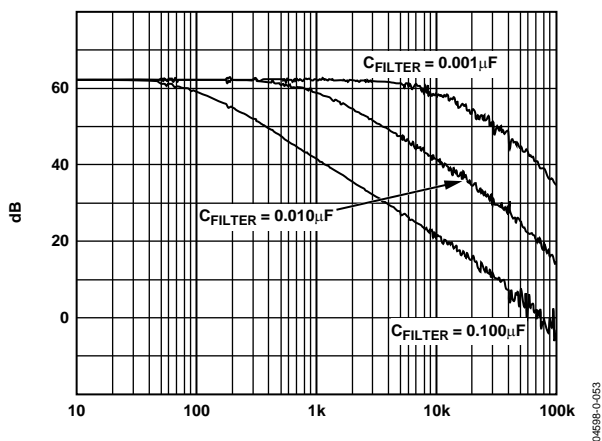

Figure 55. Typical Response of the AD8555 at FILT/DIGOUT Pin (Gain = 1280)

DRIVING CAPACITIVE LOADS

The AD8555 can drive large capacitive loads. This feature is useful when the amplifier, placed close to the sensor, has to drive long cables. Most instrumentation amplifiers have difficulty driving capacitance due to the degradation of the phase margin caused by the additional phase lag from the capacitive load. Higher capacitance at the output can increase the amount of overshoot and ringing in the amplifier's step response and could even affect the stability of the device. Additionally, the value of the capacitive load that an amplifier can drive before oscillation varies with gain, supply voltage, input signal, and temperature. Figure 57 and Figure 58 show the overshoot response of AD8555 versus the capacitive load with a different value isolation resistor (R_S) in Figure 56. Similar to all amplifiers, the AD8555 responds with overshoot when driving large C_L , but after a point (approximately 22 nF), the overshoot decreases. This is because the pole created by C_L dominates at first; however, at some point, the pole is farther in than the pole setting of the buffer amplifier and is ignored by AD8555.

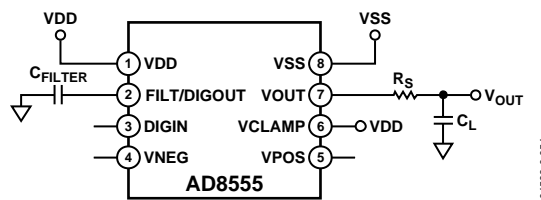

Figure 56. Test Circuit for Driving Capacitive Loads

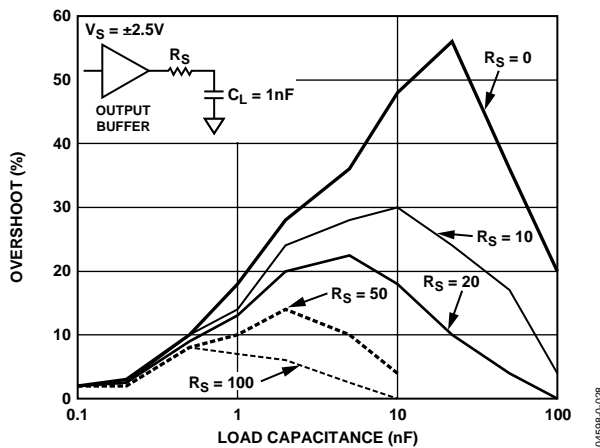

Figure 57. Positive Overshoot Graph vs. C_L

AD8555

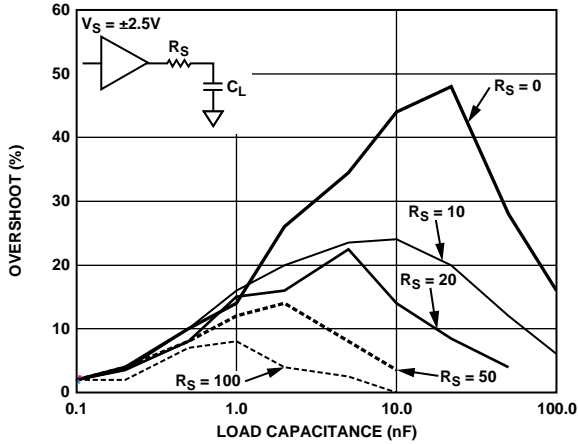

Figure 58. Negative Overshoot Graph vs. C_L

needed to maintain common-mode rejection at low frequencies. This introduces a second low-pass network, $R_1 + R_2$ and C_3 that has a -3 dB frequency equal to $1/(2\pi \times (R_1 + R_2)(C_3))$. This circuit's -3 dB signal bandwidth is approximately 4 kHz when a C_3 value of $0.047 \mu\text{F}$ is used (see Figure 59).

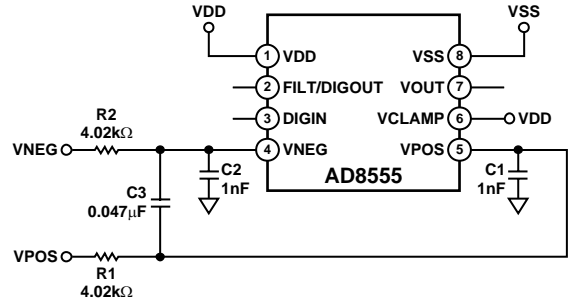

Figure 59. RFI Suppression Method

RF INTERFERENCE

All instrumentation amplifiers show dc offset as the result of rectification of high frequency out-of-band signals that appear at their inputs. The circuit in Figure 59 provides good RFI suppression without reducing performance within the AD8555 pass band. Resistor R_1 and Capacitor C_1 , and likewise Resistor R_2 and Capacitor C_2 , form a low-pass RC filter that has a -3 dB bandwidth equal to $f_{(-3 \text{ dB})} = 1/2\pi \times R_1 \times C_1$. It can be seen that R_1 , R_2 and C_1 , C_2 form a bridge circuit whose output appears across the amplifier's input pins. Any mismatch between C_1 , C_2 unbalances the bridge and reduce the common-mode rejection. Using the component values shown, this filter has a bandwidth of approximately 40 kHz. To preserve common-mode rejection in the AD8555's pass band, capacitors need to be 5% (silver mica) or better and should be placed as close to its inputs as possible. Resistors should be 1% metal film. Capacitor C_3 is

SINGLE-SUPPLY DATA ACQUISITION SYSTEM

Interfacing bipolar signals to single-supply analog-to-digital converters (ADCs) presents a challenge. The bipolar signal must be mapped into the input range of the ADC. Figure 60 shows how this translation can be achieved. The output offset can be programmed to a desirable level to accommodate the input voltage requirement of the ADC.

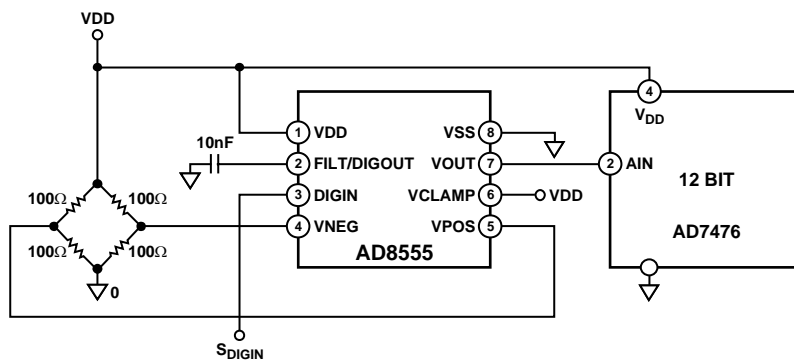

Figure 60. A Single-Supply Data Acquisition Circuit Using the AD8555

The bridge circuit with a sensitivity of 2 mV/V is excited by a 5 V supply. The full-scale output voltage from the bridge (± 10 mV) therefore has a common-mode level of 2.5 V. The AD8555 removes the common-mode component and amplifies the input signal by a factor of 200 ($G_1 = 4$, $G_2 = 50$, Offset = 128). This results in an output signal of ± 2.0 V. In order to prevent this signal from running into the AD8555's ground rail, the output offset voltage has to be raised to 2.5 V. This signal is within the input voltage range of the ADC.

USING THE AD8555 WITH CAPACITIVE SENSORS

Figure 61 shows a crude way of using the AD8555 with capacitive sensors. R_{P1} and R_{P2} are resistors implementing a potential divider to bias VNEG to $V_{DD}/2$. Recommended values range from 1 k Ω to 1 M Ω . C_S is the capacitive sensor, and R_S is a shunt resistor used to prevent leakage currents from integrating on the sensor. The value of R_S is application specific.

Note that although VNEG is tied to a dc voltage, the only impedance across the capacitive sensor is R_S . Therefore, the only way for charge to leak away from C_S is through R_S , assuming the input bias currents at VPOS and VNEG are negligible.

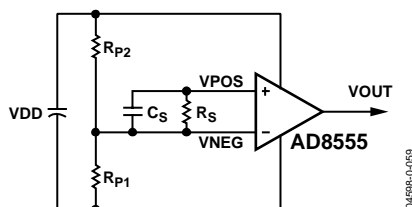

Figure 61. Crude Way of Using the AD8555 with Capacitive Sensors

The weakness of the circuit in Figure 61 is that the AD8555 input bias current at VPOS flows into R_S and creates a differen-

tial offset voltage between VPOS and VNEG. This differential offset voltage is amplified by the AD8555. The input bias current at VNEG, on the other hand, flows into R_{P1} and create a common-mode shift. This has little impact on VOUT. Despite this weakness, the arrangement in Figure 61 should work if the user wants to minimize the number of components around the sensor, and if the error introduced by the input bias current at VPOS is considered negligible.

If greater accuracy is needed, the circuit in Figure 62 is recommended. R_{P1} , R_{P2} , and C_S are the same as in Figure 61; R_{P1} and R_{P2} should be between 1 k Ω to 1 M Ω . R_S in Figure 61 has been split into two resistors, R_{S1} and R_{S2} , in Figure 62. Again, the only way for the capacitive sensor to discharge is through $(R_{S1} + R_{S2})$.

The input bias current at VPOS flows through R_{S2} and R_{P1} , and the input bias current at VNEG flows through R_{S1} and R_{P1} . If R_{S1} is made equal to R_{S2} and if the input bias currents are equal, the input bias currents give a common-mode shift at VPOS and VNEG with no differential offset. This common-mode shift is attenuated by the AD8555 common-mode rejection. Furthermore, changes in input bias current, e.g., with temperature, manifest as an input common-mode change, also rejected by the AD8555.

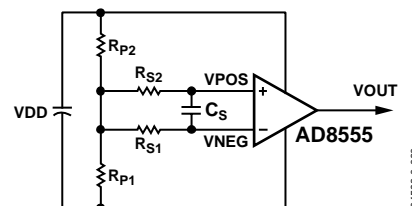
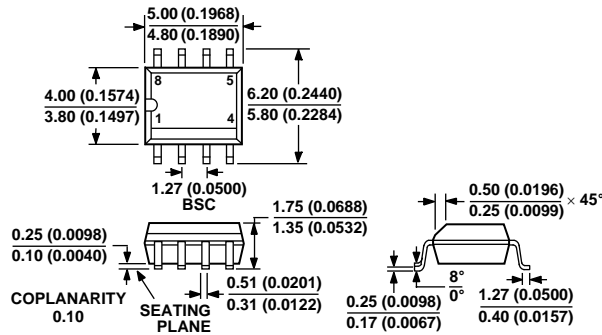

Figure 62. Recommended Way of Using the AD8555 with Capacitive Sensors

OUTLINE DIMENSIONS



COMPLIANT TO JEDEC STANDARDS MS-012AA
 CONTROLLING DIMENSIONS ARE IN MILLIMETERS; INCH DIMENSIONS
 (IN PARENTHESES) ARE ROUNDED-OFF MILLIMETER EQUIVALENTS FOR
 REFERENCE ONLY AND ARE NOT APPROPRIATE FOR USE IN DESIGN

Figure 63. 8-Lead Standard Small Outline Package [SOIC] Narrow Body (R-8)
 Dimensions shown in millimeters (inches)

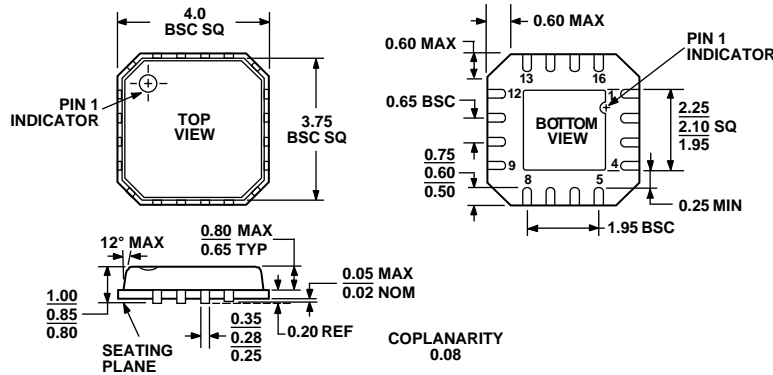

COMPLIANT TO JEDEC STANDARDS MO-220-VGGC

Figure 64. 16-Lead Lead Frame Chip Scale Package [LFCS] 4 mm x 4 mm Body (CP-16)
 Dimensions shown in millimeters

ORDERING GUIDE

| Model | Temperature Range | Package Description | Package Option |
|-----------------|-------------------|---------------------|----------------|
| AD8555AR | -40°C to +125°C | 8-Lead SOIC | R-8 |
| AD8555AR-REEL | -40°C to +125°C | 8-Lead SOIC | R-8 |
| AD8555AR-REEL7 | -40°C to +125°C | 8-Lead SOIC | R-8 |
| AD8555AR-EVAL | | Evaluation Board | |
| AD8555ACP-R2 | -40°C to +125°C | 16-Lead LFCSP | CP-16 |
| AD8555ACP-REEL | -40°C to +125°C | 16-Lead LFCSP | CP-16 |
| AD8555ACP-REEL7 | -40°C to +125°C | 16-Lead LFCSP | CP-16 |