

WARP2 SERIES IGBT WITH
ULTRAFAST SOFT RECOVERY DIODE

Applications

- Telecom and Server SMPS
- PFC and ZVS SMPS Circuits
- Uninterruptable Power Supplies
- Consumer Electronics Power Supplies

Features

- NPT Technology, Positive Temperature Coefficient
- Lower $V_{CE(SAT)}$
- Lower Parasitic Capacitances
- Minimal Tail Current
- HEXFRED Ultra Fast Soft-Recovery Co-Pack Diode
- Tighter Distribution of Parameters
- Higher Reliability

Benefits

- Parallel Operation for Higher Current Applications
- Lower Conduction Losses and Switching Losses
- Higher Switching Frequency up to 150kHz

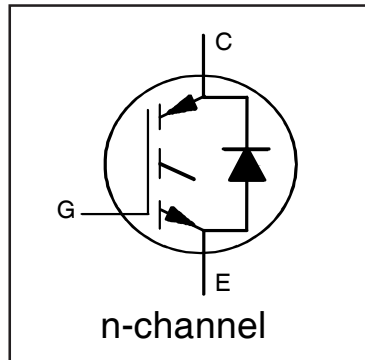

$V_{CES} = 600V$
 $V_{CE(on)} \text{ typ.} = 2.00V$
 @ $V_{GE} = 15V$ $I_C = 33A$

Equivalent MOSFET Parameters^①

$R_{CE(on)} \text{ typ.} = 61m\Omega$
 I_D (FET equivalent) = 50A

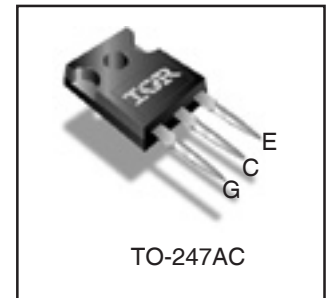

Absolute Maximum Ratings

| | Parameter | Max. | Units | |
|---------------------------|---|---------------------|------------|-----------------------------------|
| V_{CES} | Collector-to-Emitter Voltage | 600 | V | |
| $I_C @ T_C = 25^\circ C$ | Continuous Collector Current | 75 | A | |
| $I_C @ T_C = 100^\circ C$ | Continuous Collector Current | 45 | | |
| I_{CM} | Pulse Collector Current (Ref. Fig. C.T.4) | 150 | | |
| I_{LM} | Clamped Inductive Load Current ^② | 150 | | |
| $I_F @ T_C = 25^\circ C$ | Diode Continuous Forward Current | 40 | | |
| $I_F @ T_C = 100^\circ C$ | Diode Continuous Forward Current | 15 | | |
| I_{FRM} | Maximum Repetitive Forward Current ^③ | 60 | | |
| V_{GE} | Gate-to-Emitter Voltage | ± 20 | | V |
| $P_D @ T_C = 25^\circ C$ | Maximum Power Dissipation | 390 | | W |
| $P_D @ T_C = 100^\circ C$ | Maximum Power Dissipation | 156 | | |
| T_J | Operating Junction and | -55 to +150 | $^\circ C$ | |
| T_{STG} | Storage Temperature Range | | | |
| | Soldering Temperature for 10 sec. | | | 300 (0.063 in. (1.6mm) from case) |
| | Mounting Torque, 6-32 or M3 Screw | 10 lbf-in (1.1 N-m) | | |

Thermal Resistance

| | Parameter | Min. | Typ. | Max. | Units |
|-------------------------|--|------|------------|------|--------------|
| $R_{\theta JC}$ (IGBT) | Thermal Resistance Junction-to-Case-(each IGBT) | — | — | 0.32 | $^\circ C/W$ |
| $R_{\theta JC}$ (Diode) | Thermal Resistance Junction-to-Case-(each Diode) | — | — | 1.7 | |
| $R_{\theta CS}$ | Thermal Resistance, Case-to-Sink (flat, greased surface) | — | 0.50 | — | |
| $R_{\theta JA}$ | Thermal Resistance, Junction-to-Ambient (typical socket mount) | — | — | 40 | |
| | Weight | — | 6.0 (0.21) | — | g (oz) |

Electrical Characteristics @ T_J = 25°C (unless otherwise specified)

| | Parameter | Min. | Typ. | Max. | Units | Conditions | Ref.Fig |
|--|---|------|------|------|-------|--|------------|
| V _{(BR)CES} | Collector-to-Emitter Breakdown Voltage | 600 | — | — | V | V _{GE} = 0V, I _C = 500μA | |
| ΔV _{(BR)CES} /ΔT _J | Temperature Coeff. of Breakdown Voltage | — | 0.31 | — | V/°C | V _{GE} = 0V, I _C = 1mA (25°C-125°C) | |
| R _G | Internal Gate Resistance | — | 1.7 | — | Ω | 1MHz, Open Collector | |
| V _{CE(on)} | Collector-to-Emitter Saturation Voltage | — | 2.00 | 2.35 | V | I _C = 33A, V _{GE} = 15V | 4, 5,6,8,9 |
| | | — | 2.45 | 2.85 | | I _C = 50A, V _{GE} = 15V | |
| | | — | 2.60 | 2.95 | | I _C = 33A, V _{GE} = 15V, T _J = 125°C | |
| | | — | 3.20 | 3.60 | | I _C = 50A, V _{GE} = 15V, T _J = 125°C | |
| V _{GE(th)} | Gate Threshold Voltage | 3.0 | 4.0 | 5.0 | V | I _C = 250μA | 7,8,9 |
| ΔV _{GE(th)} /ΔT _J | Threshold Voltage temp. coefficient | — | -10 | — | mV/°C | V _{CE} = V _{GE} , I _C = 1.0mA | |
| g _{fe} | Forward Transconductance | — | 41 | — | S | V _{CE} = 50V, I _C = 33A, PW = 80μs | |
| I _{CES} | Collector-to-Emitter Leakage Current | — | 5.0 | 500 | μA | V _{GE} = 0V, V _{CE} = 600V | |
| | | — | 1.0 | — | mA | V _{GE} = 0V, V _{CE} = 600V, T _J = 125°C | |
| V _{FM} | Diode Forward Voltage Drop | — | 1.30 | 1.70 | V | I _F = 15A, V _{GE} = 0V | 10 |
| | | — | 1.20 | 1.60 | | I _F = 15A, V _{GE} = 0V, T _J = 125°C | |
| I _{GES} | Gate-to-Emitter Leakage Current | — | — | ±100 | nA | V _{GE} = ±20V, V _{CE} = 0V | |

Switching Characteristics @ T_J = 25°C (unless otherwise specified)

| | Parameter | Min. | Typ. | Max. | Units | Conditions | Ref.Fig | |
|----------------------------|---|-------------|------|------|-------|--|-------------|-----|
| Q _g | Total Gate Charge (turn-on) | — | 205 | 308 | nC | I _C = 33A | 17 | |
| Q _{gc} | Gate-to-Collector Charge (turn-on) | — | 70 | 105 | | V _{CC} = 400V | CT1 | |
| Q _{ge} | Gate-to-Emitter Charge (turn-on) | — | 30 | 45 | | V _{GE} = 15V | | |
| E _{on} | Turn-On Switching Loss | — | 255 | 305 | μJ | I _C = 33A, V _{CC} = 390V | CT3 | |
| E _{off} | Turn-Off Switching Loss | — | 375 | 445 | | V _{GE} = +15V, R _G = 3.3Ω, L = 200μH | | |
| E _{total} | Total Switching Loss | — | 630 | 750 | | T _J = 25°C ④ | | |
| t _{d(on)} | Turn-On delay time | — | 30 | 40 | ns | I _C = 33A, V _{CC} = 390V | CT3 | |
| t _r | Rise time | — | 10 | 15 | | V _{GE} = +15V, R _G = 3.3Ω, L = 200μH | | |
| t _{d(off)} | Turn-Off delay time | — | 130 | 150 | | T _J = 25°C ④ | | |
| t _f | Fall time | — | 11 | 15 | | | | |
| E _{on} | Turn-On Switching Loss | — | 580 | 700 | | I _C = 33A, V _{CC} = 390V | | CT3 |
| E _{off} | Turn-Off Switching Loss | — | 480 | 550 | μJ | V _{GE} = +15V, R _G = 3.3Ω, L = 200μH | 11,13 | |
| E _{total} | Total Switching Loss | — | 1060 | 1250 | | T _J = 125°C ④ | WF1,WF2 | |
| t _{d(on)} | Turn-On delay time | — | 26 | 35 | | I _C = 33A, V _{CC} = 390V | CT3 | |
| t _r | Rise time | — | 13 | 20 | ns | V _{GE} = +15V, R _G = 3.3Ω, L = 200μH | 12,14 | |
| t _{d(off)} | Turn-Off delay time | — | 146 | 165 | | T _J = 125°C ④ | WF1,WF2 | |
| t _f | Fall time | — | 15 | 20 | | | | |
| C _{ies} | Input Capacitance | — | 3648 | — | pF | V _{GE} = 0V | 16 | |
| C _{oes} | Output Capacitance | — | 322 | — | | V _{CC} = 30V | | |
| C _{res} | Reverse Transfer Capacitance | — | 56 | — | | f = 1Mhz | | |
| C _{oes eff.} | Effective Output Capacitance (Time Related) ⑤ | — | 215 | — | | V _{GE} = 0V, V _{CE} = 0V to 480V | | 15 |
| C _{oes eff. (ER)} | Effective Output Capacitance (Energy Related) ⑤ | — | 163 | — | | | | |
| RBSOA | Reverse Bias Safe Operating Area | FULL SQUARE | | | | T _J = 150°C, I _C = 150A V _{CC} = 480V, V _p = 600V R _g = 22Ω, V _{GE} = +15V to 0V | 3 CT2 | |
| t _{rr} | Diode Reverse Recovery Time | — | 42 | 60 | ns | T _J = 25°C I _F = 15A, V _R = 200V, | 19 | |
| | | — | 74 | 120 | | T _J = 125°C di/dt = 200A/μs | | |
| Q _{rr} | Diode Reverse Recovery Charge | — | 80 | 180 | nC | T _J = 25°C I _F = 15A, V _R = 200V, | 21 | |
| | | — | 220 | 600 | | T _J = 125°C di/dt = 200A/μs | | |
| I _{rr} | Peak Reverse Recovery Current | — | 4.0 | 6.0 | A | T _J = 25°C I _F = 15A, V _R = 200V, | 19,20,21,22 | |
| | | — | 6.5 | 10 | | T _J = 125°C di/dt = 200A/μs | | CT5 |

Notes:

① R_{CE(on)} typ. = equivalent on-resistance = V_{CE(on)} typ. / I_C, where V_{CE(on)} typ. = 2.00V and I_C = 33A. I_D (FET Equivalent) is the equivalent MOSFET I_D rating @ 25°C for applications up to 150kHz. These are provided for comparison purposes (only) with equivalent MOSFET solutions.

② V_{CC} = 80% (V_{CES}), V_{GE} = 20V, L = 28 μH, R_G = 22 Ω.

③ Pulse width limited by max. junction temperature.

④ Energy losses include "tail" and diode reverse recovery, Data generated with use of Diode 30ETH06.

⑤ C_{oes eff.} is a fixed capacitance that gives the same charging time as C_{oes} while V_{CE} is rising from 0 to 80% V_{CES}.

C_{oes eff. (ER)} is a fixed capacitance that stores the same energy as C_{oes} while V_{CE} is rising from 0 to 80% V_{CES}.

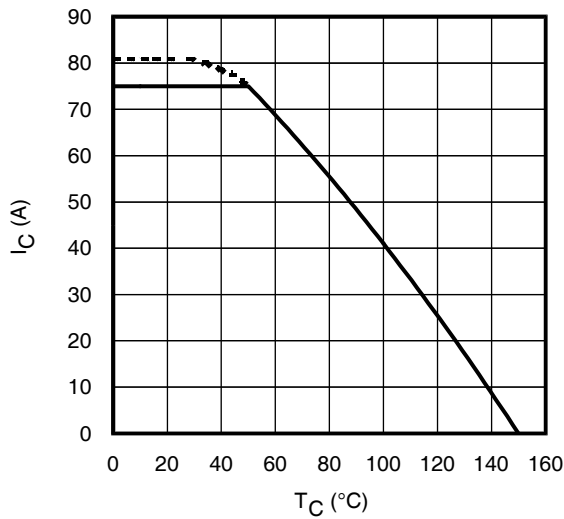

Fig. 1 - Maximum DC Collector Current vs. Case Temperature

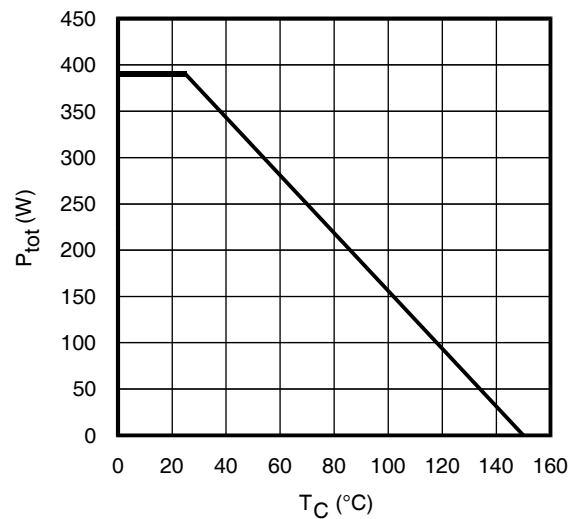

Fig. 2 - Power Dissipation vs. Case Temperature

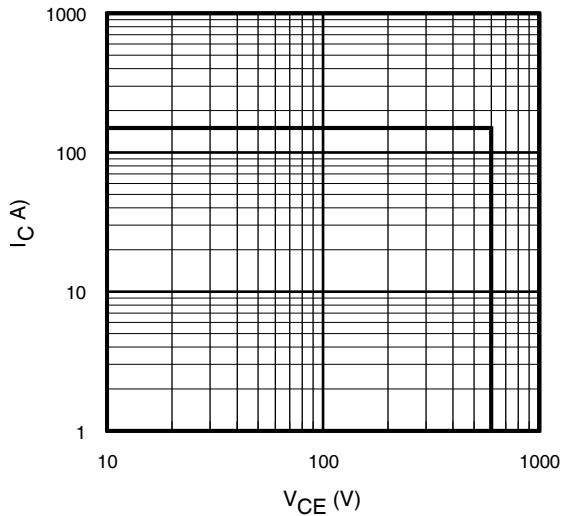

Fig. 3 - Reverse Bias SOA
 $T_J = 150^{\circ}C$; $V_{GE} = 15V$

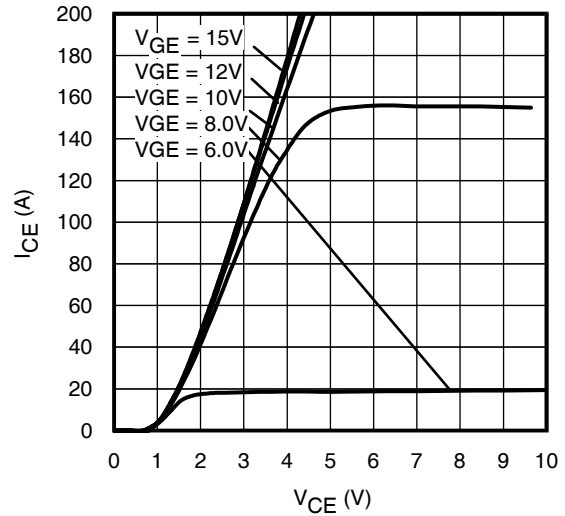

Fig. 4 - Typ. IGBT Output Characteristics
 $T_J = -40^{\circ}C$; $t_p = 80\mu s$

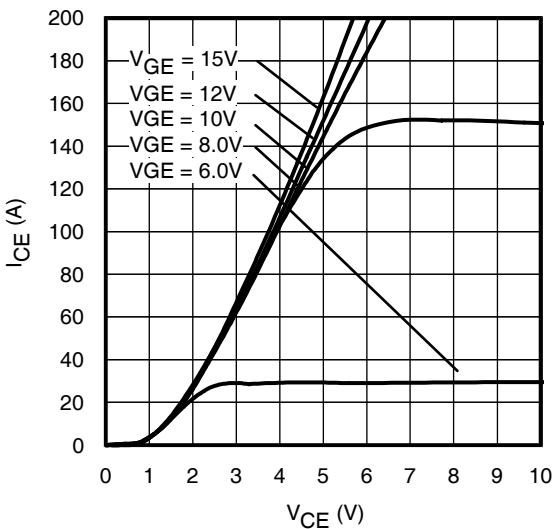

Fig. 5 - Typ. IGBT Output Characteristics
 $T_J = 25^{\circ}C$; $t_p = 80\mu s$

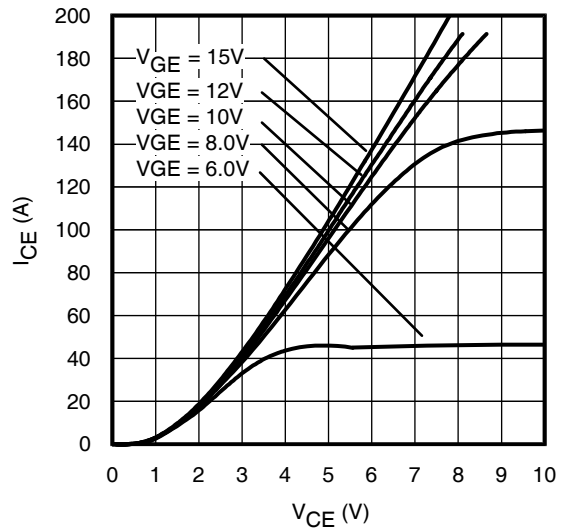

Fig. 6 - Typ. IGBT Output Characteristics
 $T_J = 125^{\circ}C$; $t_p = 80\mu s$

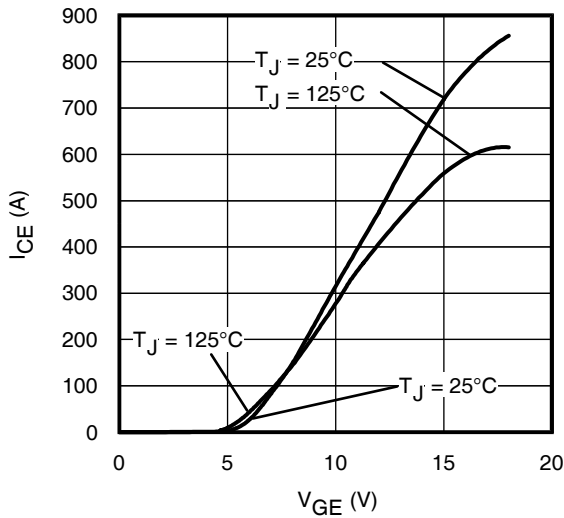

Fig. 7 - Typ. Transfer Characteristics
 $V_{CE} = 50V$; $t_p = 10\mu s$

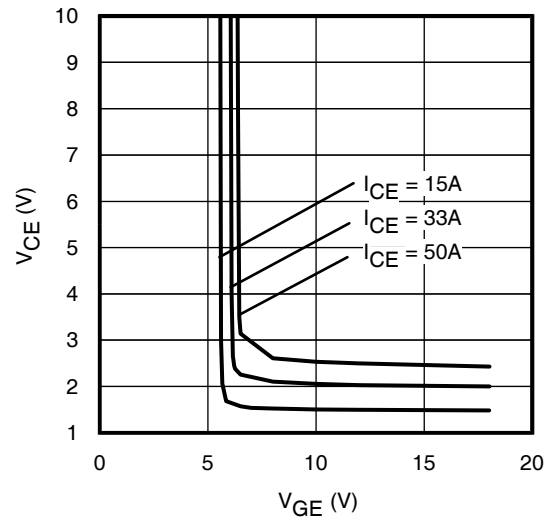

Fig. 8 - Typical V_{CE} vs. V_{GE}
 $T_J = 25^\circ C$

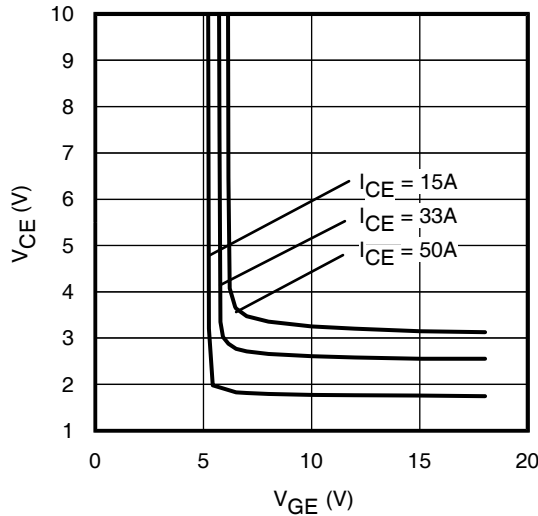

Fig. 9 - Typical V_{CE} vs. V_{GE}
 $T_J = 125^\circ C$

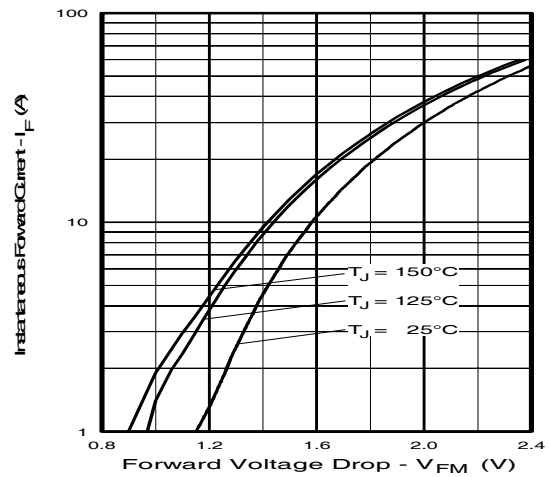

Fig. 10 - Maximum Diode Forward Characteristics
 $t_p = 80\mu s$

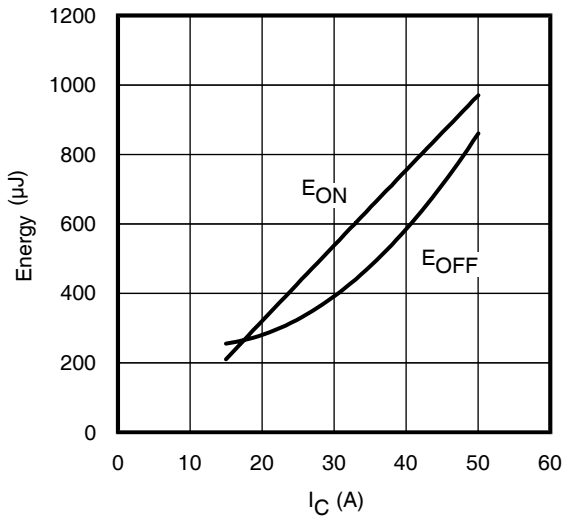

Fig. 11 - Typ. Energy Loss vs. I_C
 $T_J = 125^\circ C$; $L = 200\mu H$; $V_{CE} = 390V$; $R_G = 3.3\Omega$; $V_{GE} = 15V$.
Diode clamp used: 30ETH06 (See C.T.3)

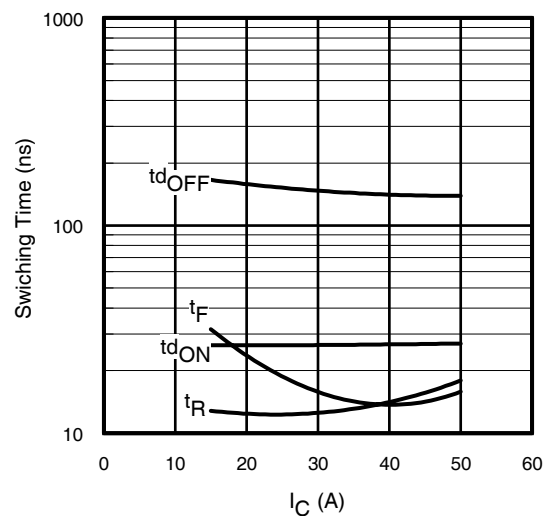

Fig. 12 - Typ. Switching Time vs. I_C
 $T_J = 125^\circ C$; $L = 200\mu H$; $V_{CE} = 390V$; $R_G = 3.3\Omega$; $V_{GE} = 15V$.
Diode clamp used: 30ETH06 (See C.T.3)

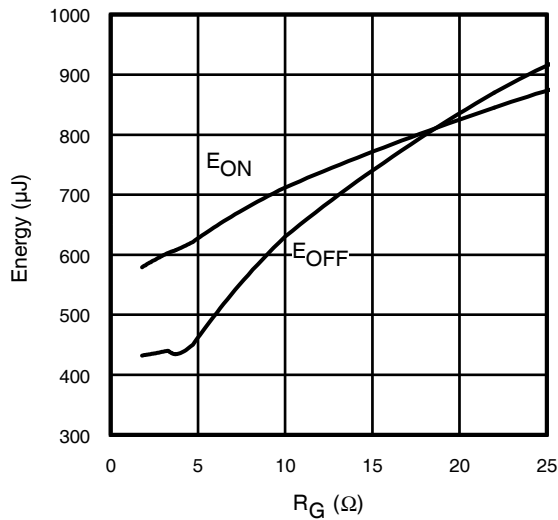

Fig. 13 - Typ. Energy Loss vs. R_G
 $T_J = 125^\circ\text{C}$; $L = 200\mu\text{H}$; $V_{CE} = 390\text{V}$; $I_{CE} = 33\text{A}$; $V_{GE} = 15\text{V}$
 Diode clamp used: 30ETH06 (See C.T.3)

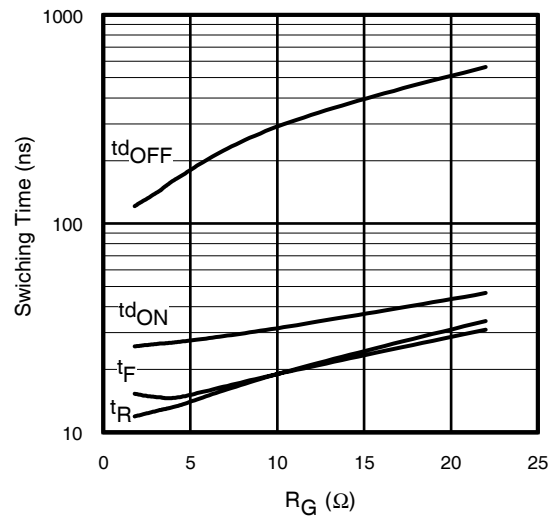
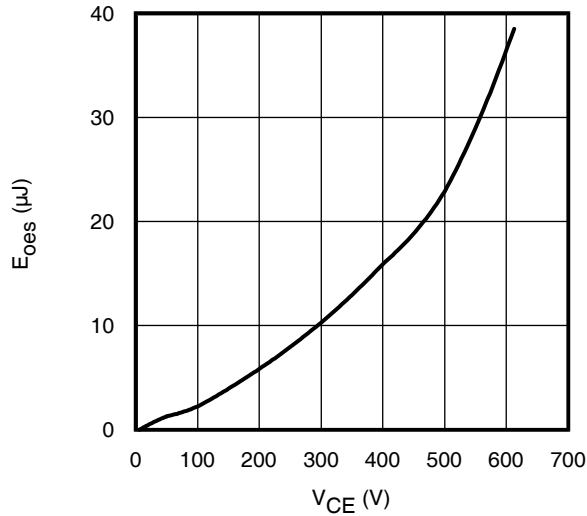

Fig. 14 - Typ. Switching Time vs. R_G
 $T_J = 125^\circ\text{C}$; $L = 200\mu\text{H}$; $V_{CE} = 390\text{V}$; $I_{CE} = 33\text{A}$; $V_{GE} = 15\text{V}$
 Diode clamp used: 30ETH06 (See C.T.3)



**Fig. 15- Typ. Output Capacitance
 Stored Energy vs. V_{CE}**

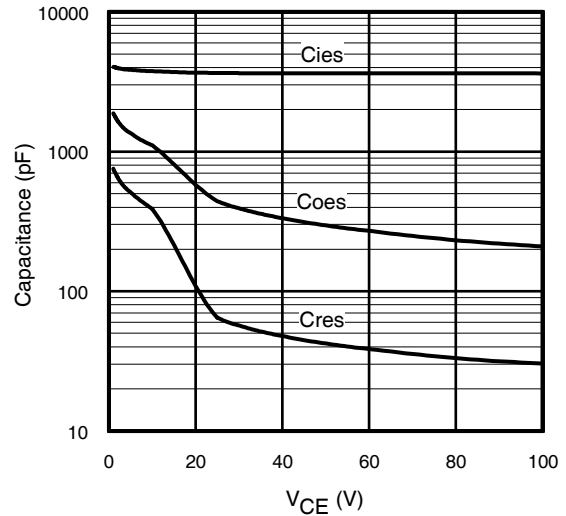

Fig. 16- Typ. Capacitance vs. V_{CE}
 $V_{GE} = 0\text{V}$; $f = 1\text{MHz}$

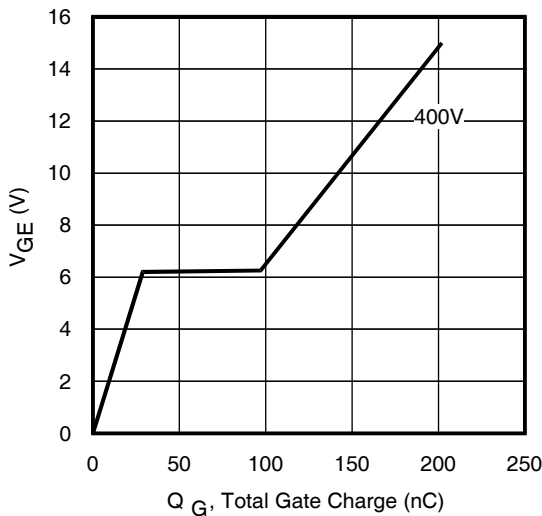
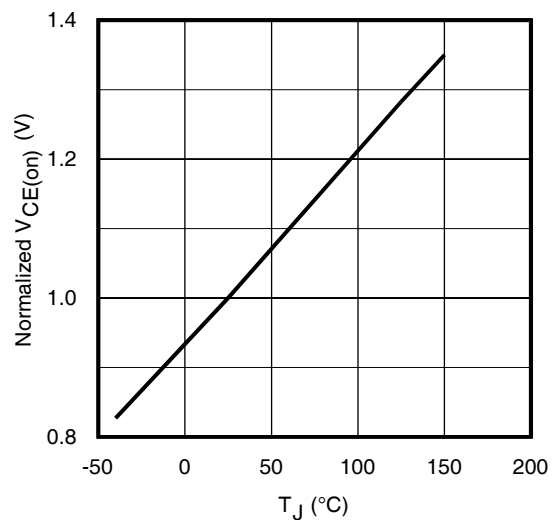

Fig. 17 - Typical Gate Charge vs. V_{GE}
 $I_{CE} = 33\text{A}$



**Fig. 18 - Normalized Typ. $V_{CE(on)}$
 vs. Junction Temperature**
 $I_C = 33\text{A}$, $V_{GE} = 15\text{V}$

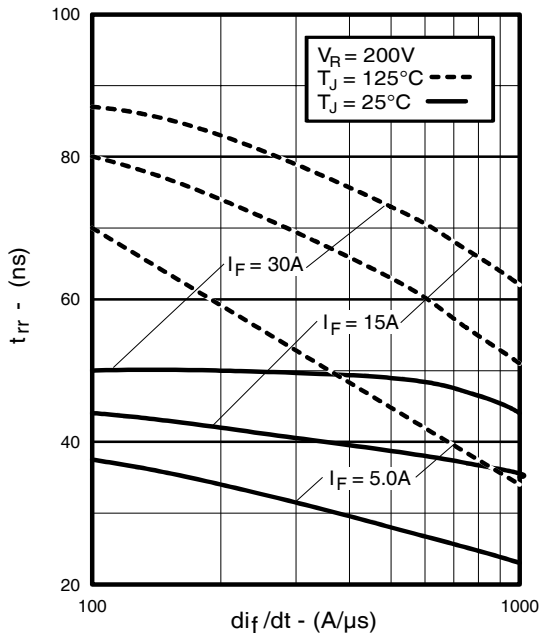

Fig. 19 - Typical Reverse Recovery vs. di_f/dt

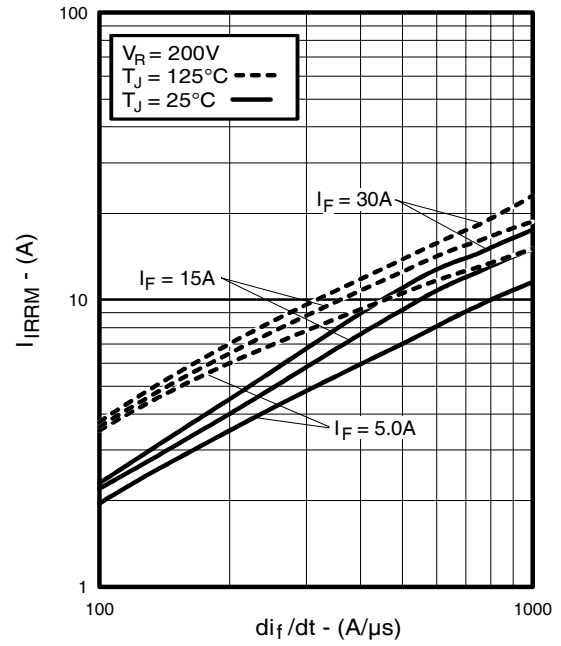

Fig. 20 - Typical Recovery Current vs. di_f/dt

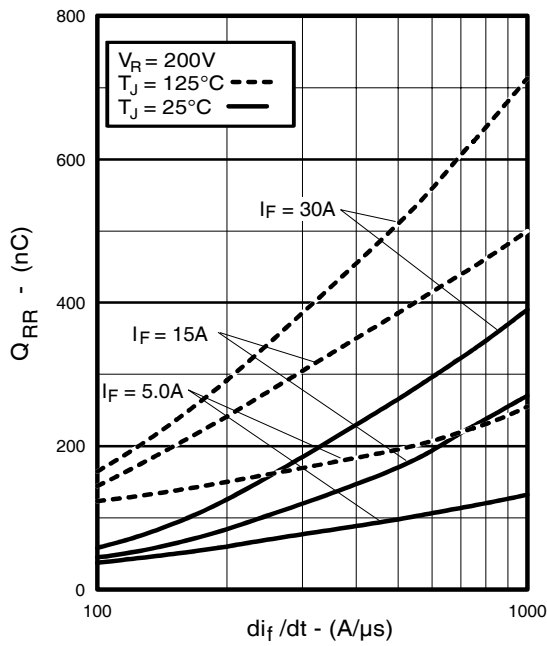

Fig. 21 - Typical Stored Charge vs. di_f/dt

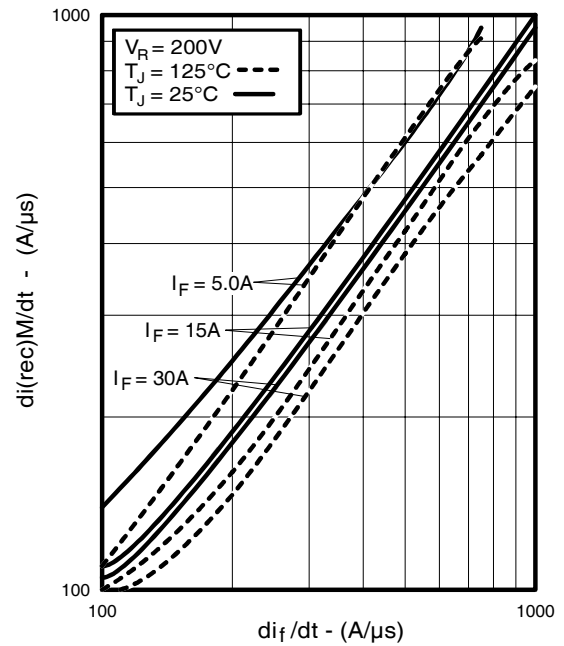

Fig. 22 - Typical $di_{(rec)M}/dt$ vs. di_f/dt

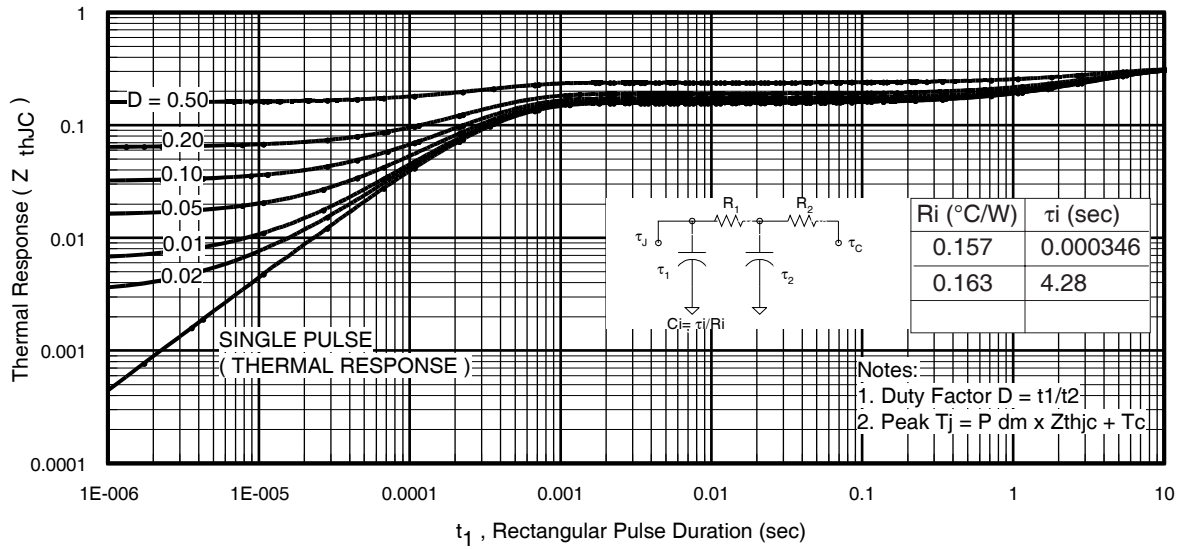

Fig 23. Maximum Transient Thermal Impedance, Junction-to-Case (IGBT)

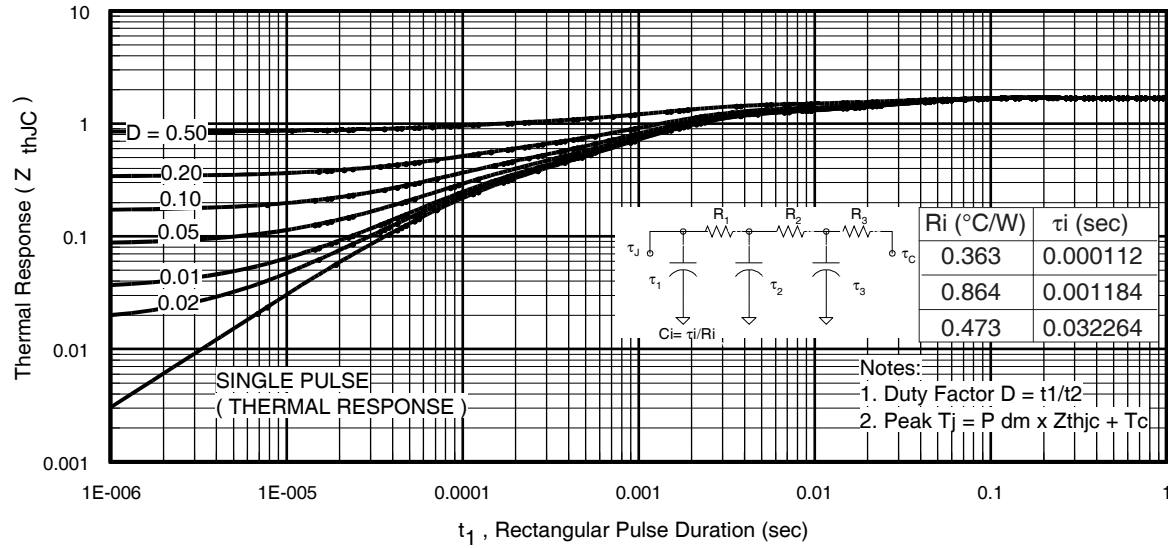

Fig 24. Maximum Transient Thermal Impedance, Junction-to-Case (DIODE)

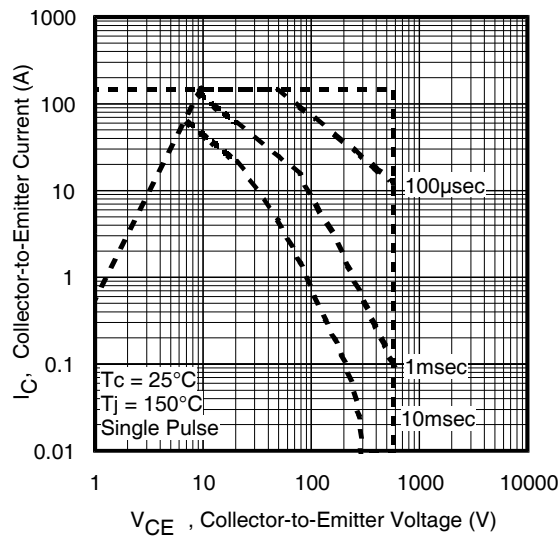

Fig. 25 - Forward SOA, $T_c = 25^\circ\text{C}$; $T_j \leq 150^\circ\text{C}$

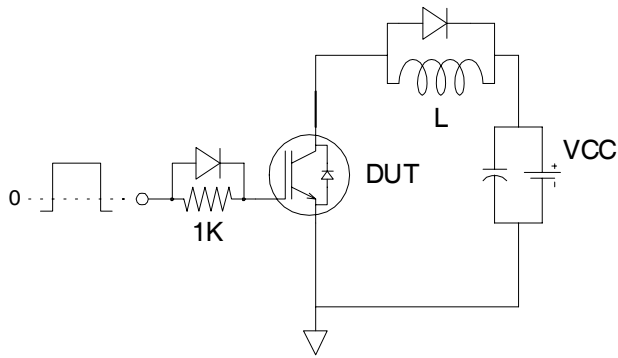

Fig.C.T.1 - Gate Charge Circuit (turn-off)

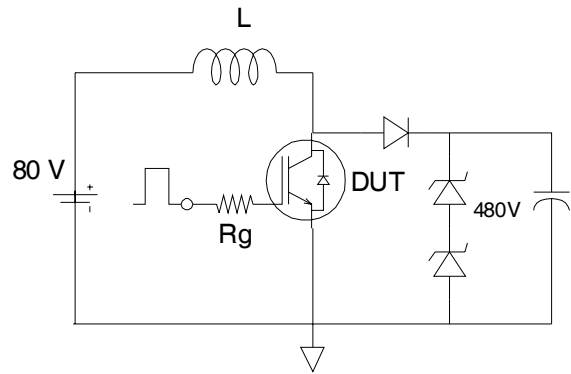

Fig.C.T.2 - RBSOA Circuit

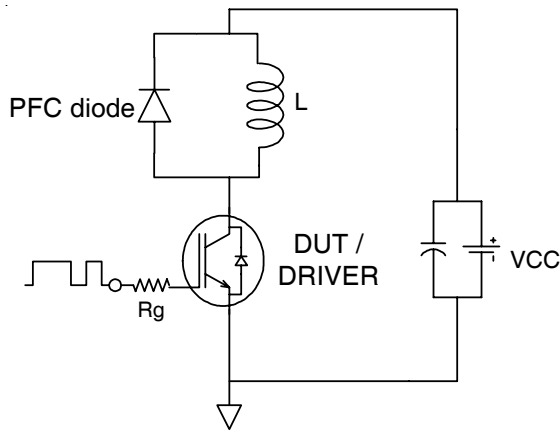

Fig.C.T.3 - Switching Loss Circuit

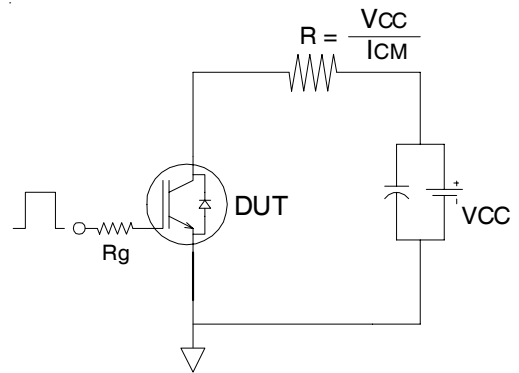

Fig.C.T.4 - Resistive Load Circuit

REVERSE RECOVERY CIRCUIT

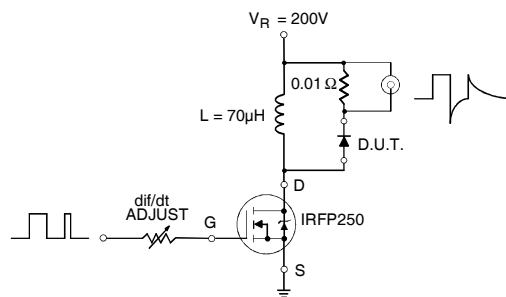

Fig. C.T.5 - Reverse Recovery Parameter Test Circuit

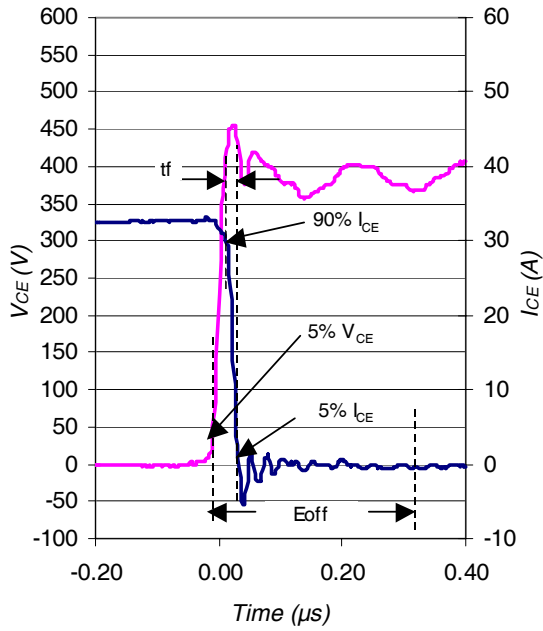

Fig. WF1 - Typ. Turn-off Loss Waveform
@ $T_J = 25^\circ\text{C}$ using Fig. CT.3

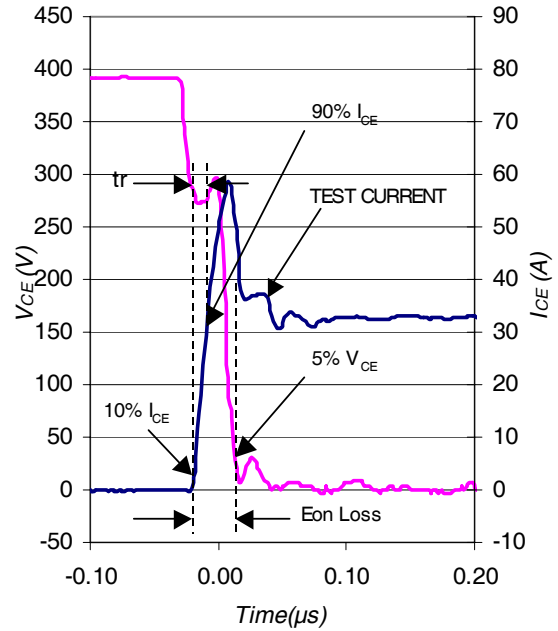
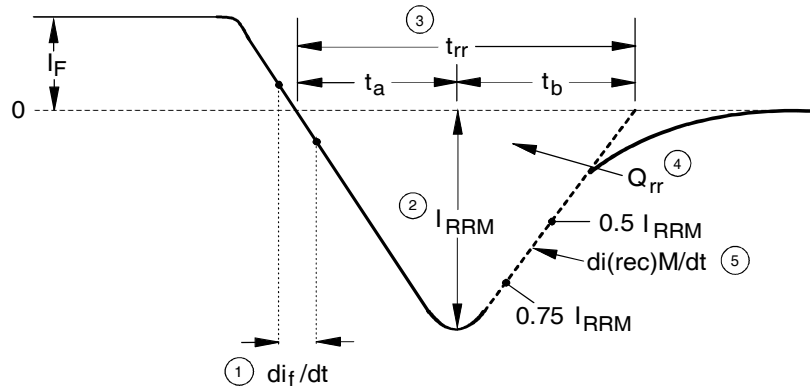

Fig. WF2 - Typ. Turn-on Loss Waveform
@ $T_J = 25^\circ\text{C}$ using Fig. CT.3



1. di_f/dt - Rate of change of current through zero crossing
2. I_{RRM} - Peak reverse recovery current
3. t_{rr} - Reverse recovery time measured from zero crossing point of negative going I_F to point where a line passing through $0.75 I_{RRM}$ and $0.50 I_{RRM}$ extrapolated to zero current
4. Q_{rr} - Area under curve defined by t_{rr} and I_{RRM}

$$Q_{rr} = \frac{t_{rr} \times I_{RRM}}{2}$$
5. $di_{(rec)M}/dt$ - Peak rate of change of current during t_b portion of t_{rr}

Fig. WF3 - Reverse Recovery Waveform and Definitions

IRGP50B60PD1

TO-247AC Package Outline

Dimensions are shown in millimeters (inches)

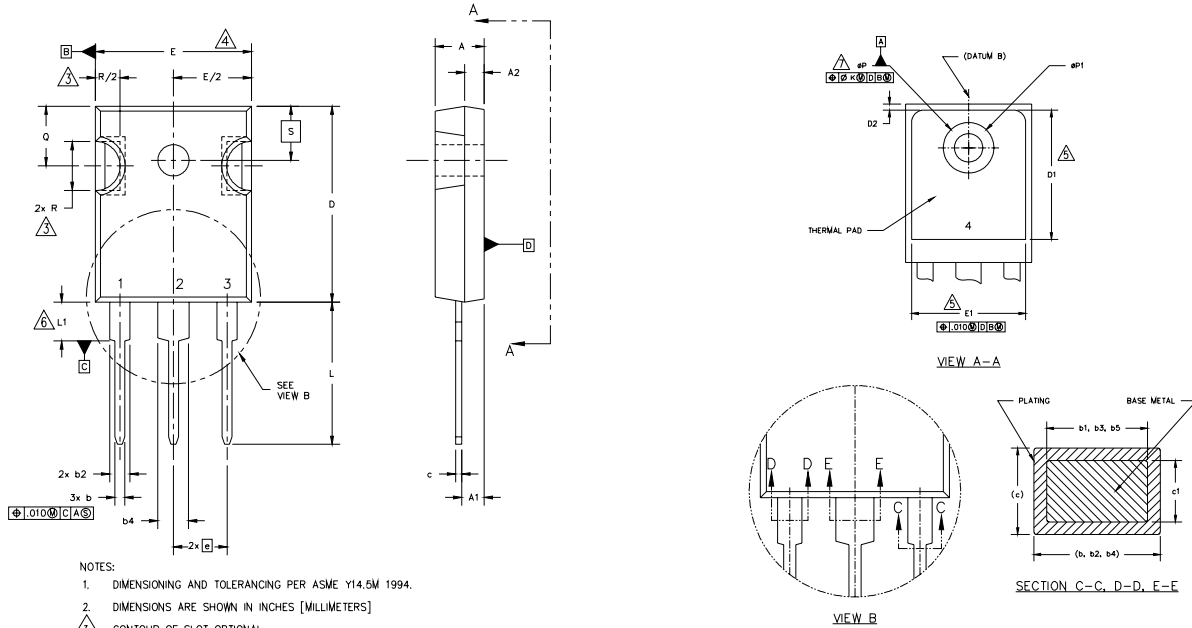

- NOTES:
1. DIMENSIONING AND TOLERANCING PER ASME Y14.5M 1994.
 2. DIMENSIONS ARE SHOWN IN INCHES [MILLIMETERS]
 3. CONTOUR OF SLOT OPTIONAL.
 4. DIMENSION D & E DO NOT INCLUDE MOLD FLASH. MOLD FLASH SHALL NOT EXCEED .005" (0.127) PER SIDE. THESE DIMENSIONS ARE MEASURED AT THE OUTERMOST EXTREMES OF THE PLASTIC BODY.
 5. THERMAL PAD CONTOUR OPTIONAL WITHIN DIMENSIONS D1 & E1.
 6. LEAD FINISH UNCONTROLLED IN L1.
 7. ϕP TO HAVE A MAXIMUM DRAFT ANGLE OF 1.5° TO THE TOP OF THE PART WITH A MAXIMUM HOLE DIAMETER OF .154" [3.91]
 8. OUTLINE CONFORMS TO JEDEC OUTLINE TO-247 WITH THE EXCEPTION OF DIMENSION c.

| SYMBOL | DIMENSIONS | | | | NOTES |
|--------|------------|------|-------------|-------|-------|
| | INCHES | | MILLIMETERS | | |
| | MIN. | MAX. | MIN. | MAX. | |
| A | .183 | .209 | 4.65 | 5.31 | |
| A1 | .087 | .102 | 2.21 | 2.59 | |
| A2 | .059 | .098 | 1.50 | 2.49 | |
| b | .039 | .055 | 0.99 | 1.40 | |
| b1 | .039 | .053 | 0.99 | 1.35 | |
| b2 | .065 | .094 | 1.65 | 2.39 | |
| b3 | .065 | .092 | 1.65 | 2.37 | |
| b4 | .102 | .135 | 2.59 | 3.43 | |
| b5 | .102 | .133 | 2.59 | 3.38 | |
| c | .015 | .034 | 0.38 | 0.86 | |
| c1 | .015 | .030 | 0.38 | 0.76 | 4 |
| D | .776 | .815 | 19.71 | 20.70 | 5 |
| D1 | .515 | - | 13.08 | - | |
| D2 | .020 | .030 | 0.51 | 0.76 | |
| E | .602 | .625 | 15.29 | 15.87 | 4 |
| E1 | .540 | - | 15.72 | - | |
| e | .215 BSC | | 5.46 BSC | | |
| g | .010 | | 2.54 | | |
| L | .559 | .634 | 14.20 | 16.10 | |
| L1 | .146 | .169 | 3.71 | 4.29 | |
| N | 3 | | 7.62 BSC | | |
| φP1 | .140 | .144 | 3.56 | 3.66 | |
| Q | - | .275 | - | 6.98 | |
| R | .209 | .224 | 5.31 | 5.69 | |
| S | .178 | .216 | 4.52 | 5.49 | |
| S | .217 BSC | | 5.51 BSC | | |

LEAD ASSIGNMENTS

HEXFET

- 1.- GATE
- 2.- DRAIN
- 3.- SOURCE
- 4.- DRAIN

IGBTs, CoPACK

- 1.- GATE
- 2.- COLLECTOR
- 3.- EMITTER
- 4.- COLLECTOR

DIODES

- 1.- ANODE/OPEN
- 2.- CATHODE
- 3.- ANODE

TO-247AC package is not recommended for Surface Mount Application.

TO-247AC Part Marking Information

EXAMPLE: THIS IS AN IRFPE30 WITH ASSEMBLY LOT CODE 5657 ASSEMBLED ON WW 35, 2000 IN THE ASSEMBLY LINE "H"
Note: "P" in assembly line position indicates "Lead-Free"

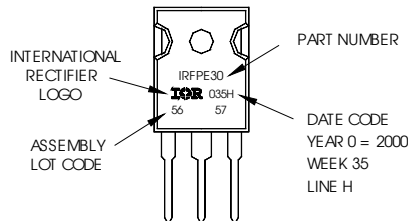

Data and specifications subject to change without notice. This product has been designed and qualified for Industrial market. Qualification Standards can be found on IR's Web site.