

## 1 Form A Solid State Relay

### Features

- Current Limit Protection
- Isolation Test Voltage 3000 V<sub>RMS</sub>
- Typical R<sub>ON</sub> 28 Ω
- Load Voltage 350 V
- Load Current 120 mA
- High Surge Capability
- Linear, AC/DC Operation
- Clean Bounce Free Switching
- Low Power Consumption
- High Reliability Monolithic Receptor
- SMD lead available on tape and reel
- Equivalent to CPC1035N

### Agency Approvals

- UL - File No. E52744 System Code O
- BSI/BABT Cert. No. 8500 issue 2

### Applications

General Telecom Switching

- On/off Hook Control
- Ring Delay
- Dial Pulse
- Ground Start
- Ground Fault Protection

Instrumentation

Industrial Controls

See "Solid State Relays" (Application Note 56)

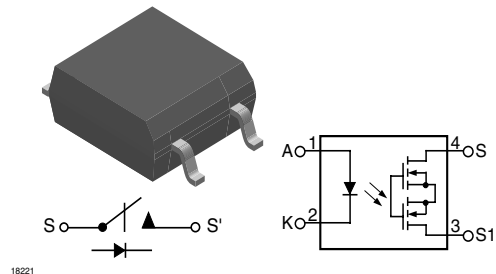

18221

### Description

The LH1546AEF (4 Pin SOP) is robust, ideal for tele-com and ground fault applications. It is a SPST normally open switch (1 Form A) that replaces electromechanical relays in many applications. It is constructed using a GaAs LED for actuation control and an integrated monolithic die for the switch output. The die, fabricated in a high-voltage dielectrically isolated BCDMOS technology, is comprised of a photodiode array, switch control circuitry and MOSFET switches. In addition, it employs current-limiting circuitry which meets FCC 68.302 and other regulatory voltage surge requirements when overvoltage protection is provided.

### Order Information

Part	Remarks
LH1546AEF	Tubes, SOP-4
LH1546AEFTR	Tape and Reel, SOP-4

### Absolute Maximum Ratings, T<sub>amb</sub> = 25 °C

Stresses in excess of the absolute Maximum Ratings can cause permanent damage to the device. Functional operation of the device is not implied at these or any other conditions in excess of those given in the operational sections of this document. Exposure to absolute Maximum Ratings for extended periods of time can adversely affect reliability.

### SSR

Parameter	Test condition	Symbol	Value	Unit
SSR output power dissipation (continuous)		P <sub>diss</sub>	550	mW
LED continuous forward current		I <sub>F</sub>	50	mA
LED reverse voltage	I <sub>R</sub> ≤ 10 μA	V <sub>R</sub>	6.0	V
DC or peak AC load voltage	I <sub>L</sub> ≤ 50 μA	V <sub>L</sub>	350	V

Parameter	Test condition	Symbol	Value	Unit
Continuous DC load current at 25 °C, Bidirectional			120	mA
Ambient temperature range		$T_{amb}$	- 40 to + 85	°C
Storage temperature range		$T_{stg}$	- 40 to + 150	°C
Soldering temperature	$t = 10$ s max	$T_{sld}$	260	°C
Isolation test voltage	for 1.0 s	$V_{ISO}$	3000	$V_{RMS}$
Isolation resistance	$V_{IO} = 500$ V, $T_{amb} = 25$ °C	$R_{IO}$	$\geq 10^{12}$	$\Omega$
	$V_{IO} = 500$ V, $T_{amb} = 100$ °C	$R_{IO}$	$\geq 10^{11}$	$\Omega$

## Electrical Characteristics, $T_{amb} = 25$ °C

Minimum and maximum values are testing requirements. Typical values are characteristics of the device and are the result of engineering evaluations. Typical values are for information only and are not part of the testing requirements.

### Input

Parameter	Test condition	Symbol	Min	Typ.	Max	Unit
LED forward current, switch turn-on	$I_L = 100$ mA, $t = 10$ ms	$I_{Fon}$		1.1	2.0	mA
LED forward current, switch turn-off	$V_L = \pm 300$ V	$I_{Foff}$	0.2	0.6		mA
LED forward voltage	$I_F = 10$ mA	$V_F$	1.0	1.18	1.45	V
Current limit	$I_F = 5.0$ mA, $t = 5.0$ ms, $V_L = \pm 6.0$ V	$I_{limit}$	230	170	250	mA

### Output

Parameter	Test condition	Symbol	Min	Typ.	Max	Unit
ON-resistance, ac/dc: Pin 3 ( $\pm$ ) to 4 ( $\pm$ )	$I_F = 5.0$ mA, $I_L = 50$ mA	$R_{ON}$		28	35	$\Omega$
OFF-resistance	$I_F = 0$ mA, $V_L = \pm 100$ V	$R_{OFF}$	0.5	5000		G $\Omega$
Off-state leakage current	$I_F = 0$ mA, $V_L = \pm 100$ V	$I_O$		0.32	200	nA
	$I_F = 0$ mA, $V_L = \pm 350$ V	$I_O$			1.0	nA
Output capacitance Pin 3 to 4	$I_F = 0$ mA, $V_L = 1.0$ V	$C_O$		55		pF
	$I_F = 0$ mA, $V_L = 50$ V	$C_O$		10		pF

### Transfer

Parameter	Test condition	Symbol	Min	Typ.	Max	Unit
Capacitance (input-output)	$V_{ISO} = 1.0$ V	$C_{IO}$		0.6		pF
Turn-on time	$I_F = 5.0$ mA, $I_L = 50$ mA	$t_{on}$		2.0	3.0	ms
Turn-off time	$I_F = 5.0$ mA, $I_L = 50$ mA	$t_{off}$		0.08	3.0	ms

## Typical Characteristics ( $T_{amb} = 25\text{ }^{\circ}\text{C}$ unless otherwise specified)

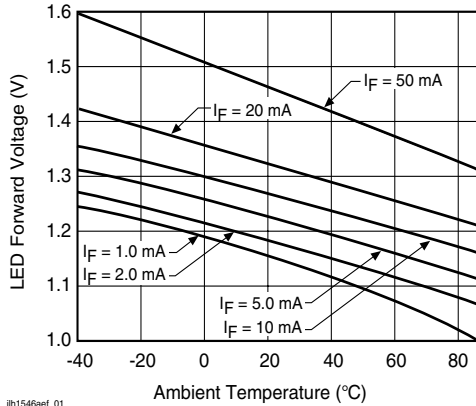

Fig. 1 LED Voltage vs. Temperature

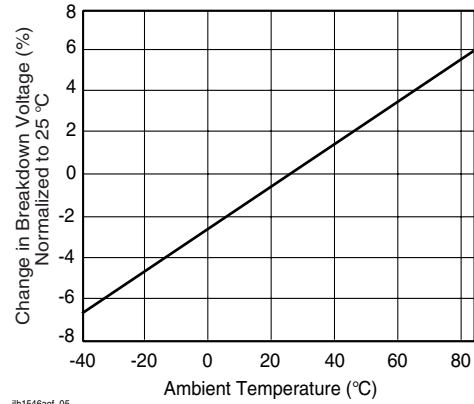

Fig. 4 Switch Breakdown Voltage vs. Temperature

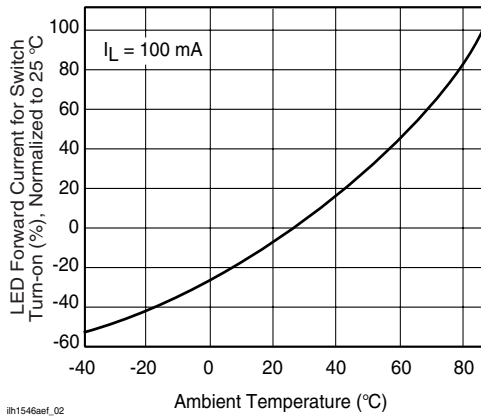

Fig. 2 LED Current for Switch Turn-on vs. Temperature

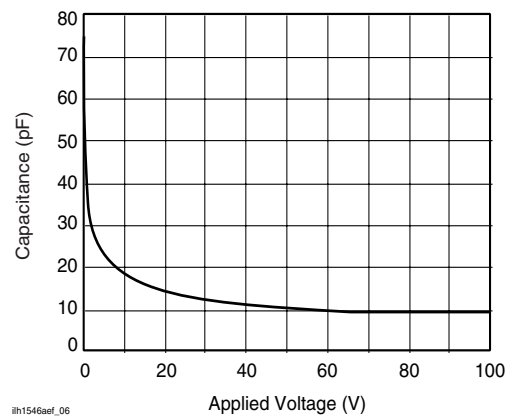

Fig. 5 Switch Capacitance vs. Applied Voltage

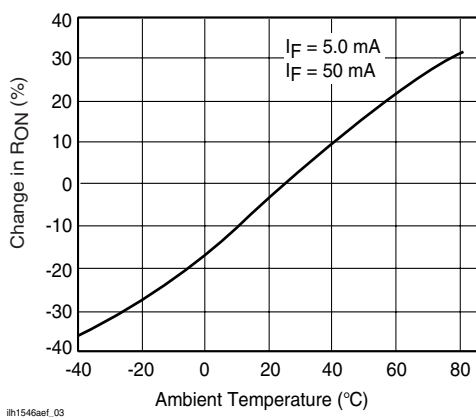

Fig. 3 ON-Resistance vs. Temperature

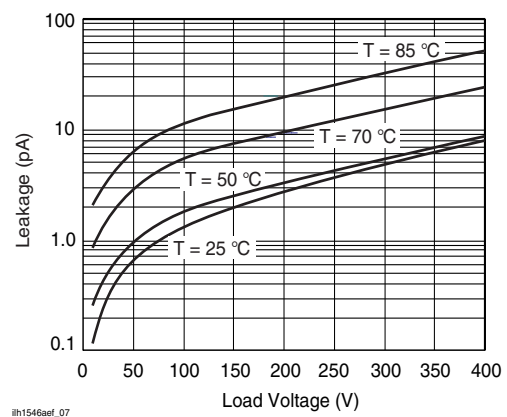

Fig. 6 Leakage Current vs. Applied Voltage

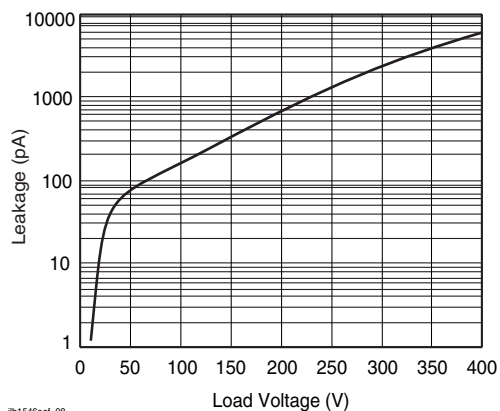

Fig. 7 Leakage Current vs. Applied Voltage

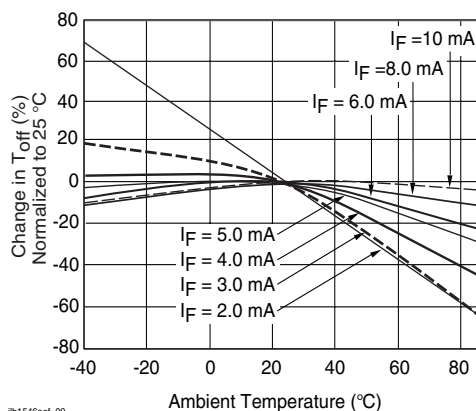

Fig. 8 Turn-off Time vs. Temperature

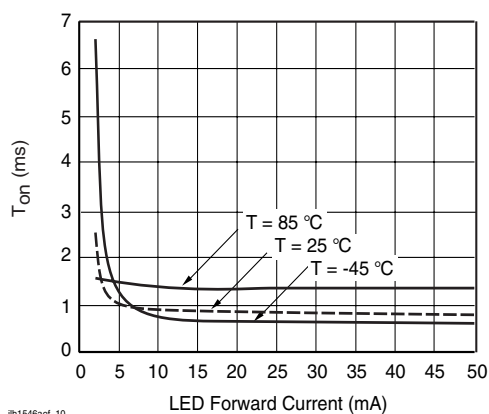
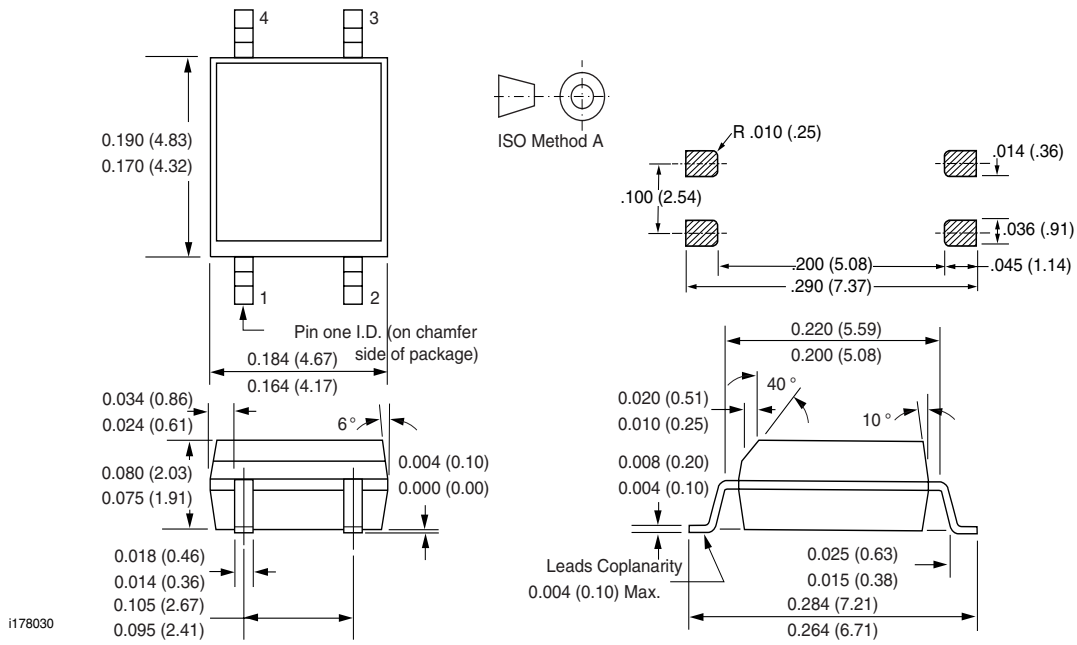

Fig. 9 Turn-on Time vs. LED Current

## Package Dimensions in Inches (mm)



### Ozone Depleting Substances Policy Statement

It is the policy of **Vishay Semiconductor GmbH** to

1. Meet all present and future national and international statutory requirements.
2. Regularly and continuously improve the performance of our products, processes, distribution and operating systems with respect to their impact on the health and safety of our employees and the public, as well as their impact on the environment.

It is particular concern to control or eliminate releases of those substances into the atmosphere which are known as ozone depleting substances (ODSs).

The Montreal Protocol (1987) and its London Amendments (1990) intend to severely restrict the use of ODSs and forbid their use within the next ten years. Various national and international initiatives are pressing for an earlier ban on these substances.

**Vishay Semiconductor GmbH** has been able to use its policy of continuous improvements to eliminate the use of ODSs listed in the following documents.

1. Annex A, B and list of transitional substances of the Montreal Protocol and the London Amendments respectively
2. Class I and II ozone depleting substances in the Clean Air Act Amendments of 1990 by the Environmental Protection Agency (EPA) in the USA
3. Council Decision 88/540/EEC and 91/690/EEC Annex A, B and C (transitional substances) respectively.

**Vishay Semiconductor GmbH** can certify that our semiconductors are not manufactured with ozone depleting substances and do not contain such substances.

**We reserve the right to make changes to improve technical design  
and may do so without further notice.**

Parameters can vary in different applications. All operating parameters must be validated for each customer application by the customer. Should the buyer use Vishay Semiconductors products for any unintended or unauthorized application, the buyer shall indemnify Vishay Semiconductors against all claims, costs, damages, and expenses, arising out of, directly or indirectly, any claim of personal damage, injury or death associated with such unintended or unauthorized use.

Vishay Semiconductor GmbH, P.O.B. 3535, D-74025 Heilbronn, Germany  
Telephone: 49 (0)7131 67 2831, Fax number: 49 (0)7131 67 2423