

The RF Line

NPN Silicon

RF Low Power Transistor

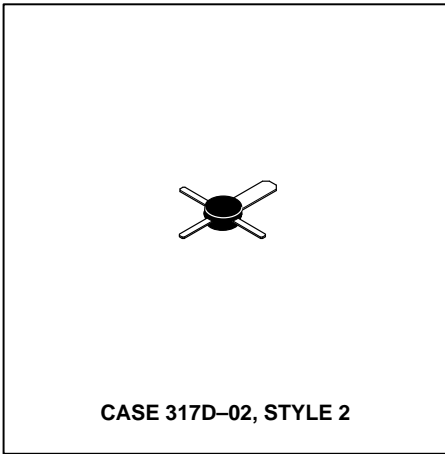
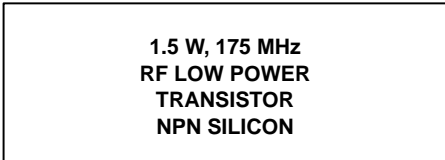

Designed primarily for wideband large signal predriver stages in the VHF frequency range.

- Specified @ 12.5 V, 175 MHz Characteristics
 - Output Power = 1.5 W
 - Minimum Gain = 11.5 dB
 - Efficiency 60% (Typ)
- Cost Effective PowerMacro Package
- Electroless Tin Plated Leads for Improved Solderability
- Circuit board photomaster available upon request by contacting RF Tactical Marketing in Phoenix, AZ.

MAXIMUM RATINGS

Rating	Symbol	Value	Unit
Collector-Emitter Voltage	V_{CEO}	16	Vdc
Collector-Base Voltage	V_{CBO}	36	Vdc
Emitter-Base Voltage	V_{EBO}	4.0	Vdc
Collector Current — Continuous	I_C	500	mAdc
Total Device Dissipation @ $T_C = 75^\circ\text{C}$ (1, 2) Derate above 75°C	P_D	3.0 40	Watts mW/ $^\circ\text{C}$
Storage Temperature Range	T_{stg}	-55 to +150	$^\circ\text{C}$

THERMAL CHARACTERISTICS

Characteristic	Symbol	Max	Unit
Thermal Resistance Junction to Case	$R_{\theta JC}$	25	$^\circ\text{C}/\text{W}$

ELECTRICAL CHARACTERISTICS ($T_A = 25^\circ\text{C}$ unless otherwise noted)

Characteristic	Symbol	Min	Typ	Max	Unit
----------------	--------	-----	-----	-----	------

OFF CHARACTERISTICS

Collector-Emitter Breakdown Voltage ($I_C = 10$ mAdc, $I_B = 0$)	$V_{(BR)CEO}$	16	—	—	Vdc
Collector-Emitter Breakdown Voltage ($I_C = 5.0$ mAdc, $V_{BE} = 0$)	$V_{(BR)CES}$	36	—	—	Vdc
Collector-Base Breakdown Voltage ($I_C = 5.0$ mAdc, $I_E = 0$)	$V_{(BR)CBO}$	36	—	—	Vdc
Emitter-Base Breakdown Voltage ($I_E = 1.0$ mAdc, $I_C = 0$)	$V_{(BR)EBO}$	4.0	—	—	Vdc
Collector Cutoff Current ($V_{CE} = 15$ Vdc, $V_{BE} = 0$, $T_C = 25^\circ\text{C}$)	I_{CES}	—	—	5.0	mAdc

ON CHARACTERISTICS

DC Current Gain ($I_C = 250$ mAdc, $V_{CE} = 5.0$ Vdc)	h_{FE}	30	—	200	—
--	----------	----	---	-----	---

NOTES:

- T_C , Case temperature measured on collector lead immediately adjacent to body of package.
- The MRF553 PowerMacro must be properly mounted for reliable operation. AN938, "Mounting Techniques in PowerMacro Transistor," discusses methods of mounting and heatsinking.

(continued)

ELECTRICAL CHARACTERISTICS — continued ($T_A = 25^\circ\text{C}$ unless otherwise noted)

Characteristic	Symbol	Min	Typ	Max	Unit
DYNAMIC CHARACTERISTICS					
Output Capacitance ($V_{CB} = 10\text{ Vdc}$, $I_E = 0$, $f = 1.0\text{ MHz}$)	C_{ob}	—	12	20	pF
FUNCTIONAL TESTS					
Common-Emitter Amplifier Power Gain ($V_{CC} = 12.5\text{ Vdc}$, $P_{out} = 1.5\text{ W}$, $f = 175\text{ MHz}$)	Figures 1, 2 G_{pe}	11.5	13	—	dB
Collector Efficiency ($V_{CC} = 12.5\text{ Vdc}$, $P_{out} = 1.5\text{ W}$, $f = 175\text{ MHz}$)	Figures 1, 2 η	50	60	—	%
Load Mismatch Stress ($V_{CC} = 12.5\text{ Vdc}$, $P_{out} = 1.5\text{ W}$, $f = 175\text{ MHz}$, $VSWR \geq 10:1$ All Phase Angles)	ψ	No Degradation in Output Power			—

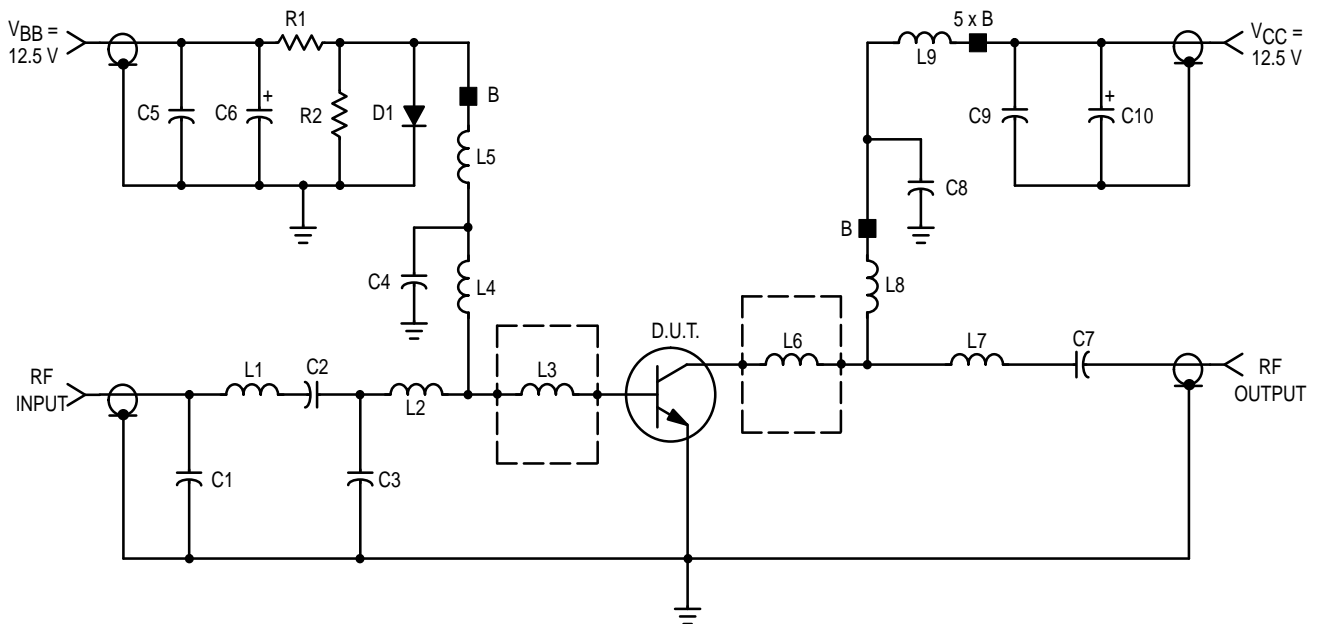

- C1 — 36 pF Mini Underwood
- C2 — 47 pF Mini Underwood
- C3 — 91 pF Mini Underwood
- C4 — 68 pF Mini Underwood
- C5, C9 — 1.0 μF Erie Red Cap Capacitor
- C6, C10 — 0.1 μF , 35 V Tantalum
- C7 — 470 pF Chip Capacitor
- C8 — 2200 pF Chip Capacitor
- R1 — 4.7 k Ω , 1/4 W
- R2 — 100 Ω , 1/4 W
- D1 — 1N4148 Diode

- L1 — 3 Turns, #18 AWG, 0.210" ID, 3/16" Length
- L2, L4, L7 — 0.62", #18 AWG Wire Bent into "V"
- L3, L6 — 60 x 125 x 250 Mils Copper Pad on 27 Mils Thick Alumina Substrate
- L5 — 12 μH Molded Choke
- L8 — 7 Turns, #18 AWG, 0.170" ID, 7/16" Length
- L9 — 1.0", #18 AWG Wire with 5 Ferrite Beads
- B — Ferrite Bead
- Board Material — Glass Teflon, $\epsilon_r = 2.56$, $t = 0.0625"$

Figure 1. 140–175 MHz Broadband Circuit Schematic

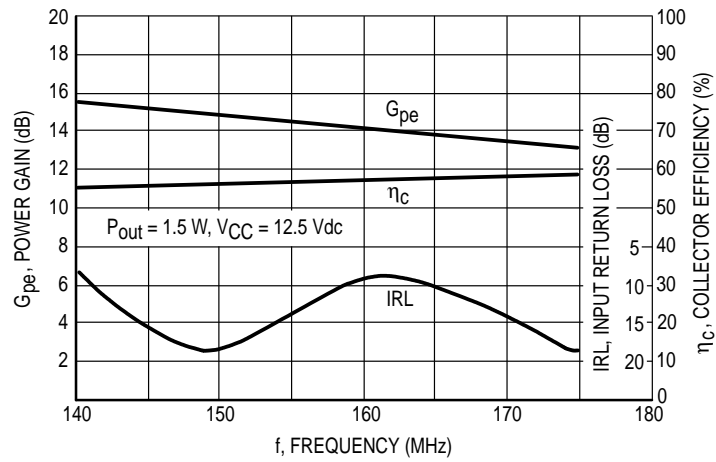

Figure 2. Typical Performance in Broadband Circuit

f Frequency MHz	Z_{in} Ohms						Z_{OL}^* Ohms					
	$V_{CC} = 7.5 \text{ V}; P_{in}$			$V_{CC} = 12.5 \text{ V}; P_{in}$			$V_{CC} = 7.5 \text{ V}; P_{out}$			$V_{CC} = 12.5 \text{ V}; P_{out}$		
	100 mW	200 mW	300 mW	50 mW	100 mW	150 mW	1.0 W	1.6 W	2.2 W	1.1 W	2.0 W	2.6 W
140	1.65-j3.6	2.0-j2.6	2.3-j1.2	1.7-j4.1	1.8-j3.1	1.9-j2.7	9.9-j11.1	10.6-j5.1	10-j4.9	28.3-j21.5	16-j20.5	16.3-j16.5
175	2.5-j5.6	2.3-j5.9	2.8-j4.0	2.3-j4.6	2.4-j1.2	2.4-j5.7	12.1-j14.9	7.2-j9.8	8.1-j5.4	30.8-j23.3	11.4-j20.9	11.1-j14.3

f Frequency MHz	Z_{in} Ohms						Z_{OL}^* Ohms					
	$V_{CC} = 7.5 \text{ V}; P_{in}$			$V_{CC} = 12.5 \text{ V}; P_{in}$			$V_{CC} = 7.5 \text{ V}; P_{out}$			$V_{CC} = 12.5 \text{ V}; P_{out}$		
	50 mW	100 mW	200 mW	25 mW	50 mW	100 mW	1.25 W	1.5 W	2.0 W	1.5 W	2.25 W	3.0 W
90	2.5-j9.3	2.5-j6.4	2.5-j4.4	1.6-j10.7	2.5-j7.1	2.2-j1.3	31.8-j9.2	32-j8.9	30.2-j10.7	45.8-j7.2	45.2-j3.9	40-j4.5

Z_{OL}^* = Conjugate of the optimum load impedance into which the device output operates at a given output power, voltage and frequency.

Table 1. Z_{in} and Z_{OL} versus Collector Voltage, Input Power, and Output Power

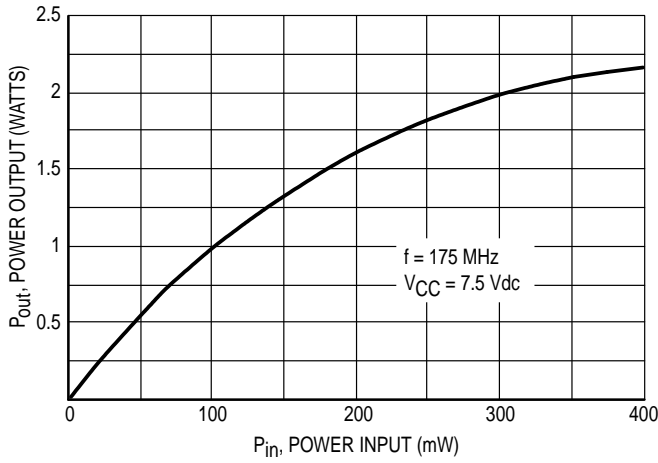

Figure 3. Power Output versus Power Input

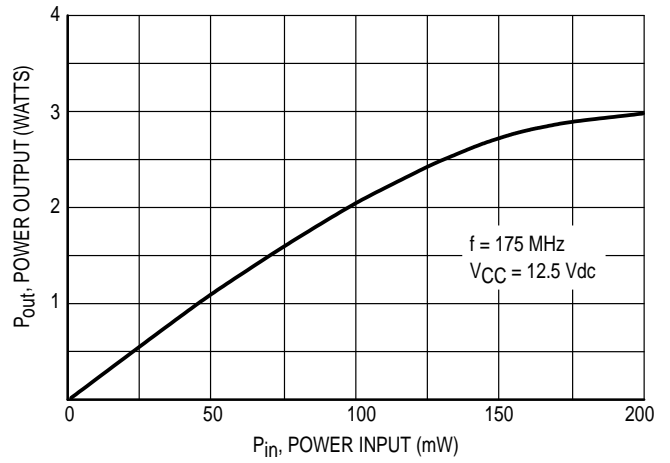

Figure 4. Power Output versus Power Input

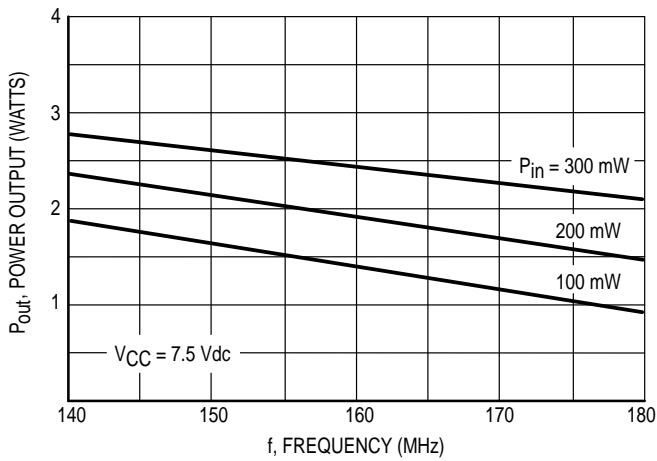

Figure 5. Power Output versus Frequency

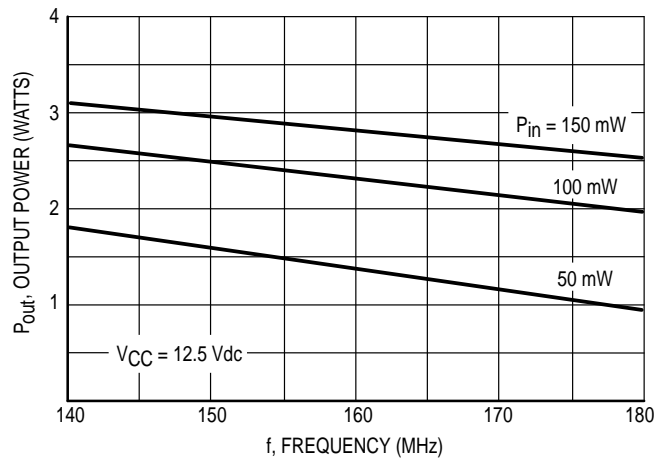

Figure 6. Power Output versus Frequency

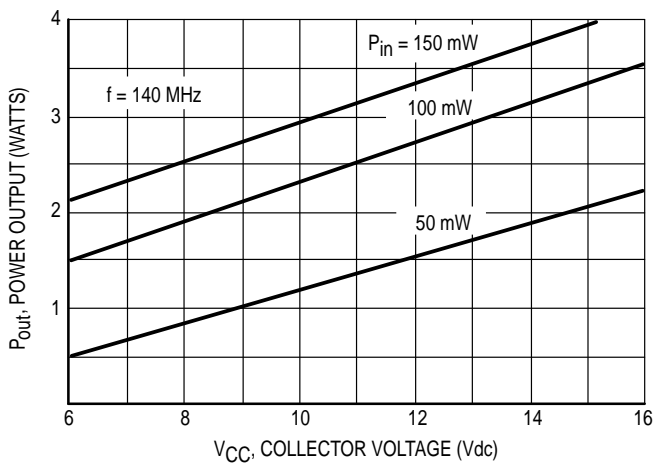

Figure 7. Power Output versus Collector Voltage

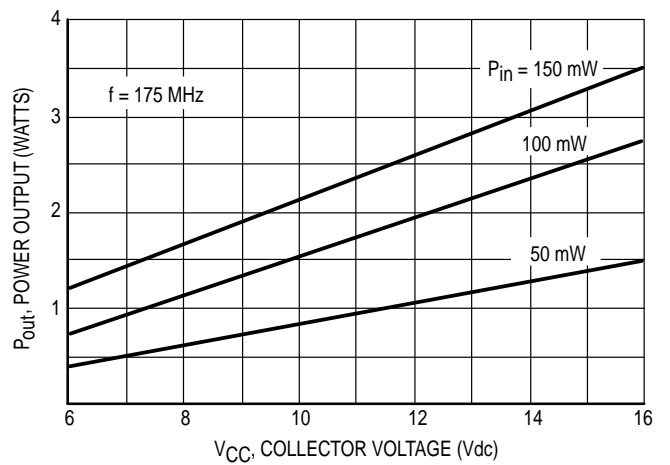
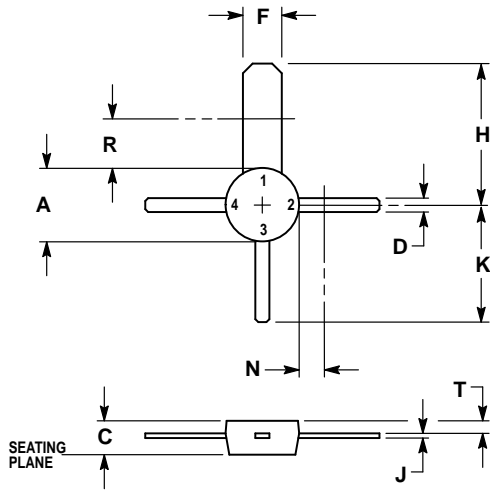

Figure 8. Power Output versus Collector Voltage

PACKAGE DIMENSIONS



- NOTES:
 1. DIMENSIONING AND TOLERANCING PER ANSI Y14.5M, 1982.
 2. CONTROLLING DIMENSION: INCH.
 3. LEAD DIMENSIONS UNCONTROLLED WITHIN DIMENSION N AND R.

DIM	INCHES		MILLIMETERS	
	MIN	MAX	MIN	MAX
A	0.175	0.205	4.45	5.20
C	0.075	0.100	1.91	2.54
D	0.033	0.039	0.84	0.99
F	0.097	0.104	2.46	2.64
H	0.348	0.383	8.84	9.72
J	0.008	0.012	0.24	0.30
K	0.285	0.320	7.24	8.12
N	—	0.065	—	1.65
R	—	0.128	—	3.25
T	0.025	0.040	0.64	1.01

- STYLE 2:
 PIN 1. COLLECTOR
 2. EMITTER
 3. BASE
 4. EMITTER

**CASE 317D-02
 ISSUE C**

Motorola reserves the right to make changes without further notice to any products herein. Motorola makes no warranty, representation or guarantee regarding the suitability of its products for any particular purpose, nor does Motorola assume any liability arising out of the application or use of any product or circuit, and specifically disclaims any and all liability, including without limitation consequential or incidental damages. "Typical" parameters can and do vary in different applications. All operating parameters, including "Typicals" must be validated for each customer application by customer's technical experts. Motorola does not convey any license under its patent rights nor the rights of others. Motorola products are not designed, intended, or authorized for use as components in systems intended for surgical implant into the body, or other applications intended to support or sustain life, or for any other application in which the failure of the Motorola product could create a situation where personal injury or death may occur. Should Buyer purchase or use Motorola products for any such unintended or unauthorized application, Buyer shall indemnify and hold Motorola and its officers, employees, subsidiaries, affiliates, and distributors harmless against all claims, costs, damages, and expenses, and reasonable attorney fees arising out of, directly or indirectly, any claim of personal injury or death associated with such unintended or unauthorized use, even if such claim alleges that Motorola was negligent regarding the design or manufacture of the part. Motorola and  are registered trademarks of Motorola, Inc. Motorola, Inc. is an Equal Opportunity/Affirmative Action Employer.

How to reach us:

USA / EUROPE: Motorola Literature Distribution;
P.O. Box 20912; Phoenix, Arizona 85036. 1-800-441-2447

JAPAN: Nippon Motorola Ltd.; Tatsumi-SPD-JLDC, Toshikatsu Otsuki,
6F Seibu-Butsuryu-Center, 3-14-2 Tatsumi Koto-Ku, Tokyo 135, Japan. 03-3521-8315

MFAX: RMFAX0@email.sps.mot.com – TOUCHTONE (602) 244-6609
INTERNET: <http://Design-NET.com>

HONG KONG: Motorola Semiconductors H.K. Ltd.; 8B Tai Ping Industrial Park,
51 Ting Kok Road, Tai Po, N.T., Hong Kong. 852-26629298



MRF553/D



This datasheet has been download from:

www.datasheetcatalog.com

Datasheets for electronics components.