

Analog Devices Welcomes Hittite Microwave Corporation

NO CONTENT ON THE ATTACHED DOCUMENT HAS CHANGED



THIS PAGE INTENTIONALLY LEFT BLANK



HMC245QS16 / 245QS16E

GaAs MMIC SP3T NON-REFLECTIVE SWITCH, DC - 3.5 GHz

Typical Applications

The HMC245QS16 / HMC245QS16E is ideal for:

- Basestation Infrastructure
- CATV / DBS
- Wireless Local Loop
- Test Equipment

Features

- Low Insertion Loss: 0.5 dB @ 2.0 GHz
- Non-Reflective Design
- Integrated 2:3 TTL Decoder
- “All Off” Isolation State
- Single Positive Supply: Vdd = +5V
- 16 Lead QSOP SMT Package

Functional Diagram

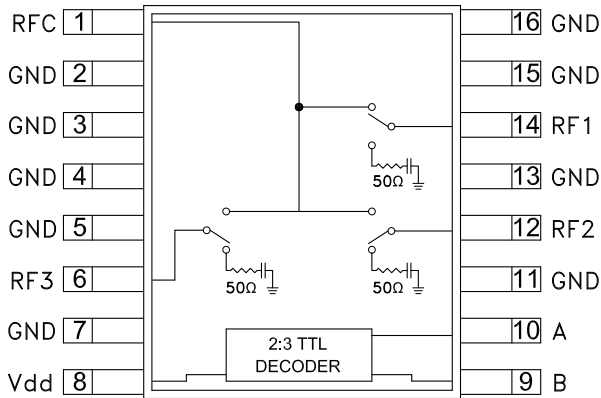

General Description

The HMC245QS16 & HMC245QS16E are low cost non-reflective SP3T switches in 16-lead QSOP surface mount packages. Covering DC to 3.5 GHz, the switch offers 30 to 40 dB isolation and a low insertion loss of 0.5 dB. A 2:3 TTL/CMOS compatible decoder is integrated on the switch requiring only 2 control lines and a single +5V bias to select each path, replacing 6 control lines normally required by GaAs SP3T switches.

Electrical Specifications,

$T_A = +25^\circ C$, For TTL Control and Vdd= +5V in a 50 Ohm System

Parameter	Frequency	Min.	Typ.	Max.	Units
Insertion Loss	DC - 2.0 GHz		0.5	0.8	dB
	DC - 3.0 GHz		0.6	0.9	dB
	DC - 3.5 GHz		0.7	1.0	dB
Isolation	DC - 1.0 GHz	40	44		dB
	DC - 2.0 GHz	35	39		dB
	DC - 2.5 GHz	31	35		dB
	DC - 3.5 GHz	26	30		dB
Return Loss	“On State”	DC - 1.5 GHz	20		dB
		DC - 3.5 GHz	17		dB
Return Loss RF1 - 3	“Off State”	0.3 - 3.5 GHz	12		dB
		0.5 - 3.5 GHz	15		dB
Input Power for 1 dB Compression	0.3 - 2.5 GHz	23	26		dBm
	0.3 - 3.5 GHz	22	25		dBm
Input Third Order Intercept (Two-tone Input Power = +7 dBm each tone)	0.3 - 2.5 GHz	44	48		dBm
	0.3 - 3.5 GHz	40	44		dBm
Switching Characteristics	0.3 - 3.5 GHz	tRISE, tFALL (10/90% RF)	40		ns
		tON, tOFF (50% CTL to 10/90% RF)	150		ns

For price, delivery, and to place orders, please contact Hittite Microwave Corporation:
 20 Alpha Road, Chelmsford, MA 01824 Phone: 978-250-3343 Fax: 978-250-3373
 Order On-line at www.hittite.com



HMC245QS16 / 245QS16E

GaAs MMIC SP3T NON-REFLECTIVE SWITCH, DC - 3.5 GHz

Insertion Loss vs. Temperature

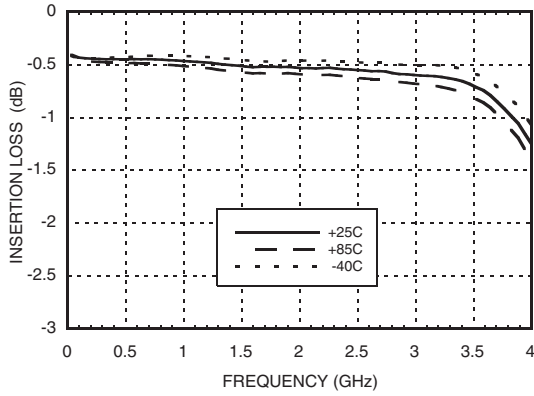

Isolation

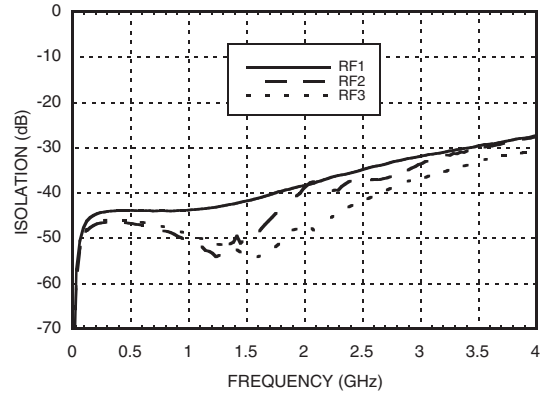

Return Loss

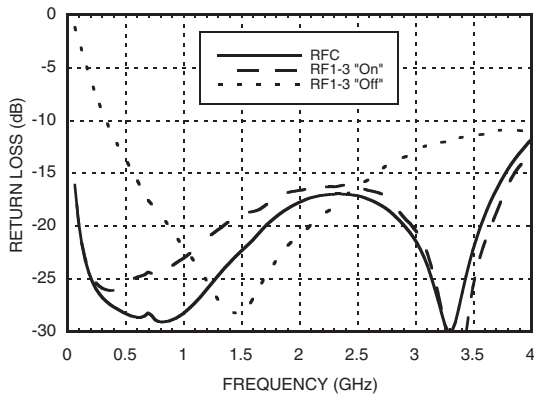

Off State Isolation

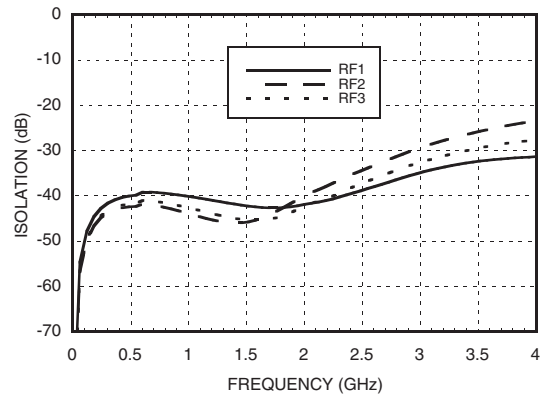

0.1 and 1 dB Input Compression Point

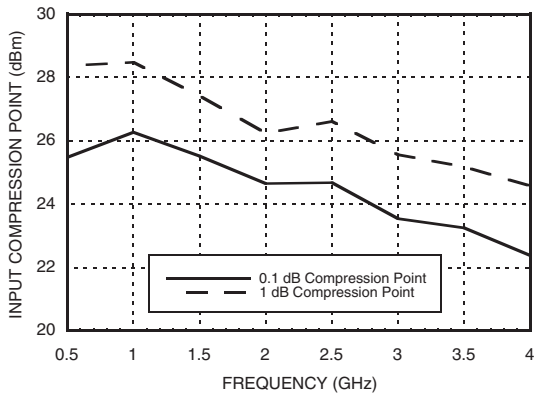

Input Third Order Intercept Point

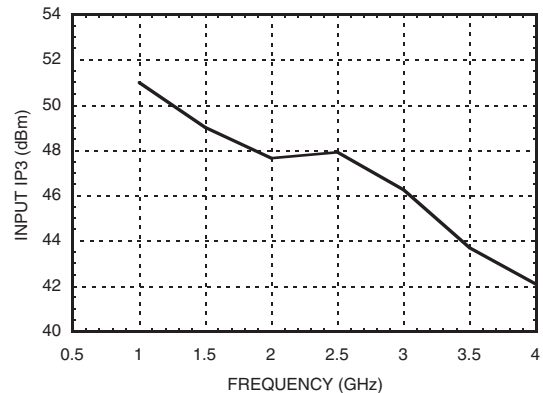



MICROWAVE CORPORATION v02.0805



HMC245QS16 / 245QS16E

GaAs MMIC SP3T NON-REFLECTIVE SWITCH, DC - 3.5 GHz

Bias Voltage & Current

Vdd Range= +5.0 Vdc ±10%		
Vdd (Vdc)	Idd (Typ) (mA)	Idd (Max) (mA)
+5.0	3.0	6.0

TTL/CMOS Control Voltages

State	Bias Condition
Low	0 to +0.8 Vdc @ 5 uA Typ.
High	+2.0 to +5.0 Vdc @ 70 uA Typ.

Truth Table

Control Input		Signal Path State
A	B	RF COM to:
Low	Low	RF1
High	Low	RF2
Low	High	RF3
High	High	All Off

Absolute Maximum Ratings

Bias Voltage Range (Port Vdd)	+7.0 Vdc
Control Voltage Range (A & B)	-0.5V to Vdd +1 Vdc
Channel Temperature	150 °C
Thermal Resistance (Insertion Loss Path)	210 °C/W
Thermal Resistance (Terminated Path)	250 °C/W
Storage Temperature	-65 to +150 °C
Operating Temperature	-40 to +85 °C
Maximum Input Power Vdd = +5 Vdc	+20 dBm (0.05 - 0.5 GHz) +27 dBm (0.5 - 3.5 GHz)
ESD Sensitivity (HBM)	Class 1A



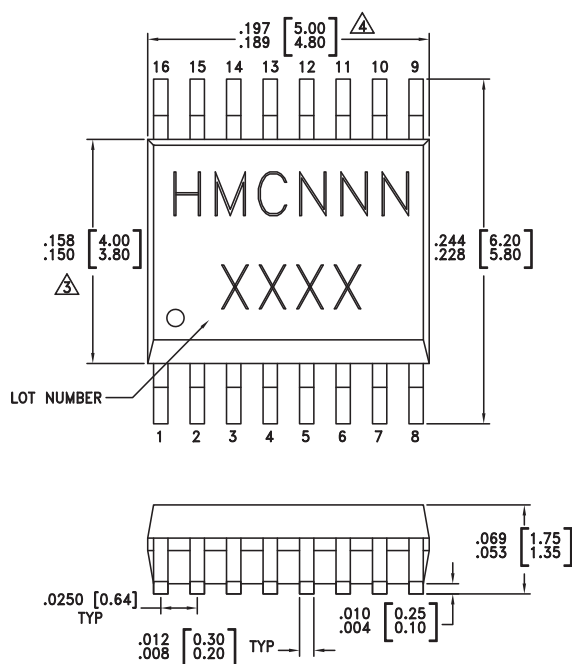

ELECTROSTATIC SENSITIVE DEVICE
OBSERVE HANDLING PRECAUTIONS

Outline Drawing



NOTES:

- LEADFRAME MATERIAL: COPPER ALLOY
- DIMENSIONS ARE IN INCHES [MILLIMETERS].
-  DIMENSION DOES NOT INCLUDE MOLDFLASH OF 0.15mm PER SIDE.
-  DIMENSION DOES NOT INCLUDE MOLDFLASH OF 0.25mm PER SIDE.
- ALL GROUND LEADS MUST BE SOLDERED TO PCB RF GROUND.

Package Information

Part Number	Package Body Material	Leadframe Plating	MSL Rating	Package Marking ^[3]
HMC245QS16	Low Stress Injection Molding Plastic Silica and Silicon Impregnated	Sn/Pb Solder	MSL1 ^[1]	HMC245 XXXX
HMC245QS16E	RoHS-compliant Low Stress Injection Molding Plastic Silica and Silicon Impregnated	100% Matte Tin	MSL1 ^[2]	HMC245 XXXX

[1] Max peak reflow temperature of 235 °C

[2] Max peak reflow temperature of 260 °C

[3] 4-Digit lot number XXXX

For price, delivery, and to place orders, please contact Hittite Microwave Corporation:
20 Alpha Road, Chelmsford, MA 01824 Phone: 978-250-3343 Fax: 978-250-3373
Order On-line at www.hittite.com

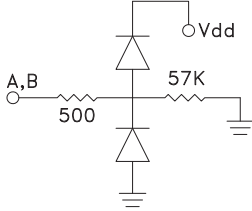

Pin Descriptions

Pin Number	Function	Description	Interface Schematic
1, 6, 12, 14	RF3, RF2, RF1, RFC	This pin is DC coupled and matched to 50 Ohms. Blocking capacitors are required.	
2 - 5, 7, 11, 13, 15, 16	GND	This pin must be connected to PCB RF ground to maximize isolation.	
8	Vdd	Supply Voltage +5.0 Vdc ±10%	
9	B	See truth table and control voltage table.	
10	A	See truth table and control voltage table.	

Evaluation PCB

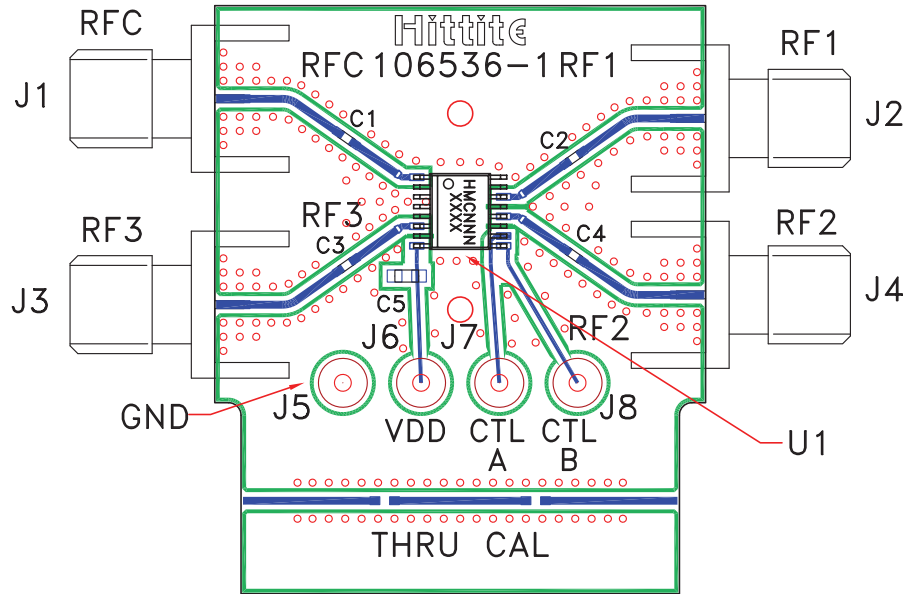

List of Materials for Evaluation PCB 106687 [1]

Item	Description
J1 - J4	PCB Mount SMA RF Connector
J5 - J8	DC Pin
C1 - C4	100 pF Capacitor, 0402 Pkg.
C5	10k pF Capacitor, 0603 Pkg.
U1	HMC245QS16 / HMC245QS16E SP3T Switch
PCB [2]	106536 Evaluation PCB

[1] Reference this number when ordering complete evaluation PCB

[2] Circuit Board Material: Rogers 4350

The circuit board used in the final application should be generated with proper RF circuit design techniques. Signal lines at the RF port should have 50 ohm impedance and the package ground leads should be connected directly to the ground plane similar to that shown above. The evaluation circuit board shown above is available from Hittite Microwave Corporation upon request.

Mouser Electronics

Authorized Distributor

Click to View Pricing, Inventory, Delivery & Lifecycle Information:

[Analog Devices Inc.:](#)

[HMC245QS16E](#) [HMC245QS16ETR](#) [106687-HMC245QS16](#) [HMC245QS16](#)