

CKT. SIZE	DIM. A	DIM. B
4	2.00	4.00
6	4.00	6.00
8	6.00	8.00
10	8.00	10.00
12	10.00	12.00
14	12.00	14.00
16	14.00	16.00
18	16.00	18.00
20	18.00	20.00
22	20.00	22.00
24	22.00	24.00
26	24.00	26.00
28	26.00	28.00
30	28.00	30.00
32	30.00	32.00
34	32.00	34.00
36	34.00	36.00
38	36.00	38.00
40	38.00	40.00
42	40.00	42.00
44	42.00	44.00

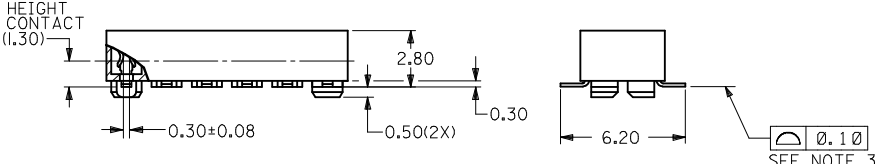

**PART NO. LEGEND**

87263 - \* \* \* \*

CIRCUIT SIZE

PLATING OPTION  
 3 - 0.38um MIN. GOLD  
 5 - 0.76um MIN. GOLD  
 6 - (0.13-0.38)um GOLD FLASH

PACKAGING  
 0 - W/CAP IN TUBE (SEE SHEET 2)  
 2 - W/O CAP IN TUBE (SEE SHEET 2)  
 8 - W/O CAP IN TAPE & REEL (SEE SHEET 3)  
 9 - W/CAP IN TAPE & REEL (SEE SHEET 3)

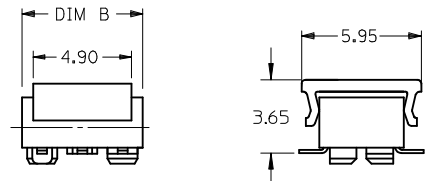
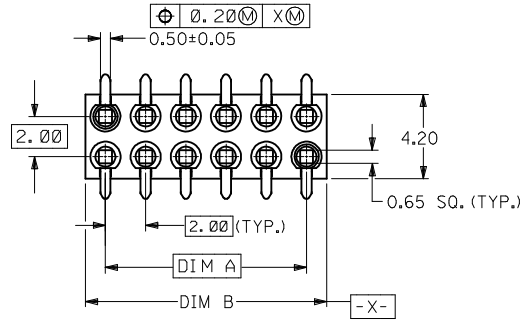

PARTS TO BE PACK WITH CAP (12 CKT SHOWN)

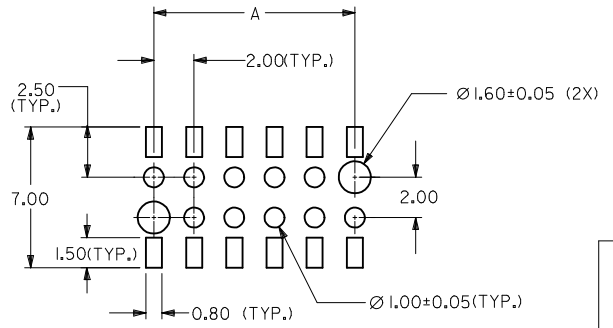

RECOMMENDED SOLDER PAD DESIGN

**NOTES:**

- FOR ILLUSTRATION PURPOSES, DRAWING SHOWS PART WITH 12 CIRCUIT SIZE.
- PLATING  
 POST-PLATING - SELECTIVE GOLD (SEE LEGEND) AT CONTACT AREA, AND 1.27um MIN. SELECTIVE TIN AT SOLDER AREA BOTH OVER 1.27um MIN. NICKEL OVERALL.
- CO-PLANARITY OF P.C TAIL TO BE MEASURED BY RESTING THE PART ON A FLAT GAGE SURFACE.
- PRODUCT SPECIFICATION PS-87263 APPLIES.
- CAP : HIGH TEMPERATURE THERMOPLASTIC, UL RATED 94V-0, SUITABLE FOR SURFACE-MOUNT SOLDERING PROCESS. COLOR BLACK
- POSITION OF CAP TO BE CENTRAL WITH RESPECT TO DIMENSION "A"
- CONTACT FACTORY FOR DETAILS ON THIS PART NO.
- PARTS SHALL BE PACKED IN MOISTURE BARRIER BAG.
- P/N: 87263-3686 TO BE PACKED IN EMBOSSED TAPE TYPE B1.

SEE SHEET 3 EC NO: S2015-0829 DRWN:CGOH CHKD:ATSEE APPR:KLL IM 2015/04/16 2015/04/17 2015/04/17	REV DESCRIPTION	QUALITY SYMBOLS	GENERAL TOLERANCES (UNLESS SPECIFIED)	DIMENSION STYLE	SCALE	DESIGN UNITS	THIRD ANGLE PROJECTION																			
		$\nabla_A = 0$ $\nabla_G = 0$ $\nabla_F = 0$	<table border="1"> <thead> <tr> <th></th> <th>mm</th> <th>INCH</th> </tr> </thead> <tbody> <tr> <td>4 PLACES</td> <td>± ---</td> <td>± ---</td> </tr> <tr> <td>3 PLACES</td> <td>± ---</td> <td>± ---</td> </tr> <tr> <td>2 PLACES</td> <td>± 0.20</td> <td>± ---</td> </tr> <tr> <td>1 PLACE</td> <td>± ---</td> <td>± ---</td> </tr> <tr> <td>0 PLACE</td> <td>±</td> <td>±</td> </tr> </tbody> </table>		mm	INCH	4 PLACES	± ---	± ---	3 PLACES	± ---	± ---	2 PLACES	± 0.20	± ---	1 PLACE	± ---	± ---	0 PLACE	±	±	MM ONLY	NTS	METRIC	DRAWN BY: JDK DATE: 1991/01/11 CHECKED BY: MLA I DATE: 1991/01/11 APPROVED BY: MLONG DATE: 2010/03/19	TITLE MGRID, B/ENTRY RECEPT. 2.80MM HT. W/LOC. PEGS W/CAP, SMT
			mm	INCH																						
4 PLACES	± ---	± ---																								
3 PLACES	± ---	± ---																								
2 PLACES	± 0.20	± ---																								
1 PLACE	± ---	± ---																								
0 PLACE	±	±																								
ANGULAR ± 3 ° DRAFT WHERE APPLICABLE MUST REMAIN WITHIN DIMENSIONS	MATERIAL NO. SEE TABLE	DOCUMENT NO. SD-87263-**2*	SHEET NO. 1 OF 4																							



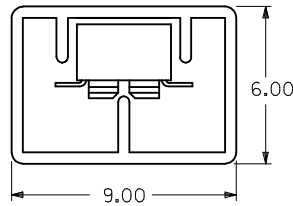
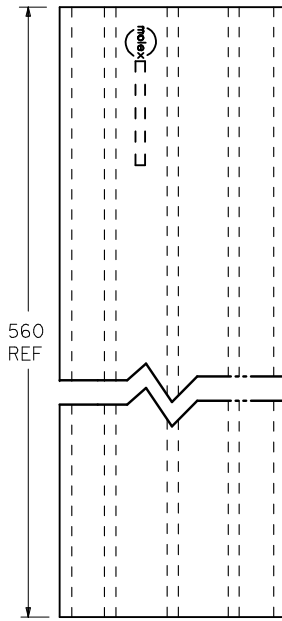

P/N 87263-\*\*\*2\*

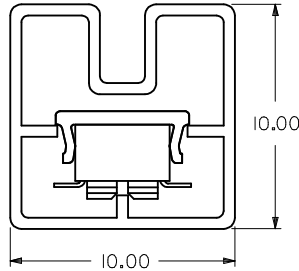
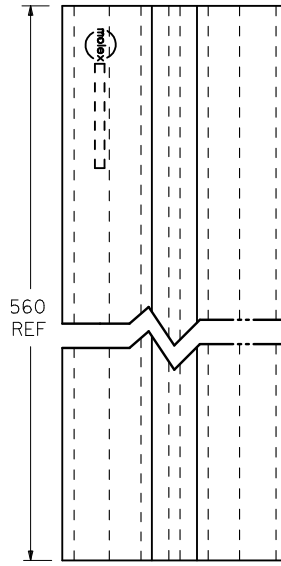

P/N 87263-\*\*\*0\*

CKT. SIZE	PART NO. FOR PARTS WITHOUT CAP	△ PART NO. FOR PARTS WITH CAP
4	87263-042*	87263-040*
6	87263-062*	87263-060*
8	87263-082*	87263-080*
10	87263-102*	87263-100*
12	87263-122*	87263-120*
14	87263-142*	87263-140*
16	87263-162*	87263-160*
18	87263-182*	87263-180*
20	87263-202*	87263-200*
22	87263-222*	87263-220*
24	87263-242*	87263-240*
26	87263-262*	87263-260*
28	87263-282*	87263-280*
30	87263-302*	87263-300*
32	87263-322*	87263-320*
34	87263-342*	87263-340*
36	87263-362*	87263-360*
38	87263-382*	87263-380*
40	87263-402*	87263-400*
42	87263-422*	87263-420*
44	△ 87263-442*	87263-440*

<b>SEE SHEET 3</b> IEC NO: S2015-0829 DRWNG: CGOH CH'KD: ATSEE APPR: KHLIM 2015/04/16 2015/04/27 2015/04/27	QUALITY SYMBOLS $F_A=0$ $F_B=0$ $F_C=0$	GENERAL TOLERANCES (UNLESS SPECIFIED) <table border="1"> <thead> <tr> <th></th> <th>mm</th> <th>INCH</th> </tr> </thead> <tbody> <tr><td>4 PLACES</td><td>± ---</td><td>± ---</td></tr> <tr><td>3 PLACES</td><td>± ---</td><td>± ---</td></tr> <tr><td>2 PLACES</td><td>± 0.20</td><td>± ---</td></tr> <tr><td>1 PLACE</td><td>± ---</td><td>± ---</td></tr> <tr><td>0 PLACE</td><td>±</td><td>±</td></tr> </tbody> </table>		mm	INCH	4 PLACES	± ---	± ---	3 PLACES	± ---	± ---	2 PLACES	± 0.20	± ---	1 PLACE	± ---	± ---	0 PLACE	±	±	DIMENSION STYLE <b>MM ONLY</b>	SCALE <b>NTS</b>	DESIGN UNITS <b>METRIC</b>	THIRD ANGLE PROJECTION
		mm	INCH																					
	4 PLACES	± ---	± ---																					
	3 PLACES	± ---	± ---																					
2 PLACES	± 0.20	± ---																						
1 PLACE	± ---	± ---																						
0 PLACE	±	±																						
DRAWN BY JDK DATE 1991/01/11	CHECKED BY MLAI DATE 1991/01/11	APPROVED BY MLONG DATE 2010/03/19	TITLE <b>MGRID, B/ENTRY RECEPT.          2.80MM HT. W/LOC. PEGS          W/CAP, SMT</b>																					
MATERIAL NO. <b>SEE TABLE</b>			DOCUMENT NO. <b>SD-87263-***2*</b>			SHEET NO. <b>2 OF 4</b>																		
DRAFT WHERE APPLICABLE MUST REMAIN WITHIN DIMENSIONS			THIS DRAWING CONTAINS INFORMATION THAT IS PROPRIETARY TO MOLEX INCORPORATED AND SHOULD NOT BE USED WITHOUT WRITTEN PERMISSION																					

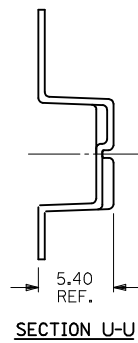
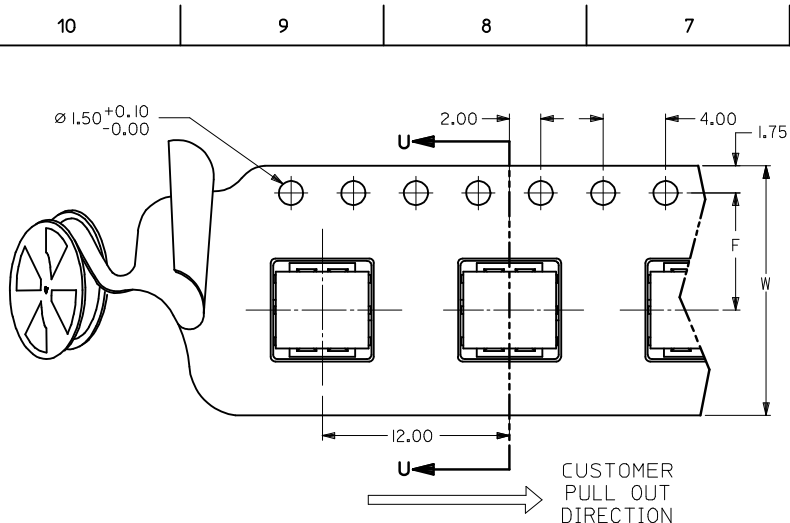

PART NO. 87263-\*\*\*9\* (CKTS 04 TO 14)  
SINGLE SPROCKET HOLE T/REEL - TYPE A

△ PART NO. FOR PARTS WITHOUT CAP IN T/REEL	△ PART NO. FOR PARTS WITH CAP IN T/REEL	CKT. SIZE	F	So	W	T/REEL TYPE
87263-048*	87263-049*	4	11.5	-	24	A
87263-068*	87263-069*	6	11.5	-	24	
87263-088*	87263-089*	8	11.5	-	24	
87263-108*	87263-109*	10	11.5	-	24	
87263-128*	87263-129*	12	11.5	-	24	
87263-148*	87263-149*	14	11.5	-	24	
87263-168*	87263-169*	16	11.5	-	24	
87263-188*	87263-189*	18	14.2	28.4	32	
87263-208*	87263-209*	20	20.2	40.4	44	
87263-228*	87263-229*	22	20.2	40.4	44	
87263-248*	87263-249*	24	20.2	40.4	44	
87263-268*	87263-269*	26	20.2	40.4	44	
87263-288*	87263-289*	28	20.2	40.4	44	
87263-308*	87263-309*	30	20.2	40.4	44	
87263-328*	87263-329*	32	26.2	52.4	56	
87263-348*	87263-349*	34	-	-	-	
△ 87263-368*	87263-369*	36	26.2	52.4	56	
87263-388*	87263-389*	38	-	-	-	
87263-408*	87263-409*	40	-	-	-	
△ 87263-3686	-	36	26.2	52.4	56	B1

NOTES:

- LEADER AND TRAILER TAPE
- PEELING OFF FORCE OF THE TOP TAPE: 20-80gf.  
 (PEELING DIRECTION AS SHOWN IN FOLLOWING FIGURE)
- PACKAGING STANDARD IS AS PER EIA-481.
- TAPE & REEL QUANTITY: EMBOSSED TYPE A & B = 1000PCS/REEL  
 EMBOSSED TYPE B1 = 900PCS/REEL
- THE TAPE IS TREATED FOR ANTI-STATIC.

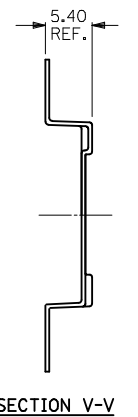
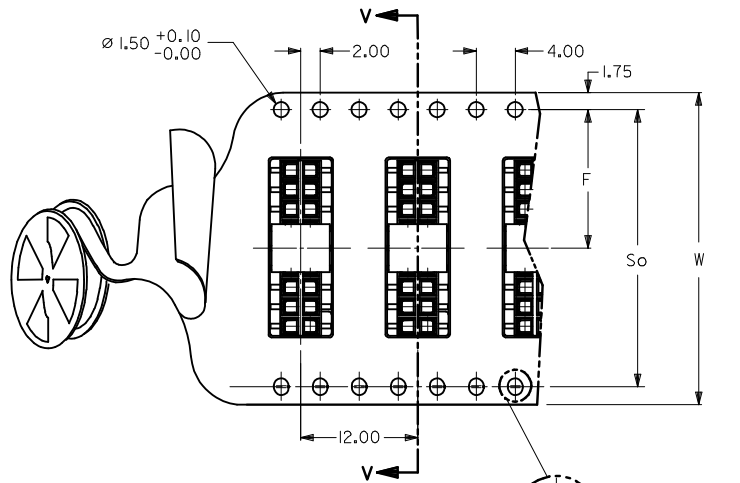

PART NO. 87263-\*\*\*9\* (CKTS 16 TO 40)  
DOUBLE SPROCKET HOLE T/REEL - TYPE B

REVISE 87263-229* EC NO: S2015-0829 DRWN:CGOH 2015/04/16 CHKD:ATSEE 2015/04/27 APPR:KHLIM 2015/04/27	QUALITY SYMBOLS	GENERAL TOLERANCES (UNLESS SPECIFIED)	DIMENSION STYLE	SCALE	DESIGN UNITS	THIRD ANGLE PROJECTION																		
	$\nabla_A=0$ $\nabla_C=0$ $\nabla_P=0$	<table border="1"> <thead> <tr> <th></th> <th>mm</th> <th>INCH</th> </tr> </thead> <tbody> <tr><td>4 PLACES</td><td>± ---</td><td>± ---</td></tr> <tr><td>3 PLACES</td><td>± ---</td><td>± ---</td></tr> <tr><td>2 PLACES</td><td>± 0.20</td><td>± ---</td></tr> <tr><td>1 PLACE</td><td>± ---</td><td>± ---</td></tr> <tr><td>0 PLACE</td><td>±</td><td>±</td></tr> </tbody> </table>		mm	INCH	4 PLACES	± ---	± ---	3 PLACES	± ---	± ---	2 PLACES	± 0.20	± ---	1 PLACE	± ---	± ---	0 PLACE	±	±	MM ONLY	NTS	METRIC	
		mm	INCH																					
	4 PLACES	± ---	± ---																					
3 PLACES	± ---	± ---																						
2 PLACES	± 0.20	± ---																						
1 PLACE	± ---	± ---																						
0 PLACE	±	±																						
DESCRIPTION	ANGULAR ± 3 °	DRAWN BY	DATE	TITLE																				
REV	DRAFT WHERE APPLICABLE MUST REMAIN WITHIN DIMENSIONS	JDK	1991/01/11	MGRID, B/ENTRY RECEPT. 2.80MM HT. W/LOC. PEGS W/CAP, SMT																				
		MLA1	1991/01/11	<b>molex</b>																				
		MLONG	2010/03/19	DOCUMENT NO. SD-87263-***2*	SHEET NO. 3 OF 4																			
		SIZE A3	THIS DRAWING CONTAINS INFORMATION THAT IS PROPRIETARY TO MOLEX INCORPORATED AND SHOULD NOT BE USED WITHOUT WRITTEN PERMISSION																					

T/REEL TYPE B1

PART WITHOUT CAP IN T&R	CKT SIZE	Bo	Ko	Ao
9 87263-3686	36	36.40	5.00	6.60

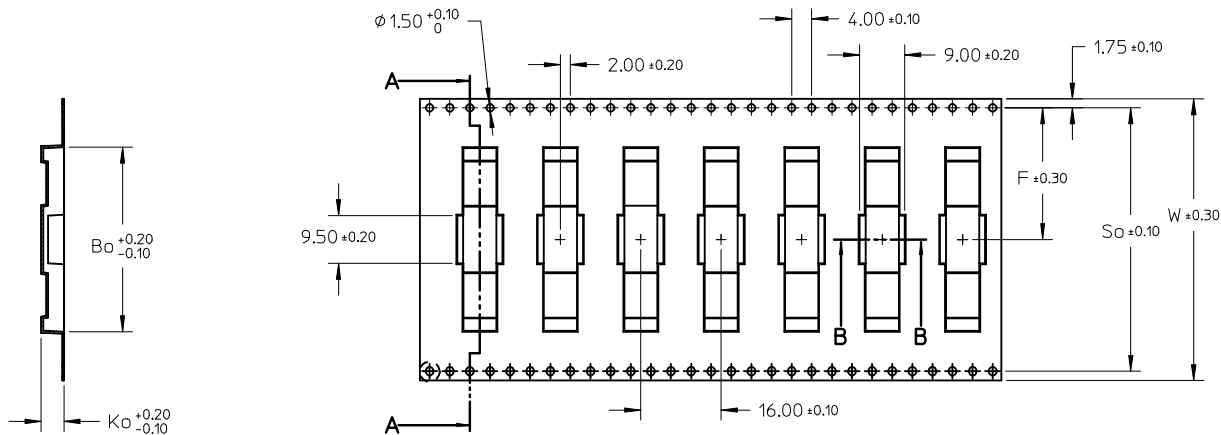

SECTION A-A

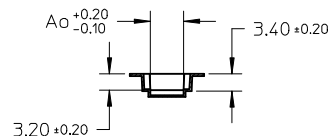

SECTION B-B

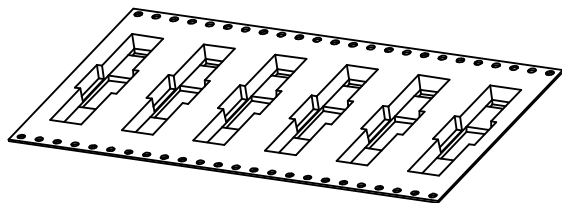

SEE SHEET 3 EC NO: S2015-0829 DRWING: G0H CHKD: AISEE APPR: KHLIM 2015/04/16 2015/04/17 2015/04/17	QUALITY SYMBOLS	GENERAL TOLERANCES (UNLESS SPECIFIED)		DIMENSION STYLE MM ONLY		SCALE NTS	DESIGN UNITS METRIC	THIRD ANGLE PROJECTION	
	$\nabla_A = 0$ $\nabla_C = 0$ $\nabla_P = 0$	4 PLACES ± --- ± --- 3 PLACES ± --- ± --- 2 PLACES ± 0.20 ± --- 1 PLACE ± --- ± --- 0 PLACE ± ±	mm	INCH	DRAWN BY JDK	DATE 1991/01/11	TITLE	MGRID, B/ENTRY RECEPT. 2.80MM HT. W/LOC. PEGS W/CAP, SMT	
	DESCRIPTION	DRAFT WHERE APPLICABLE MUST REMAIN WITHIN DIMENSIONS		CHECKED BY MLAI	DATE 1991/01/11	MATERIAL NO. SD-87263-**2*		SHEET NO. 4 OF 4	
	REV J10	ANGULAR ± 3 °		APPROVED BY MLONG		DATE 2010/03/19	molex DOCUMENT NO. SD-87263-**2*		

# Mouser Electronics

Authorized Distributor

Click to View Pricing, Inventory, Delivery & Lifecycle Information:

[Molex:](#)

[87263-0693](#)