

HEF4093B

Quad 2-input NAND Schmitt trigger

Rev. 8 — 21 November 2011

Product data sheet

1. General description

The HEF4093B is a quad two-input NAND gate. Each input has a Schmitt trigger circuit. The gate switches at different points for positive-going and negative-going signals. The difference between the positive voltage (V_{T+}) and the negative voltage (V_{T-}) is defined as hysteresis voltage (V_H).

It operates over a recommended V_{DD} power supply range of 3 V to 15 V referenced to V_{SS} (usually ground). Unused inputs must be connected to V_{DD} , V_{SS} , or another input.

2. Features and benefits

- Schmitt trigger input discrimination
- Fully static operation
- 5 V, 10 V, and 15 V parametric ratings
- Standardized symmetrical output characteristics
- Specified from $-40\text{ }^{\circ}\text{C}$ to $+85\text{ }^{\circ}\text{C}$ and $-40\text{ }^{\circ}\text{C}$ to $+125\text{ }^{\circ}\text{C}$
- Complies with JEDEC standard JESD 13-B

3. Applications

- Wave and pulse shapers
- Astable multivibrators
- Monostable multivibrators

4. Ordering information

Table 1. Ordering information

All types operate from $-40\text{ }^{\circ}\text{C}$ to $+125\text{ }^{\circ}\text{C}$

Type number	Package		
	Name	Description	Version
HEF4093BP	DIP14	plastic dual in-line package; 14 leads (300 mil)	SOT27-1
HEF4093BT	SO14	plastic small outline package; 14 leads; body width 3.9 mm	SOT108-1



5. Functional diagram

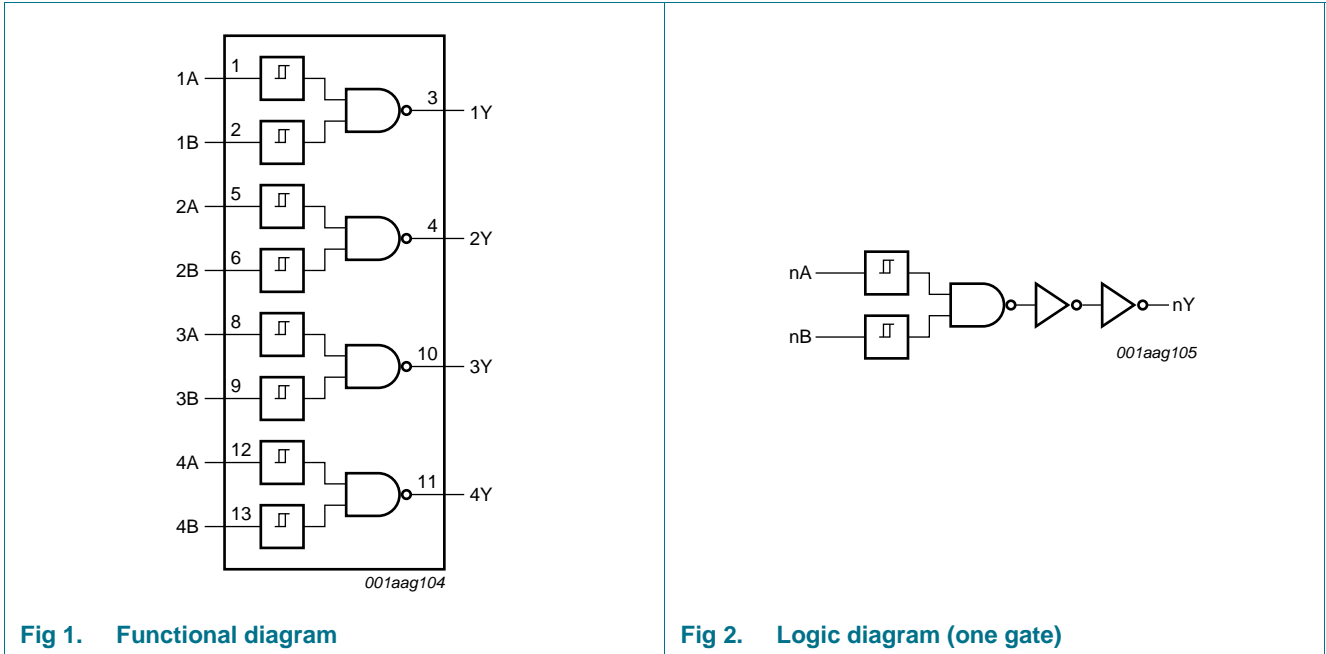

6. Pinning information

6.1 Pinning

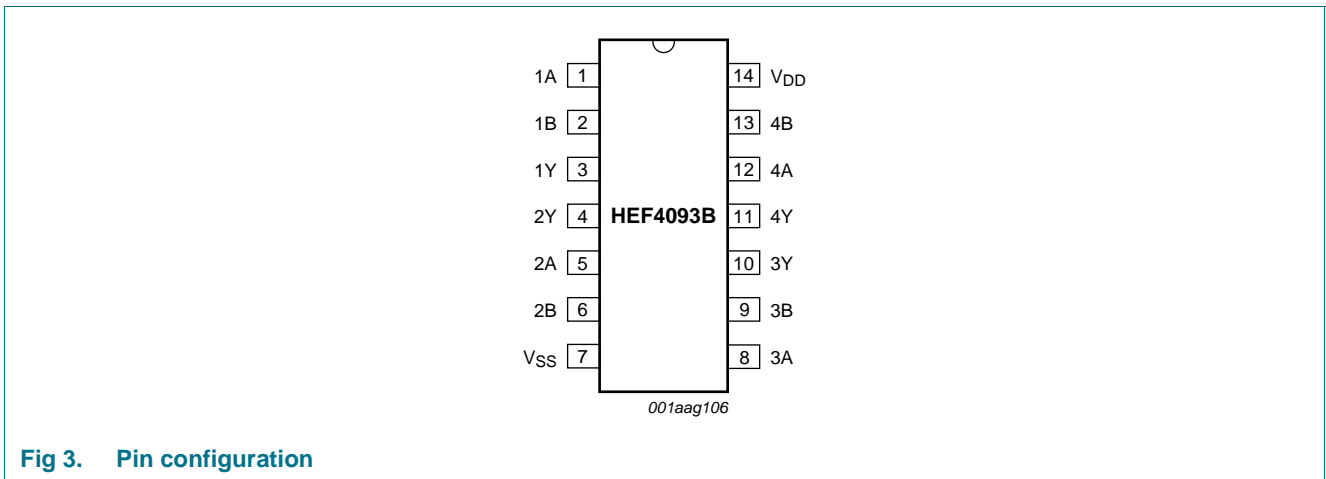

6.2 Pin description

Table 2. Pin description

Symbol	Pin	Description
1A to 4A	1, 5, 8, 12	input
1B to 4B	2, 6, 9, 13	input
1Y to 4Y	3, 4, 10, 11	output
V _{DD}	14	supply voltage
V _{SS}	7	ground (0 V)

7. Functional description

Table 3. Function table^[1]

Input		Output
nA	nB	nY
L	L	H
L	H	H
H	L	H
H	H	L

[1] H = HIGH voltage level; L = LOW voltage level.

8. Limiting values

Table 4. Limiting values

In accordance with the Absolute Maximum Rating System (IEC 60134). Voltages are referenced to V_{SS} = 0 V (ground).

Symbol	Parameter	Conditions	Min	Max	Unit	
V _{DD}	supply voltage		-0.5	+18	V	
I _{IK}	input clamping current	V _I < -0.5 V or V _I > V _{DD} + 0.5 V	-	±10	mA	
V _I	input voltage		-0.5	V _{DD} + 0.5	V	
I _{OK}	output clamping current	V _O < -0.5 V or V _O > V _{DD} + 0.5 V	-	±10	mA	
I _{I/O}	input/output current		-	±10	mA	
I _{DD}	supply current		-	50	mA	
T _{stg}	storage temperature		-65	+150	°C	
T _{amb}	ambient temperature		-40	+125	°C	
P _{tot}	total power dissipation	T _{amb} = -40 °C to +125 °C				
		DIP14	[1]	-	750	mW
		SO14	[2]	-	500	mW
P	power dissipation	per output	-	100	mW	

[1] For DIP14 packages: above T_{amb} = 70 °C, P_{tot} derates linearly with 12 mW/K.

[2] For SO14 packages: above T_{amb} = 70 °C, P_{tot} derates linearly with 8 mW/K.

9. Recommended operating conditions

Table 5. Recommended operating conditions

Symbol	Parameter	Conditions	Min	Max	Unit
V_{DD}	supply voltage		3	15	V
V_I	input voltage		0	V_{DD}	V
T_{amb}	ambient temperature	in free air	-40	+125	°C

10. Static characteristics

Table 6. Static characteristics

$V_{SS} = 0$ V; $V_I = V_{SS}$ or V_{DD} ; unless otherwise specified.

Symbol	Parameter	Conditions	V_{DD}	$T_{amb} = -40$ °C		$T_{amb} = +25$ °C		$T_{amb} = +85$ °C		$T_{amb} = +125$ °C		Unit
				Min	Max	Min	Max	Min	Max	Min	Max	
V_{OH}	HIGH-level output voltage	$ I_O < 1$ μ A	5 V	4.95	-	4.95	-	4.95	-	4.95	-	V
			10 V	9.95	-	9.95	-	9.95	-	9.95	-	V
			15 V	14.95	-	14.95	-	14.95	-	14.95	-	V
V_{OL}	LOW-level output voltage	$ I_O < 1$ μ A	5 V	-	0.05	-	0.05	-	0.05	-	0.05	V
			10 V	-	0.05	-	0.05	-	0.05	-	0.05	V
			15 V	-	0.05	-	0.05	-	0.05	-	0.05	V
I_{OH}	HIGH-level output current	$V_O = 2.5$ V	5 V	-	-1.7	-	-1.4	-	-1.1	-	-1.1	mA
			5 V	-	-0.64	-	-0.5	-	-0.36	-	-0.36	mA
			10 V	-	-1.6	-	-1.3	-	-0.9	-	-0.9	mA
			15 V	-	-4.2	-	-3.4	-	-2.4	-	-2.4	mA
I_{OL}	LOW-level output current	$V_O = 0.4$ V	5 V	0.64	-	0.5	-	0.36	-	0.36	-	mA
			10 V	1.6	-	1.3	-	0.9	-	0.9	-	mA
			15 V	4.2	-	3.4	-	2.4	-	2.4	-	mA
I_I	input leakage current		15 V	-	± 0.1	-	± 0.1	-	± 1.0	-	± 1.0	μ A
I_{DD}	supply current	all valid input combinations; $I_O = 0$ A	5 V	-	0.25	-	0.25	-	7.5	-	7.5	μ A
			10 V	-	0.5	-	0.5	-	15.0	-	15.0	μ A
			15 V	-	1.0	-	1.0	-	30.0	-	30.0	μ A
C_I	input capacitance			-	-	-	7.5	-	-	-	pF	

11. Dynamic characteristics

Table 7. Dynamic characteristics

$T_{amb} = 25\text{ }^{\circ}\text{C}$; $C_L = 50\text{ pF}$; $t_r = t_f \leq 20\text{ ns}$; wave forms see [Figure 4](#); test circuit see [Figure 5](#); unless otherwise specified.

Symbol	Parameter	Conditions	V _{DD}	Extrapolation formula ^[1]	Min	Typ	Max	Unit
t _{PHL}	HIGH to LOW propagation delay	nA or nB to nY	5 V	63 ns + (0.55 ns/pF)C _L	-	90	185	ns
			10 V	29 ns + (0.23 ns/pF)C _L	-	40	80	ns
			15 V	22 ns + (0.16 ns/pF)C _L	-	30	60	ns
t _{PLH}	LOW to HIGH propagation delay	nA or nB to nY	5 V	58 ns + (0.55 ns/pF)C _L	-	85	170	ns
			10 V	29 ns + (0.23 ns/pF)C _L	-	40	80	ns
			15 V	22 ns + (0.16 ns/pF)C _L	-	30	60	ns
t _{THL}	HIGH to LOW output transition time	nY to LOW	5 V	10 ns + (1.00 ns/pF)C _L	-	60	120	ns
			10 V	9 ns + (0.42 ns/pF)C _L	-	30	60	ns
			15 V	6 ns + (0.28 ns/pF)C _L	-	20	40	ns
t _{TLH}	LOW to HIGH output transition time	nA or nB to HIGH	5 V	10 ns + (1.00 ns/pF)C _L	-	60	120	ns
			10 V	9 ns + (0.42 ns/pF)C _L	-	30	60	ns
			15 V	6 ns + (0.28 ns/pF)C _L	-	20	40	ns

[1] Typical value of the propagation delay and output transition time can be calculated with the extrapolation formula (C_L in pF).

Table 8. Dynamic power dissipation

$V_{SS} = 0\text{ V}$; $t_r = t_f \leq 20\text{ ns}$; $T_{amb} = 25\text{ }^{\circ}\text{C}$.

Symbol	Parameter	V _{DD}	Typical formula	where:
P _D	dynamic power dissipation	5 V	$P_D = 1300 \times f_i + \Sigma(f_o \times C_L) \times V_{DD}^2$ (μW)	f_i = input frequency in MHz;
		10 V	$P_D = 6400 \times f_i + \Sigma(f_o \times C_L) \times V_{DD}^2$ (μW)	f_o = output frequency in MHz;
		15 V	$P_D = 18700 \times f_i + \Sigma(f_o \times C_L) \times V_{DD}^2$ (μW)	C _L = output load capacitance in pF; $\Sigma(f_o \times C_L)$ = sum of the outputs; V _{DD} = supply voltage in V.

12. Waveforms

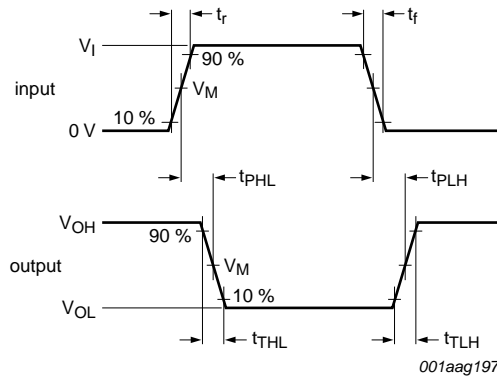

Measurement points are given in [Table 9](#).
 Logic levels: V_{OL} and V_{OH} are typical output voltage levels that occur with the output load.
 t_r , t_f = input rise and fall times.

Fig 4. Propagation delay and output transition time

Table 9. Measurement points

Supply voltage	Input	Output
V_{DD}	V_M	V_M
5 V to 15 V	$0.5V_{DD}$	$0.5V_{DD}$

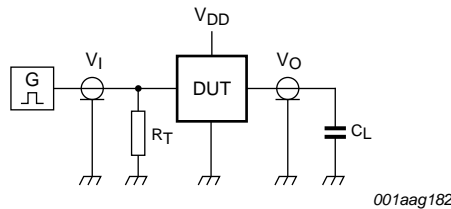

Test data given in [Table 10](#).
 Definitions for test circuit:
 DUT = Device Under Test.
 C_L = load capacitance including jig and probe capacitance.
 R_T = termination resistance should be equal to the output impedance Z_o of the pulse generator.

Fig 5. Test circuit

Table 10. Test data

Supply voltage	Input	Load
V_{DD}	V_I	C_L
5 V to 15 V	V_{SS} or V_{DD}	≤ 20 ns
		50 pF

13. Transfer characteristics

Table 11. Transfer characteristics

$V_{SS} = 0\text{ V}$; $T_{amb} = 25\text{ }^\circ\text{C}$; see [Figure 6](#) and [Figure 7](#).

Symbol	Parameter	Conditions	V_{DD}	Min	Typ	Max	Unit
V_{T+}	positive-going threshold voltage		5 V	1.9	2.9	3.5	V
			10 V	3.6	5.2	7	V
			15 V	4.7	7.3	11	V
V_{T-}	negative-going threshold voltage		5 V	1.5	2.2	3.1	V
			10 V	3	4.2	6.4	V
			15 V	4	6.0	10.3	V
V_H	hysteresis voltage		5 V	0.4	0.7	-	V
			10 V	0.6	1.0	-	V
			15 V	0.7	1.3	-	V

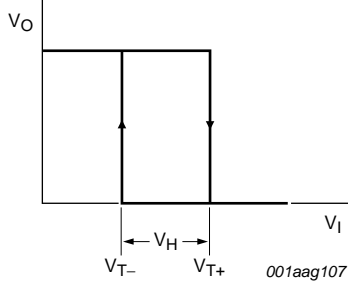

Fig 6. Transfer characteristic

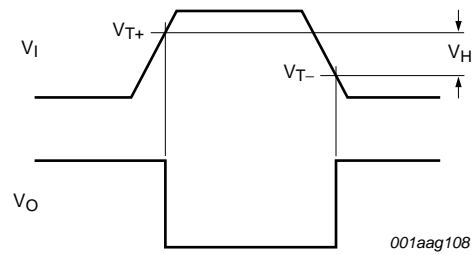
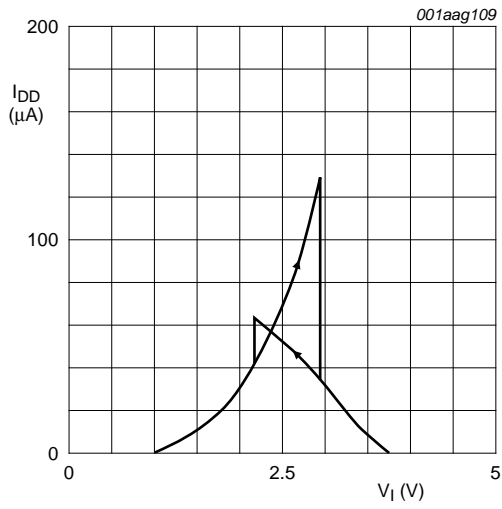
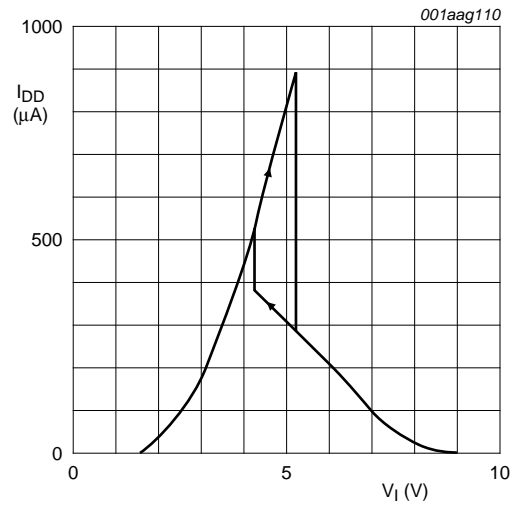

Fig 7. Waveforms showing definition of V_{T+} and V_{T-} (between limits at 30 % and 70 %) and V_H



a. $V_{DD} = 5\text{ V}$; $T_{amb} = 25\text{ }^\circ\text{C}$



b. $V_{DD} = 10\text{ V}$; $T_{amb} = 25\text{ }^\circ\text{C}$

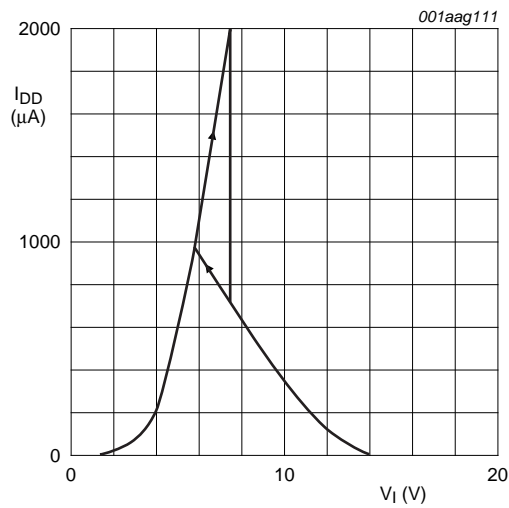

c. $V_{DD} = 15\text{ V}$; $T_{amb} = 25\text{ }^\circ\text{C}$

Fig 8. Typical drain current as a function of input

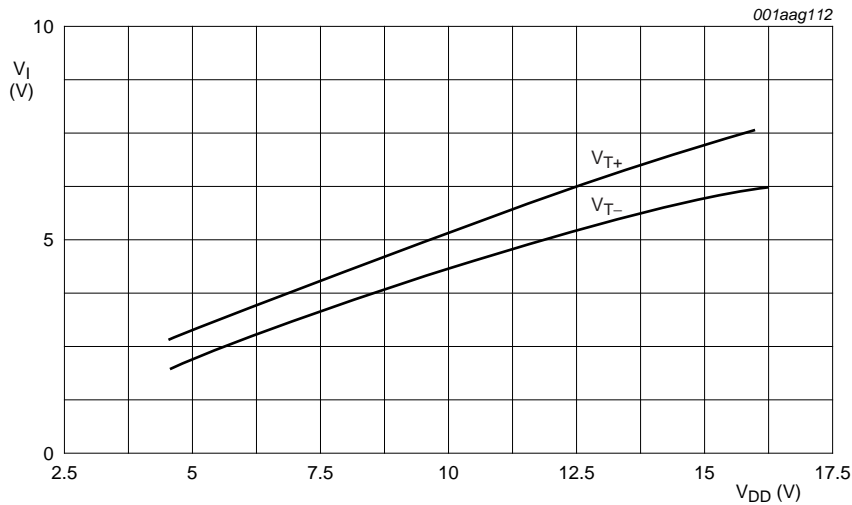

T_{amb} = 25 °C.

Fig 9. Typical switching levels as a function of supply voltage

14. Application information

Some examples of applications for the HEF4093B are:

- Wave and pulse shapers
- Astable multivibrators
- Monostable multivibrators

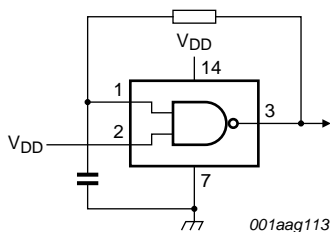

Fig 10. Astable multivibrator

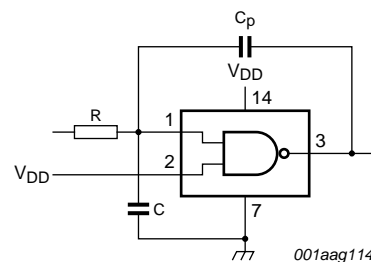

Fig 11. Schmitt trigger driven via a high-impedance input

If a Schmitt trigger is driven via a high-impedance ($R > 1 \text{ k}\Omega$), then it is necessary to incorporate a capacitor C with a value of $\frac{C}{C_p} > \frac{V_{DD} - V_{SS}}{V_H}$; otherwise oscillation can occur on the edges of a pulse.

C_p is the external parasitic capacitance between inputs and output; the value depends on the circuit board layout.

Remark: The two inputs may be connected together, but this will result in a larger through-current at the moment of switching.

15. Package outline

DIP14: plastic dual in-line package; 14 leads (300 mil)

SOT27-1

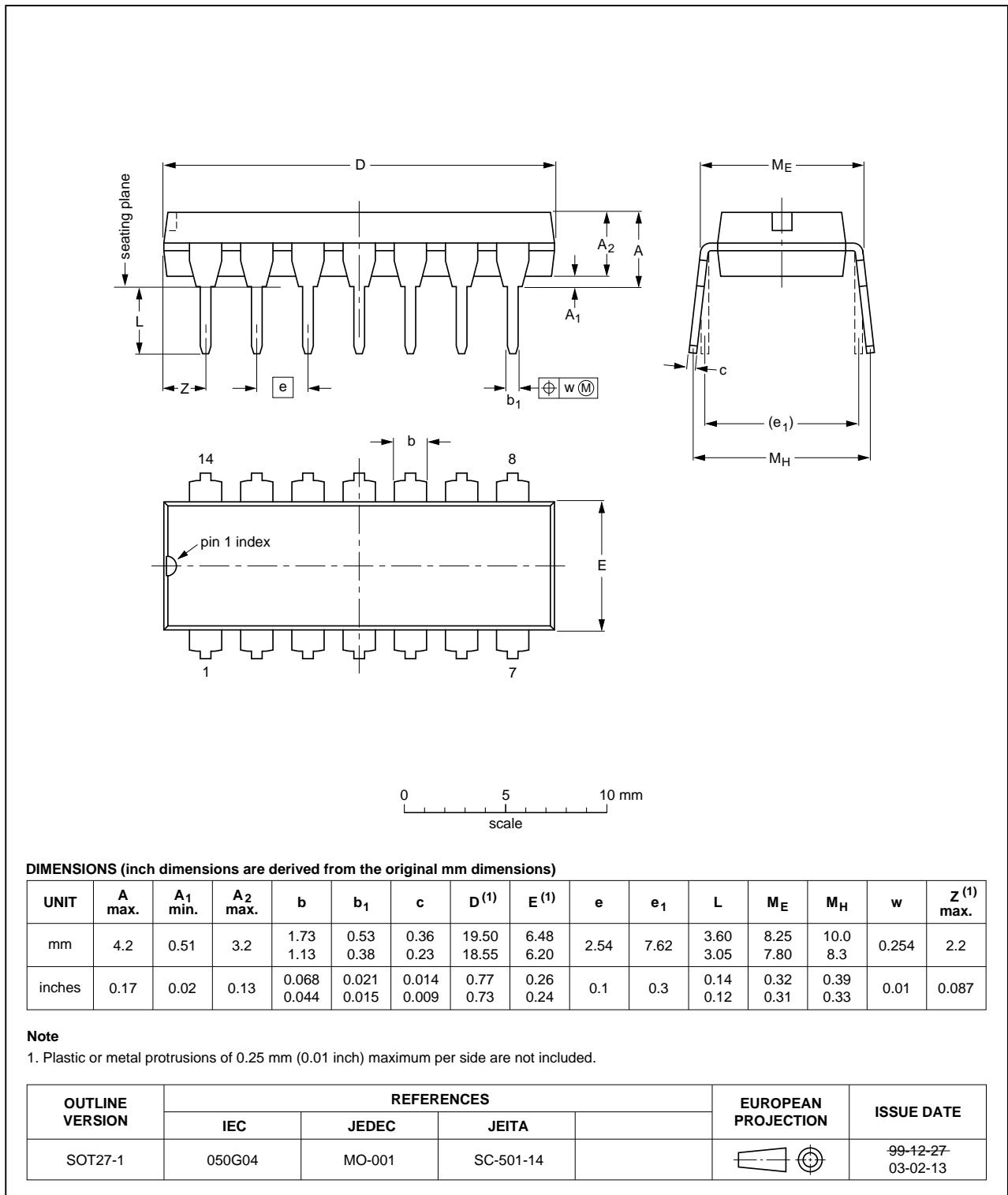

Fig 12. Package outline SOT27-1 (DIP14)

SO14: plastic small outline package; 14 leads; body width 3.9 mm

SOT108-1

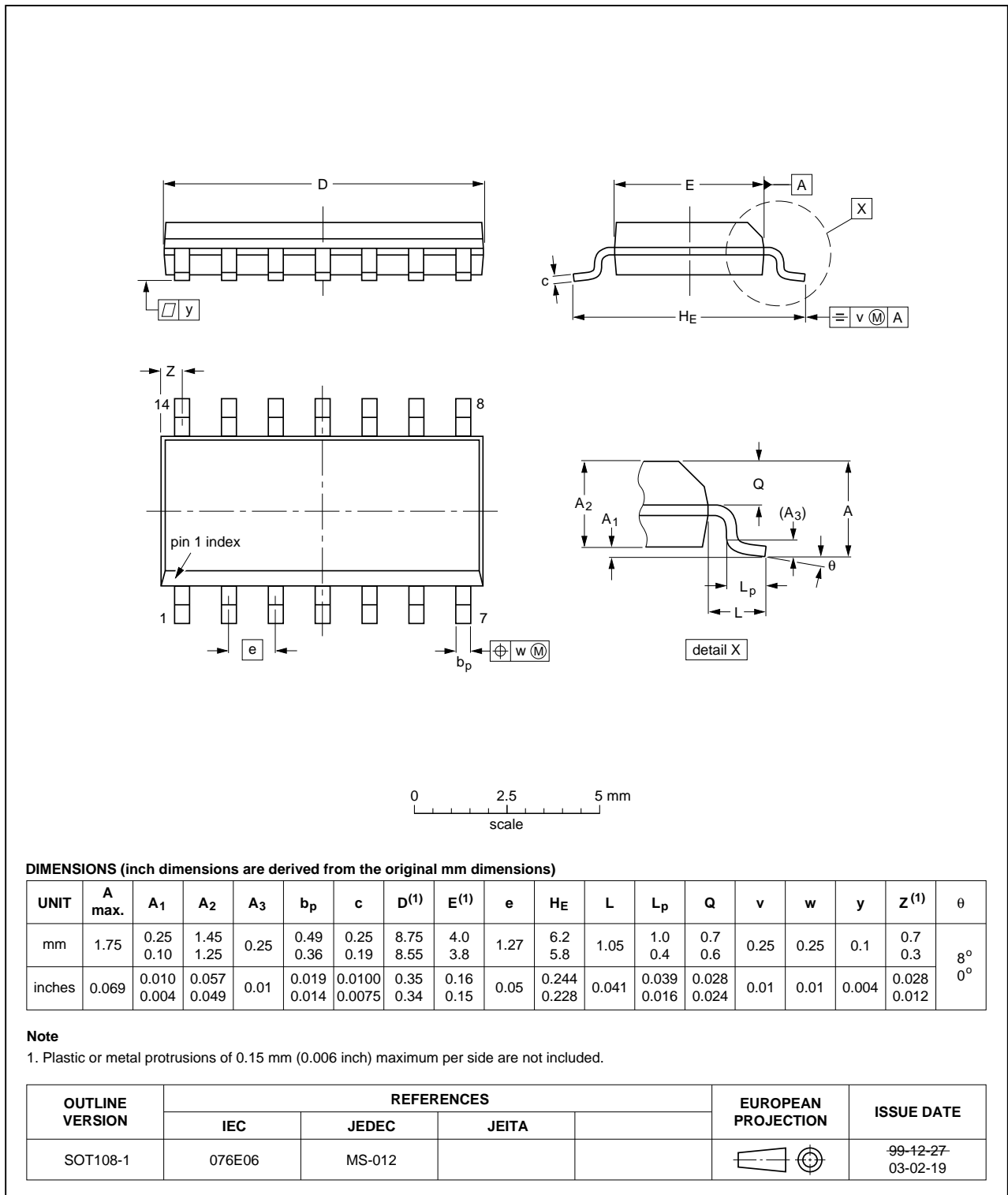

Fig 13. Package outline SOT108-1 (SO14)

16. Revision history

Table 12. Revision history

Document ID	Release date	Data sheet status	Change notice	Supersedes
HEF4093B v.8	20111121	Product data sheet	-	HEF4093B v.7
Modifications:	• Table 6 : I _{OH} minimum values changed to maximum			
HEF4093B v.7	20100901	Product data sheet	-	HEF4093B v.6
HEF4093B v.6	20091202	Product data sheet	-	HEF4093B v.5
HEF4093B v.5	20090728	Product data sheet	-	HEF4093B v.4
HEF4093B v.4	20080612	Product data sheet	-	HEF4093B_CNV v.3
HEF4093B_CNV v.3	19950101	Product specification	-	HEF4093B_CNV v.2
HEF4093B_CNV v.2	19950101	Product specification	-	-

17. Legal information

17.1 Data sheet status

Document status ^{[1][2]}	Product status ^[3]	Definition
Objective [short] data sheet	Development	This document contains data from the objective specification for product development.
Preliminary [short] data sheet	Qualification	This document contains data from the preliminary specification.
Product [short] data sheet	Production	This document contains the product specification.

[1] Please consult the most recently issued document before initiating or completing a design.

[2] The term 'short data sheet' is explained in section "Definitions".

[3] The product status of device(s) described in this document may have changed since this document was published and may differ in case of multiple devices. The latest product status information is available on the Internet at URL <http://www.nxp.com>.

17.2 Definitions

Draft — The document is a draft version only. The content is still under internal review and subject to formal approval, which may result in modifications or additions. NXP Semiconductors does not give any representations or warranties as to the accuracy or completeness of information included herein and shall have no liability for the consequences of use of such information.

Short data sheet — A short data sheet is an extract from a full data sheet with the same product type number(s) and title. A short data sheet is intended for quick reference only and should not be relied upon to contain detailed and full information. For detailed and full information see the relevant full data sheet, which is available on request via the local NXP Semiconductors sales office. In case of any inconsistency or conflict with the short data sheet, the full data sheet shall prevail.

Product specification — The information and data provided in a Product data sheet shall define the specification of the product as agreed between NXP Semiconductors and its customer, unless NXP Semiconductors and customer have explicitly agreed otherwise in writing. In no event however, shall an agreement be valid in which the NXP Semiconductors product is deemed to offer functions and qualities beyond those described in the Product data sheet.

17.3 Disclaimers

Limited warranty and liability — Information in this document is believed to be accurate and reliable. However, NXP Semiconductors does not give any representations or warranties, expressed or implied, as to the accuracy or completeness of such information and shall have no liability for the consequences of use of such information.

In no event shall NXP Semiconductors be liable for any indirect, incidental, punitive, special or consequential damages (including - without limitation - lost profits, lost savings, business interruption, costs related to the removal or replacement of any products or rework charges) whether or not such damages are based on tort (including negligence), warranty, breach of contract or any other legal theory.

Notwithstanding any damages that customer might incur for any reason whatsoever, NXP Semiconductors' aggregate and cumulative liability towards customer for the products described herein shall be limited in accordance with the *Terms and conditions of commercial sale* of NXP Semiconductors.

Right to make changes — NXP Semiconductors reserves the right to make changes to information published in this document, including without limitation specifications and product descriptions, at any time and without notice. This document supersedes and replaces all information supplied prior to the publication hereof.

Suitability for use — NXP Semiconductors products are not designed, authorized or warranted to be suitable for use in life support, life-critical or safety-critical systems or equipment, nor in applications where failure or

malfunction of an NXP Semiconductors product can reasonably be expected to result in personal injury, death or severe property or environmental damage. NXP Semiconductors accepts no liability for inclusion and/or use of NXP Semiconductors products in such equipment or applications and therefore such inclusion and/or use is at the customer's own risk.

Applications — Applications that are described herein for any of these products are for illustrative purposes only. NXP Semiconductors makes no representation or warranty that such applications will be suitable for the specified use without further testing or modification.

Customers are responsible for the design and operation of their applications and products using NXP Semiconductors products, and NXP Semiconductors accepts no liability for any assistance with applications or customer product design. It is customer's sole responsibility to determine whether the NXP Semiconductors product is suitable and fit for the customer's applications and products planned, as well as for the planned application and use of customer's third party customer(s). Customers should provide appropriate design and operating safeguards to minimize the risks associated with their applications and products.

NXP Semiconductors does not accept any liability related to any default, damage, costs or problem which is based on any weakness or default in the customer's applications or products, or the application or use by customer's third party customer(s). Customer is responsible for doing all necessary testing for the customer's applications and products using NXP Semiconductors products in order to avoid a default of the applications and the products or of the application or use by customer's third party customer(s). NXP does not accept any liability in this respect.

Limiting values — Stress above one or more limiting values (as defined in the Absolute Maximum Ratings System of IEC 60134) will cause permanent damage to the device. Limiting values are stress ratings only and (proper) operation of the device at these or any other conditions above those given in the Recommended operating conditions section (if present) or the Characteristics sections of this document is not warranted. Constant or repeated exposure to limiting values will permanently and irreversibly affect the quality and reliability of the device.

Terms and conditions of commercial sale — NXP Semiconductors products are sold subject to the general terms and conditions of commercial sale, as published at <http://www.nxp.com/profile/terms>, unless otherwise agreed in a valid written individual agreement. In case an individual agreement is concluded only the terms and conditions of the respective agreement shall apply. NXP Semiconductors hereby expressly objects to applying the customer's general terms and conditions with regard to the purchase of NXP Semiconductors products by customer.

No offer to sell or license — Nothing in this document may be interpreted or construed as an offer to sell products that is open for acceptance or the grant, conveyance or implication of any license under any copyrights, patents or other industrial or intellectual property rights.

Export control — This document as well as the item(s) described herein may be subject to export control regulations. Export might require a prior authorization from competent authorities.

Non-automotive qualified products — Unless this data sheet expressly states that this specific NXP Semiconductors product is automotive qualified, the product is not suitable for automotive use. It is neither qualified nor tested in accordance with automotive testing or application requirements. NXP Semiconductors accepts no liability for inclusion and/or use of non-automotive qualified products in automotive equipment or applications.

In the event that customer uses the product for design-in and use in automotive applications to automotive specifications and standards, customer (a) shall use the product without NXP Semiconductors' warranty of the product for such automotive applications, use and specifications, and (b) whenever customer uses the product for automotive applications beyond

NXP Semiconductors' specifications such use shall be solely at customer's own risk, and (c) customer fully indemnifies NXP Semiconductors for any liability, damages or failed product claims resulting from customer design and use of the product for automotive applications beyond NXP Semiconductors' standard warranty and NXP Semiconductors' product specifications.

17.4 Trademarks

Notice: All referenced brands, product names, service names and trademarks are the property of their respective owners.

18. Contact information

For more information, please visit: <http://www.nxp.com>

For sales office addresses, please send an email to: salesaddresses@nxp.com

19. Contents

1	General description	1
2	Features and benefits	1
3	Applications	1
4	Ordering information	1
5	Functional diagram	2
6	Pinning information	2
6.1	Pinning	2
6.2	Pin description	3
7	Functional description	3
8	Limiting values	3
9	Recommended operating conditions	4
10	Static characteristics	4
11	Dynamic characteristics	5
12	Waveforms	6
13	Transfer characteristics	7
14	Application information	9
15	Package outline	10
16	Revision history	12
17	Legal information	13
17.1	Data sheet status	13
17.2	Definitions	13
17.3	Disclaimers	13
17.4	Trademarks	14
18	Contact information	14
19	Contents	15

Please be aware that important notices concerning this document and the product(s) described herein, have been included in section 'Legal information'.

© NXP B.V. 2011.

All rights reserved.

For more information, please visit: <http://www.nxp.com>

For sales office addresses, please send an email to: salesaddresses@nxp.com

Date of release: 21 November 2011

Document identifier: HEF4093B

Mouser Electronics

Authorized Distributor

Click to View Pricing, Inventory, Delivery & Lifecycle Information:

[NXP:](#)

[HEF4093BP,652](#) [HEF4093BT,652](#) [HEF4093BT,653](#)