

MAX941/MAX942/ MAX944

High-Speed, Low-Power, 3V/5V, Rail-to-Rail, Single-Supply Comparators

General Description

The MAX941/MAX942/MAX944 are single/dual/quad high-speed comparators optimized for systems powered from a 3V or 5V supply. These devices combine high speed, low power, and rail-to-rail inputs. Propagation delay is 80ns, while supply current is only 350µA per comparator.

The input common-mode range of the MAX941/MAX942/MAX944 extends beyond both power-supply rails. The outputs pull to within 0.4V of either supply rail without external pullup circuitry, making these devices ideal for interface with both CMOS and TTL logic. All input and output pins can tolerate a continuous short-circuit fault condition to either rail. Internal hysteresis ensures clean output switching, even with slow-moving input signals. The MAX941 features latch enable and device shutdown.

The single MAX941 and dual MAX942 are offered in a tiny µMAX® package. Both the single and dual MAX942 are available in 8-pin DIP and SO packages. The quad MAX944 comes in 14-pin DIP and narrow SO packages.

Applications

- 3V/5V Systems
- Battery-Powered Systems
- Threshold Detectors/Discriminators
- Line Receivers
- Zero-Crossing Detectors
- Sampling Circuits

Features

- Available in µMAX Package
- Optimized for 3V and 5V Applications (Operation Down to 2.7V)
- Fast, 80ns Propagation Delay (5mV Overdrive)
- Rail-to-Rail Input Voltage Range
- Low 350µA Supply Current per Comparator
- Low, 1mV Offset Voltage
- Internal Hysteresis for Clean Switching
- Outputs Swing 200mV of Power Rails
- CMOS/TTL-Compatible Outputs
- Output Latch (MAX941 Only)
- Shutdown Function (MAX941 Only)

Ordering Information

PART	TEMP RANGE	PIN-PACKAGE
MAX941CPA	0°C to +70°C	8 PDIP
MAX941CSA	0°C to +70°C	8 SO
MAX941EPA	-40°C to +85°C	8 PDIP
MAX941ESA	-40°C to +85°C	8 SO
MAX941EUA-T	-40°C to +85°C	8 µMAX
MAX941AUA-T	-40°C to +125°C	8 µMAX

T = Tape and reel.

Ordering Information continued at end of data sheet.

µMAX is a registered trademark of Maxim Integrated Products, Inc.

Pin Configurations

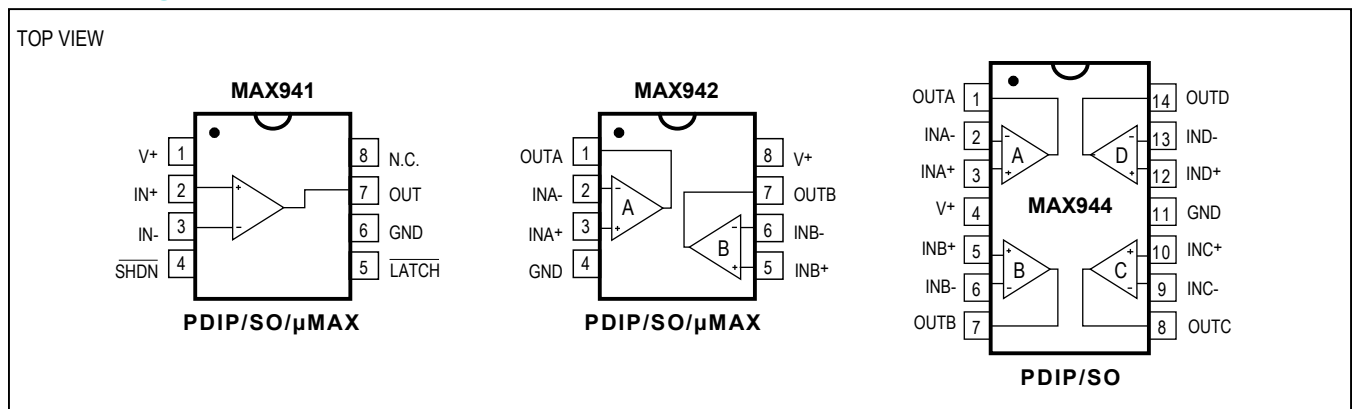

MAX941/MAX942/ MAX944

High-Speed, Low-Power, 3V/5V, Rail-to-Rail, Single-Supply Comparators

Absolute Maximum Ratings

Power-Supply Ranges

Supply Voltage $V+$ to GND	+6.5V
Differential Input Voltage	-0.3V to ($V+ + 0.3V$)
Common-Mode Input Voltage	-0.3V to ($V+ + 0.3V$)
LATCH Input (MAX941 only)	-0.3V to ($V+ + 0.3V$)
SHDN Control Input (MAX941 only)	-0.3V to ($V+ + 0.3V$)

Current Into Input Pins $\pm 20\text{mA}$

Continuous Power Dissipation ($T_A = +70^\circ\text{C}$)

8-Pin Plastic DIP (derate 9.09mW/ $^\circ\text{C}$ above $+70^\circ\text{C}$)	..727mW
8-Pin SO (derate 5.88mW/ $^\circ\text{C}$ above $+70^\circ\text{C}$)471mW

8-Pin μMAX (derate 4.1mW/ $^\circ\text{C}$ above $+70^\circ\text{C}$)330mW
14-Pin Plastic DIP (derate 10.00mW/ $^\circ\text{C}$ above $+70^\circ\text{C}$)	..800mW
14-Pin SO (derate 8.33mW/ $^\circ\text{C}$ above $+70^\circ\text{C}$)667mW

Operating Temperature Ranges

MAX94_C_ 0°C to $+70^\circ\text{C}$
MAX94_E_ -40°C to $+85^\circ\text{C}$
MAX94_AUA -40°C to $+125^\circ\text{C}$
MAX942MSA -55°C to $+125^\circ\text{C}$
Storage Temperature Range -65°C to $+150^\circ\text{C}$
Lead Temperature (soldering, 10s) $+300^\circ\text{C}$

Stresses beyond those listed under "Absolute Maximum Ratings" may cause permanent damage to the device. These are stress ratings only, and functional operation of the device at these or any other conditions beyond those indicated in the operational sections of the specifications is not implied. Exposure to absolute maximum rating conditions for extended periods may affect device reliability.

Electrical Characteristics

($V+ = 2.7\text{V}$ to 5.5V , $T_A = T_{\text{MIN}}$ to T_{MAX} , unless otherwise noted. Typical values are at $T_A = +25^\circ\text{C}$.) (Note 14)

PARAMETER	SYMBOL	CONDITIONS		MIN	TYP	MAX	UNITS	
Positive Supply Voltage	$V+$			2.7		5.5	V	
Input Voltage Range	V_{CMR}	(Note 1)		-0.2		$V+ + 0.2$	V	
Input-Referred Trip Points	V_{TRIP}	$V_{\text{CM}} = 0\text{V}$ or $V_{\text{CM}} = V+$ (Note 2)	$T_A = +25^\circ\text{C}$	MAX94_C_ , MAX94_EP_ , MAX94_ES_ , MAX942MSA	1	3	mV	
			$T_A = T_{\text{MIN}}$ to T_{MAX}	MAX941_UA/MAX942_UA	1	4		
		$T_A = +25^\circ\text{C}$	$T_A = T_{\text{MIN}}$ to T_{MAX}	MAX94_C_ , MAX94_EP_ , MAX94_ES_ , MAX942MSA		4		mV
				MAX941_UA/MAX942_UA		6		
Input Offset Voltage	V_{OS}	$V_{\text{CM}} = 0\text{V}$ or $V_{\text{CM}} = V+$ (Note 3)	$T_A = +25^\circ\text{C}$	MAX94_C_ , MAX94_EP_ , MAX94_ES_ , MAX942MSA	1	2	mV	
			$T_A = T_{\text{MIN}}$ to T_{MAX}	MAX941_UA/MAX942_UA	1	3		
		$T_A = +25^\circ\text{C}$	$T_A = T_{\text{MIN}}$ to T_{MAX}	MAX94_C_ , MAX94_EP_ , MAX94_ES_ , MAX942MSA		3		mV
				MAX941_UA/MAX942_UA		5.5		
Input Bias Current	I_{B}	$V_{\text{IN}} = V_{\text{OS}}$, $V_{\text{CM}} = 0\text{V}$ or $V_{\text{CM}} = V+$ (Note 4)	MAX94_C		150	300	nA	
			MAX94_E/A, MAX942MSA		150	400		
Input Offset Current	I_{OS}	$V_{\text{IN}} = V_{\text{OS}}$, $V_{\text{CM}} = 0\text{V}$ or $V+$			10	150	nA	
Input Differential Clamp Voltage	V_{CLAMP}	Force $100\mu\text{A}$ into $\text{IN}+$, $\text{IN}- = \text{GND}$, measure $V_{\text{IN}+} - V_{\text{IN}-}$, Figure 3			2.2		V	
Common-Mode Rejection Ratio	CMRR	(Note 5)	MAX94_C_ , MAX94_EP_ , MAX94_ES_ , MAX942MSA		80	300	$\mu\text{V}/\text{V}$	
			MAX941_UA/MAX942_UA		80	800		
Power-Supply Rejection Ratio	PSRR	$2.7\text{V} \leq V+ \leq 5.5\text{V}$, $V_{\text{CM}} = 0\text{V}$	MAX94_C_ , MAX94_EP_ , MAX94_ES_ , MAX942MSA		80	300	$\mu\text{V}/\text{V}$	
			MAX941_UA/MAX942_UA		80	350		
Output High Voltage	V_{OH}	$I_{\text{SOURCE}} = 400\mu\text{A}$		$V+ - 0.4$	$V+ - 0.2$		V	
		$I_{\text{SOURCE}} = 4\text{mA}$		$V+ - 0.4$	$V+ - 0.3$			
Output Low Voltage	V_{OL}	$I_{\text{SINK}} = 400\mu\text{A}$			0.2	0.4	V	
		$I_{\text{SINK}} = 4\text{mA}$			0.3	0.4		
Output Leakage Current	I_{LEAK}	(Note 6)				1	μA	

Electrical Characteristics (continued)

(V+ = 2.7V to 5.5V, T_A = T_{MIN} to T_{MAX}, unless otherwise noted. Typical values are at T_A = +25°C.) (Note 14)

PARAMETER	SYMBOL	CONDITIONS	MIN	TYP	MAX	UNITS
Supply Current per Comparator	I _{CC}	V+ = 3V	MAX941	380	600	μA
			MAX942/MAX944	350	500	
		V+ = 5V	MAX941	430	700	
			MAX942/MAX944	400	600	
		MAX941 only, shutdown mode (V+ = 3V)	12	60		
Power Dissipation per Comparator	PD	(Note 7)	MAX941	1.0	4.2	mW
			MAX942/MAX944	1.0	3.6	
Propagation Delay	t _{PD+} , t _{PD-}	(Note 8)	MAX94_C	80	150	ns
			MAX94_E/A, MAX942MSA	80	200	
Differential Propagation Delay	dt _{PD}	(Note 9)		10		ns
Propagation Delay Skew		(Note 10)		10		ns
Logic-Input Voltage High	V _{IH}	(Note 11)	V+/2 + 0.4			V
Logic-Input Voltage Low	V _{IL}	(Note 11)	V+/2 - 0.4			V
Logic-Input Current	I _{IL} , I _{IH}	V _{LOGIC} = 0V or V+ (Note 11)		2	10	μA
Data-to-Latch Setup Time	t _S	(Note 12)		20		ns
Latch-to-Data Hold Time	t _H	(Note 12)		30		ns
Latch Pulse Width	t _{LPW}	MAX941 only		50		ns
Latch Propagation Delay	t _{LPD}	MAX941 only		70		ns
Shutdown Time		(Note 13)		3		ns
Shutdown Disable Time		(Note 13)		10		ns

- Note 1:** Inferred from the CMRR test. Note also that either or both inputs can be driven to the absolute maximum limit (0.3V beyond either supply rail) without damage or false output inversion.
- Note 2:** The input-referred trip points are the extremities of the differential input voltage required to make the comparator output change state. The difference between the upper and lower trip points is equal to the width of the input-referred hysteresis zone (see Figure 1).
- Note 3:** V_{OS} is defined as the center of the input-referred hysteresis zone (see Figure 1).
- Note 4:** The polarity of IB reverses direction as V_{CM} approaches either supply rail. See *Typical Operating Characteristics* for more detail.
- Note 5:** Specified over the full common-mode range (V_{CMR}).
- Note 6:** Applies to the MAX941 only when in shutdown mode. Specification is for current flowing into or out of the output pin for V_{OUT} driven to any voltage from V+ to GND.
- Note 7:** Typical power dissipation specified with V+ = 3V; maximum with V+ = 5.5V.
- Note 8:** Parameter is guaranteed by design and specified with V_{OD} = 5mV and C_{LOAD} = 15pF in parallel with 400μA of sink or source current. V_{OS} is added to the overdrive voltage for low values of overdrive (see Figure 2).
- Note 9:** Specified between any two channels in the MAX942/MAX944.
- Note 10:** Specified as the difference between t_{PD+} and t_{PD-} for any one comparator.
- Note 11:** Applies to the MAX941 only for both SHDN and LATCH pins.
- Note 12:** Applies to the MAX941 only. Comparator is active with LATCH pin driven high and is latched with LATCH pin driven low (see Figure 2).
- Note 13:** Applicable to the MAX941 only. Comparator is active with SHDN pin driven high and is in shutdown with SHDN pin driven low. Shutdown disable time is the delay when SHDN is driven high to the time the output is valid.
- Note 14:** The MAX941_UA and MAX942_UA are 100% production tested at T_A = +25°C. Specifications over temperature are guaranteed by design.

Typical Operating Characteristics

(V+ = 3.0V, T_A = +25°C, unless otherwise noted.)

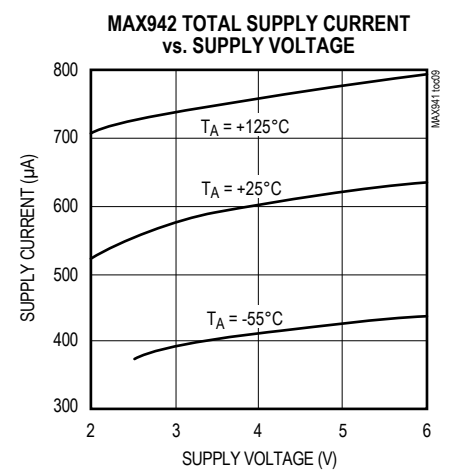
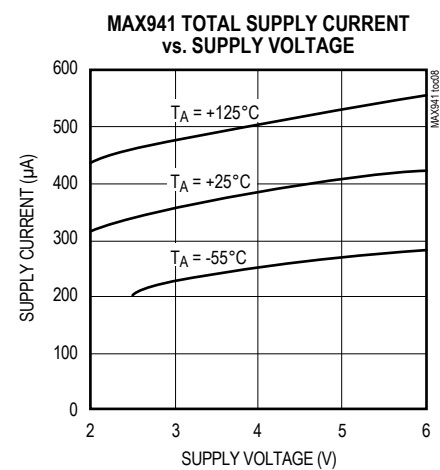
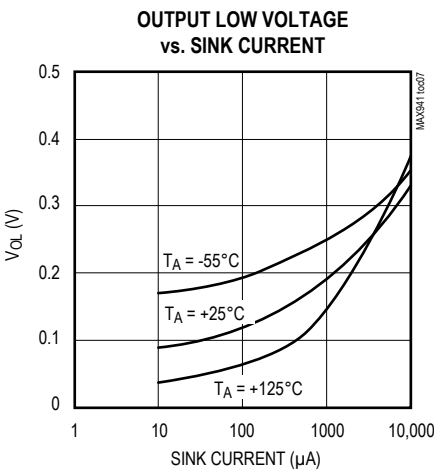
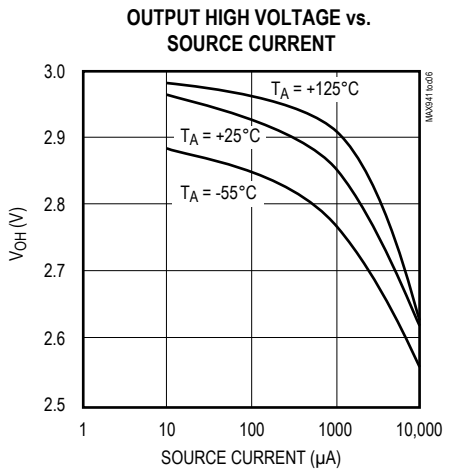
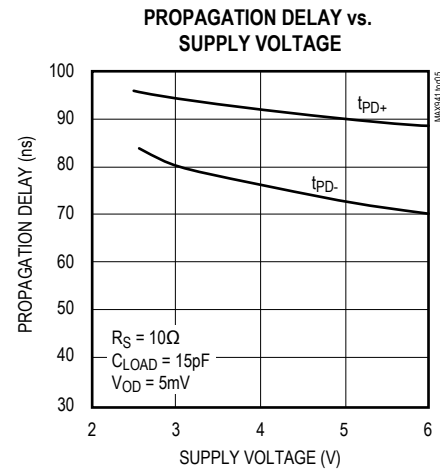
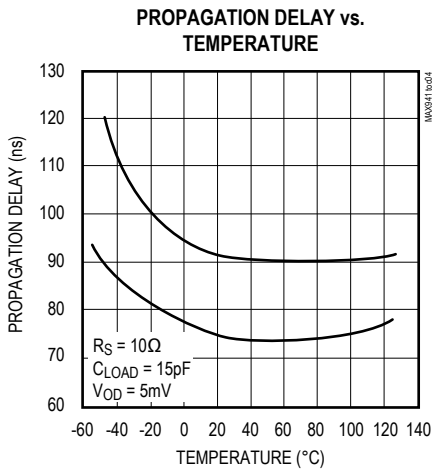
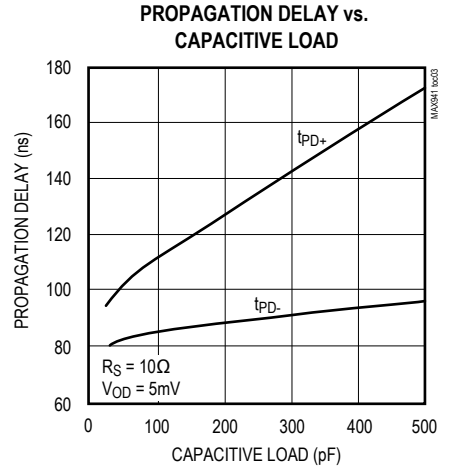
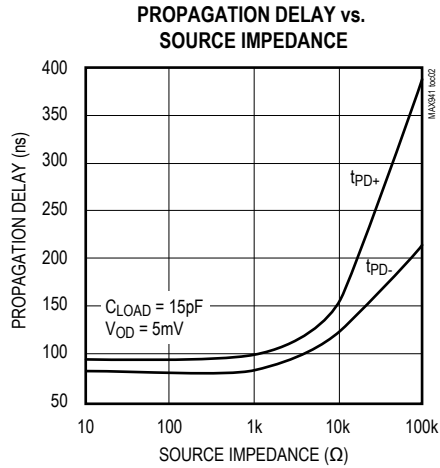
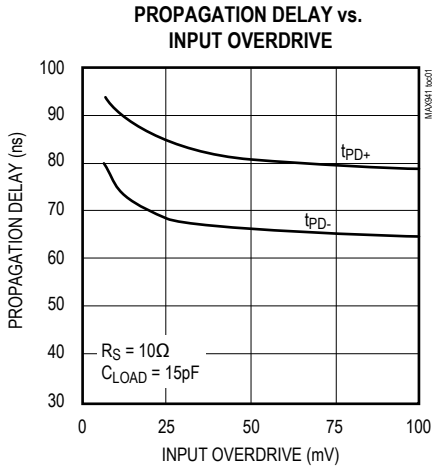

Typical Operating Characteristics (continued)

($V_+ = 3.0V$, $T_A = +25^\circ C$, unless otherwise noted.)

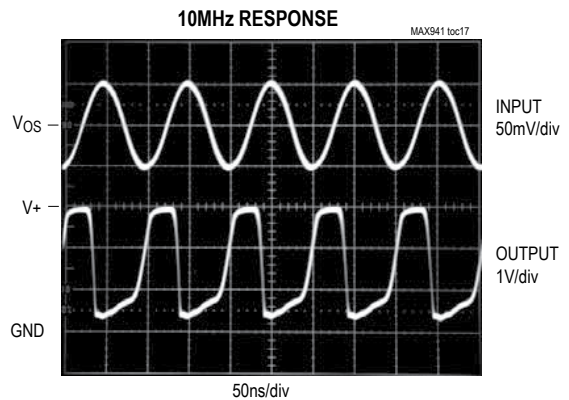
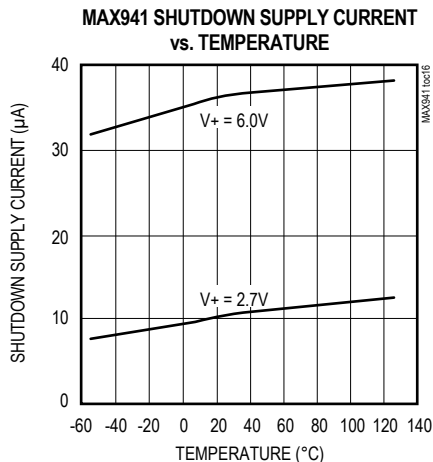
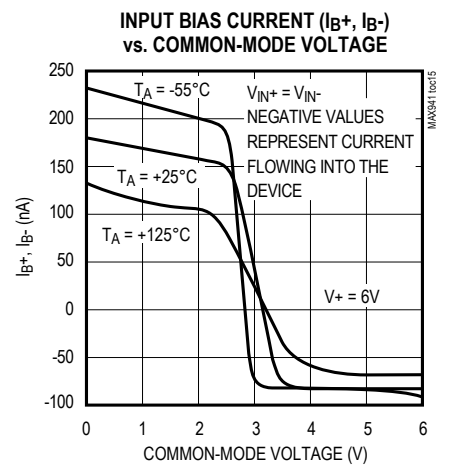
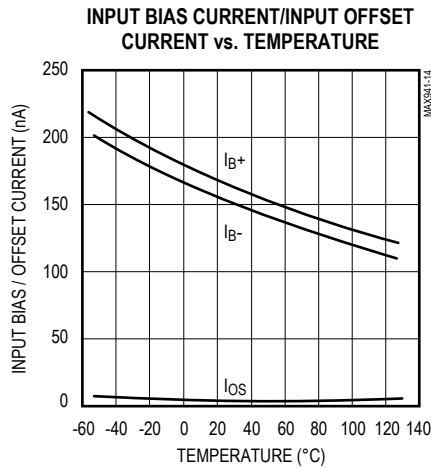
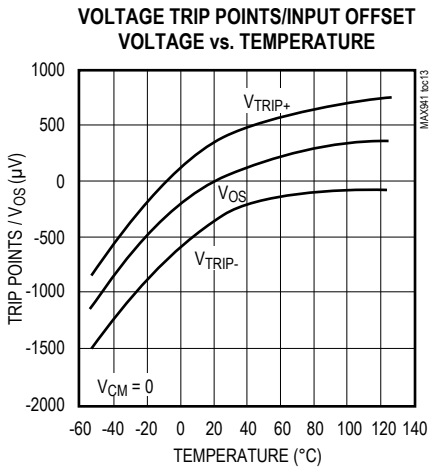
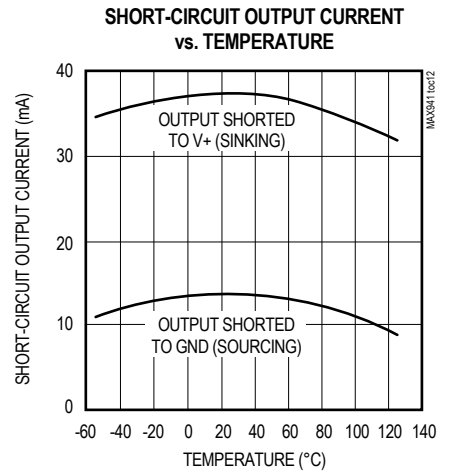
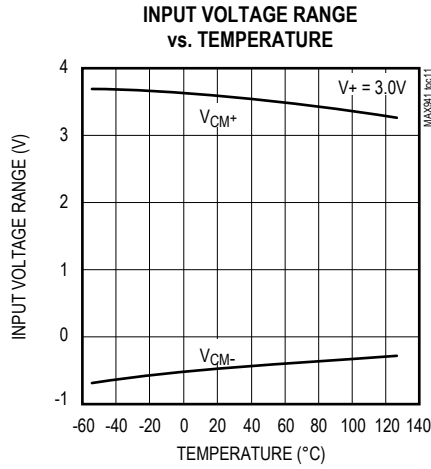
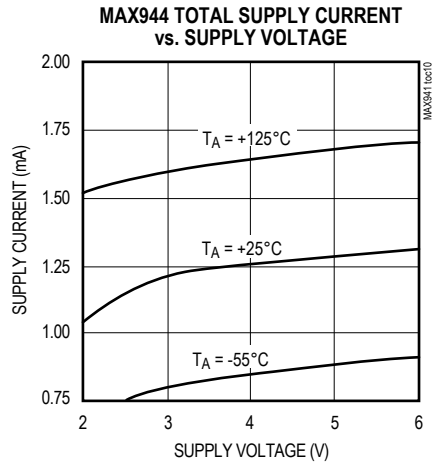

Typical Operating Characteristics (continued)

(V+ = 3.0V, TA = +25°C, unless otherwise noted.)

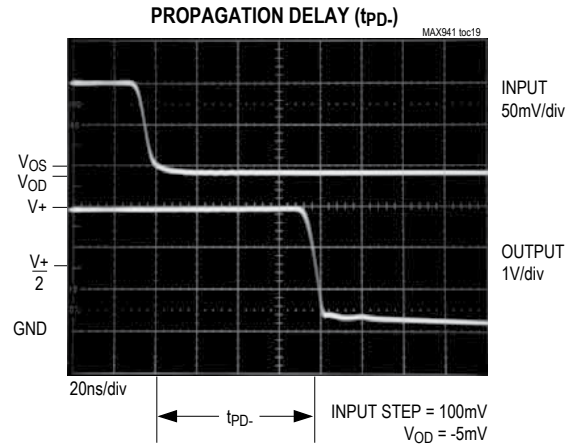
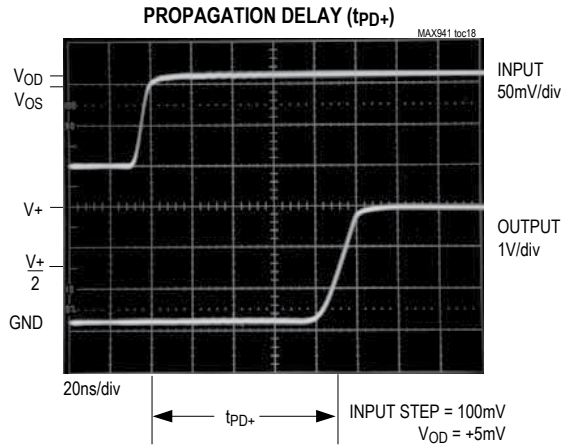

Pin Description

PIN			NAME	FUNCTION
MAX941	MAX942	MAX944		
—	1	1	OUTA	Comparator A Output
—	2	2	INA-	Comparator A Inverting Input
—	3	3	INA+	Comparator A Noninverting Input
1	8	4	V+	Positive Supply (V+ to GND must be ≤ 6.5V)
—	5	5	INB+	Comparator B Noninverting Input
—	6	6	INB-	Comparator B Inverting Input
—	7	7	OUTB	Comparator B Output
—	—	8	OUTC	Comparator C Output
—	—	9	INC-	Comparator C Inverting Input
—	—	10	INC+	Comparator C Noninverting Input
6	4	11	GND	Ground
—	—	12	IND+	Comparator D Noninverting Input
—	—	13	IND-	Comparator D Inverting Input
—	—	14	OUTD	Comparator D Output
2	—	—	IN+	Noninverting Input
3	—	—	IN-	Inverting Input
4	—	—	SHDN	Shutdown: MAX941 is active when SHDN is driven high; MAX941 is in shutdown when SHDN is driven low.
5	—	—	LATCH	The output is latched when LATCH is low. The latch is transparent when LATCH is high.
7	—	—	OUT	Comparator Output
8	—	—	N.C.	No Connection. Not internally connected.

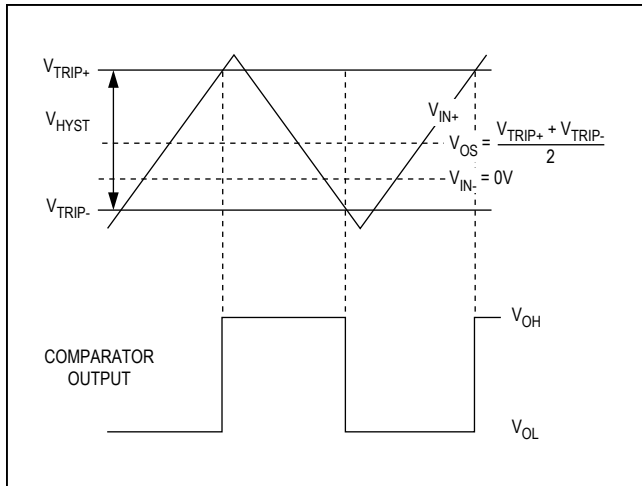

Figure 1. Input and Output Waveform, Noninverting Input Varied

Detailed Description

The MAX941/MAX942/MAX944 single-supply comparators feature internal hysteresis, high speed, and low power. Their outputs are guaranteed to pull within 0.4V of either supply rail without external pullup or pulldown circuitry. Rail-to-rail input voltage range and low-voltage single-supply operation make these devices ideal for portable equipment. The MAX941/MAX942/MAX944 interface directly to CMOS and TTL logic.

Timing

Most high-speed comparators oscillate in the linear region because of noise or undesired parasitic feedback. This tends to occur when the voltage on one input is at or equal to the voltage on the other input. To counter the parasitic effects and noise, the MAX941/MAX942/MAX944 have internal hysteresis.

The hysteresis in a comparator creates two trip points: one for the rising input voltage and one for the falling input voltage (Figure 1). The difference between the trip points is the hysteresis. When the comparator's input voltages are equal, the hysteresis effectively causes one comparator input voltage to move quickly past the other, thus taking the input out of the region where oscillation occurs. Standard comparators require hysteresis to be added with external resistors. The MAX941/MAX942/MAX944's

fixed internal hysteresis eliminates these resistors and the equations needed to determine appropriate values.

Figure 1 illustrates the case where IN- is fixed and IN+ is varied. If the inputs were reversed, the figure would look the same, except the output would be inverted.

The MAX941 includes an internal latch that allows storage of comparison results. The LATCH pin has a high input impedance. If LATCH is high, the latch is transparent (i.e., the comparator operates as though the latch is not present). The comparator's output state is stored when LATCH is pulled low. All timing constraints must be met when using the latch function (Figure 2).

Shutdown Mode (MAX941 Only)

The MAX941 shuts down when SHDN is low. When shut down, the supply current drops to less than 60µA, and the three-state output becomes high impedance. The SHDN pin has a high input impedance. Connect SHDN to V+ for normal operation. Exit shutdown with LATCH high; otherwise, the output will be indeterminate.

Input Stage Circuitry

The MAX941/MAX942/MAX944 include internal protection circuitry that prevents damage to the precision input stage from large differential input voltages. This protection circuitry consists of two back-to-back diodes between IN+ and IN- as well as two 4.1kΩ resistors (Figure 3). The diodes limit the differential voltage applied to the internal circuitry of the comparators to be no more than 2VF, where VF is the forward voltage drop of the diode (about 0.7V at +25°C).

For a large differential input voltage (exceeding 2VF), this protection circuitry increases the input bias current at IN+ (source) and IN- (sink).

$$\text{Input Current} = \frac{(\text{IN}+ - \text{IN}-) - 2V_F}{2 \times 4.1\text{k}\Omega}$$

Input current with large differential input voltages should not be confused with input bias current (IB). As long as the differential input voltage is less than 2VF, this input current is equal to IB. The protection circuitry also allows for the input common-mode range of the MAX941/MAX942/MAX944 to extend beyond both power-supply rails. The output is in the correct logic state if one or both inputs are within the common-mode range.

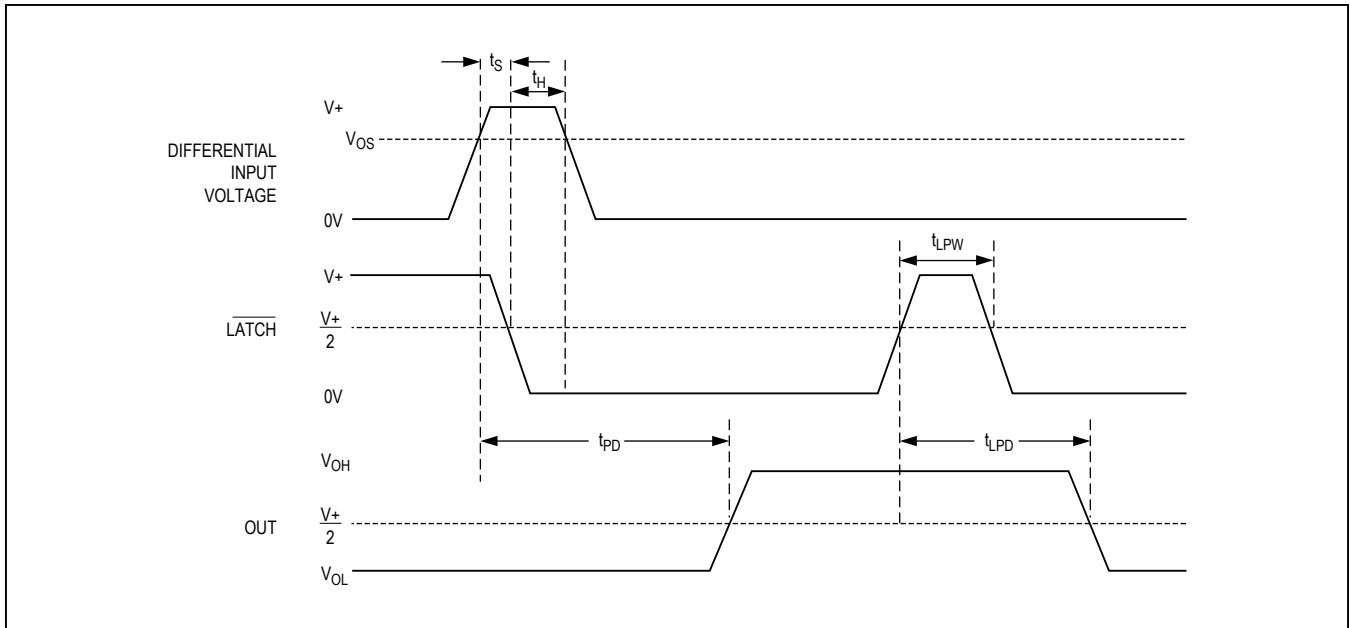

Figure 2. MAX941 Timing Diagram with Latch Operator

Output Stage Circuitry

The MAX941/MAX942/MAX944 contain a current-driven output stage as shown in Figure 4. During an output transition, I_{SOURCE} or I_{SINK} is pushed or pulled to the output pin. The output source or sink current is high during the transition, creating a rapid slew rate. Once the output voltage reaches V_{OH} or V_{OL} , the source or sink current decreases to a small value, capable of maintaining the V_{OH} or V_{OL} static condition. This significant decrease in current conserves power after an output transition has occurred.

One consequence of a current-driven output stage is a linear dependence between the slew rate and the load capacitance. A heavy capacitive load will slow down a voltage output transition. This can be useful in noisesensitive applications where fast edges may cause interference.

Applications Information

Circuit Layout and Bypassing

The high gain bandwidth of the MAX941/MAX942/MAX944 requires design precautions to realize the comparators' full high-speed capability. The recommended precautions are:

- 1) Use a printed circuit board with a good, unbroken, low-inductance ground plane.
- 2) Place a decoupling capacitor (a $0.1\mu\text{F}$ ceramic capacitor is a good choice) as close to $V+$ as possible.
- 3) Pay close attention to the decoupling capacitor's bandwidth, keeping leads short.
- 4) On the inputs and outputs, keep lead lengths short to avoid unwanted parasitic feedback around the comparators.
- 5) Solder the device directly to the printed circuit board instead of using a socket.

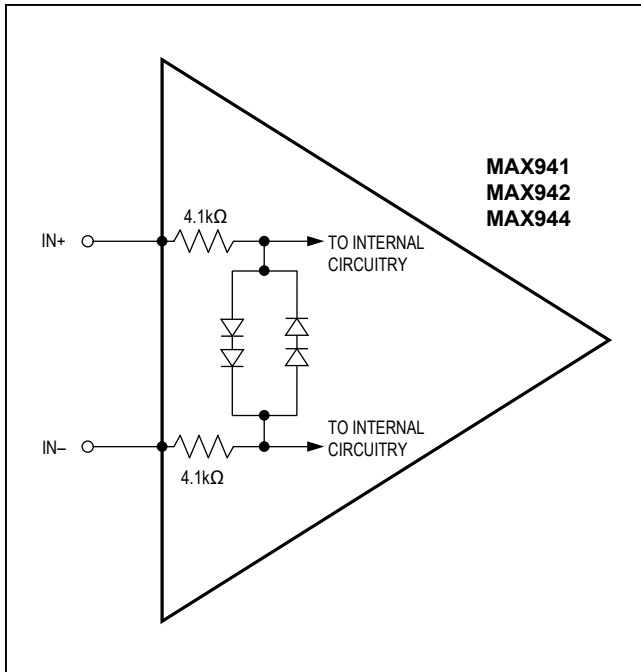

Figure 3. Input Stage Circuitry

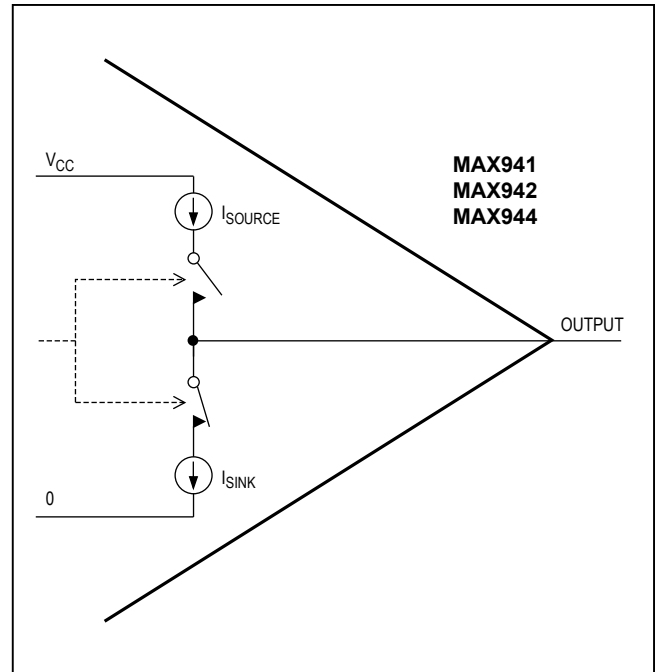

Figure 4. Output Stage Circuitry

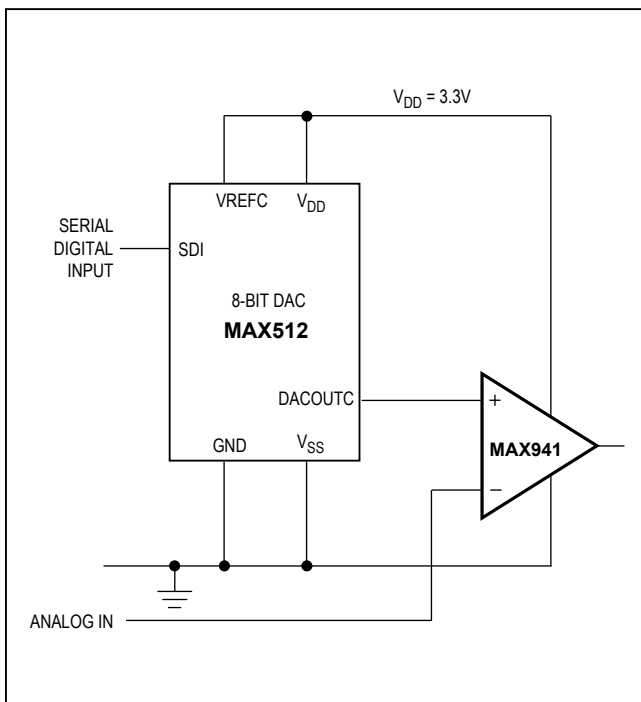

Figure 5. 3.3V Digitally Controlled Threshold Detector

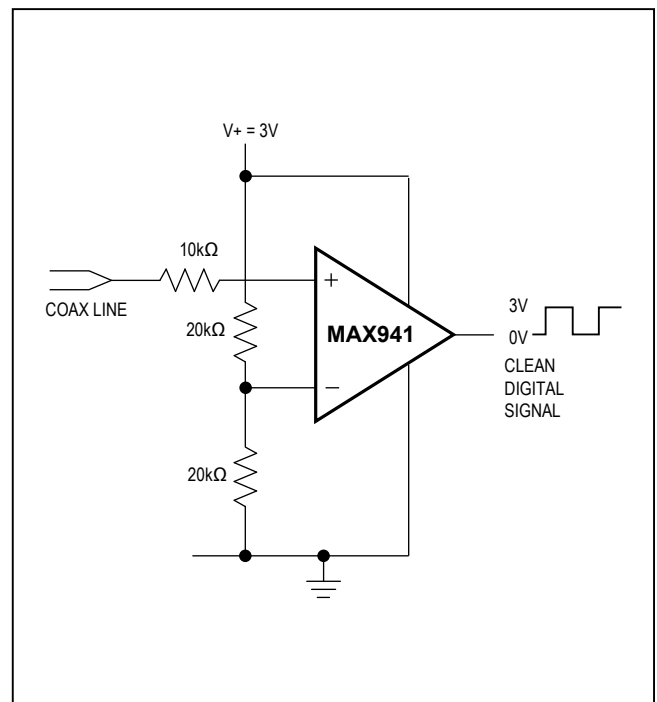

Figure 6. Line Transceiver Application

MAX941/MAX942/
MAX944

High-Speed, Low-Power, 3V/5V, Rail-to-Rail,
Single-Supply Comparators

Ordering Information (continued)

PART	TEMP RANGE	PIN- PACKAGE
MAX942 MSA/PR	-55°C to +125°C	8 SO
MAX942CPA	0°C to +70°C	8 PDIP
MAX942CSA	0°C to +70°C	8 SO
MAX942EPA	-40°C to +85°C	8 PDIP
MAX942ESA	-40°C to +85°C	8 SO
MAX942EUA-T	-40°C to +85°C	8 μ MAX
MAX942AUA-T	-40°C to +125°C	8 μ MAX
MAX944 CPD	0°C to +70°C	14 PDIP
MAX944CSD	0°C to +70°C	14 SO
MAX944EPD	-40°C to +85°C	14 PDIP
MAX944ESD	-40°C to +85°C	14 SO

T = Tape and reel.

Chip Information

PROCESS: BIPOLAR

Package Information

For the latest package outline information and land patterns (footprints), go to www.maximintegrated.com/packages. Note that a "+", "#", or "-" in the package code indicates RoHS status only. Package drawings may show a different suffix character, but the drawing pertains to the package regardless of RoHS status.

PACKAGE TYPE	PACKAGE CODE	OUTLINE NO.	LAND PATTERN NO.
8 μ MAX	U8-1	21-0036	90-0092
8 PDIP	P8-1	21-0043	—
8 SO	S8-2	21-0041	90-0096
14 PDIP	P14-3	21-0043	—
14 SO	S14-1	21-0041	90-0112

Revision History

REVISION NUMBER	REVISION DATE	DESCRIPTION	PAGES CHANGED
8	12/08	Added SO package diagram and removed transistor count	10
9	3/09	Corrected <i>Ordering Information</i> for MAX944ESD	10
10	9/14	Corrected <i>Electrical Characteristics</i> and removed automotive reference from Features	1, 3

For pricing, delivery, and ordering information, please contact Maxim Direct at 1-888-629-4642, or visit Maxim Integrated's website at www.maximintegrated.com.

Maxim Integrated cannot assume responsibility for use of any circuitry other than circuitry entirely embodied in a Maxim Integrated product. No circuit patent licenses are implied. Maxim Integrated reserves the right to change the circuitry and specifications without notice at any time. The parametric values (min and max limits) shown in the Electrical Characteristics table are guaranteed. Other parametric values quoted in this data sheet are provided for guidance.

Mouser Electronics

Authorized Distributor

Click to View Pricing, Inventory, Delivery & Lifecycle Information:

Maxim Integrated:

[MAX941CSA+](#) [MAX941ESA+](#) [MAX942CPA+](#) [MAX942CSA+](#) [MAX942EPA+](#) [MAX942ESA+](#) [MAX942EUA+](#)
[MAX944CSD+](#) [MAX944ESD+](#) [MAX941CPA](#) [MAX941CPA+](#) [MAX941CSA](#) [MAX941CSA+T](#) [MAX941EPA+](#)
[MAX941ESA+T](#) [MAX941EUA](#) [MAX941EUA+](#) [MAX941EUA+T](#) [MAX941EUA-T](#) [MAX942AUA+](#) [MAX942AUA+T](#)
[MAX942CSA](#) [MAX942CSA+T](#) [MAX942MSA/PR](#) [MAX942MSA/PR-T](#) [MAX942CUA+](#) [MAX942CUA+T](#) [MAX942ESA](#)
[MAX942ESA+T](#) [MAX942ESA-T](#) [MAX942EUA+T](#) [MAX944CPD+](#) [MAX944CSD](#) [MAX944CSD+T](#) [MAX944EPD+](#)
[MAX944ESD+T](#) [MAX941CSA-T](#) [MAX941ESA](#) [MAX941ESA-T](#) [MAX942CSA-T](#) [MAX942EPA](#) [MAX944CPD](#)
[MAX944CSD-T](#) [MAX944EPD](#) [MAX944ESD](#) [MAX944ESD-T](#)