

IRG4PH50UD

INSULATED GATE BIPOLAR TRANSISTOR WITH ULTRAFAST SOFT RECOVERY DIODE UltraFast CoPack IGBT

Features

- UltraFast: Optimized for high operating frequencies up to 40 kHz in hard switching, >200 kHz in resonant mode
- New IGBT design provides tighter parameter distribution and higher efficiency than previous generations
- IGBT co-packaged with HEXFRED™ ultrafast, ultra-soft-recovery anti-parallel diodes for use in bridge configurations
- Industry standard TO-247AC package

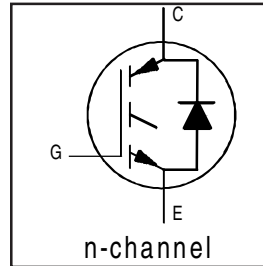

$V_{CES} = 1200V$
$V_{CE(on)} \text{ typ.} = 2.78V$
@ $V_{GE} = 15V, I_C = 24A$

Benefits

- Higher switching frequency capability than competitive IGBTs
- Highest efficiency available
- HEXFRED diodes optimized for performance with IGBT's. Minimized recovery characteristics require less/no snubbing

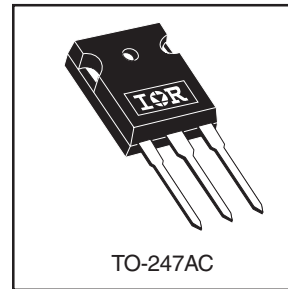

Absolute Maximum Ratings

	Parameter	Max.	Units
V_{CES}	Collector-to-Emitter Breakdown Voltage	1200	V
$I_C @ T_C = 25^\circ C$	Continuous Collector Current	45	A
$I_C @ T_C = 100^\circ C$	Continuous Collector Current	24	
I_{CM}	Pulsed Collector Current ①	180	
I_{LM}	Clamped Inductive Load Current ②	180	
$I_F @ T_C = 100^\circ C$	Diode Continuous Forward Current	16	
I_{FM}	Diode Maximum Forward Current	180	
V_{GE}	Gate-to-Emitter Voltage	± 20	V
$P_D @ T_C = 25^\circ C$	Maximum Power Dissipation	200	W
$P_D @ T_C = 100^\circ C$	Maximum Power Dissipation	78	
T_J	Operating Junction and Storage Temperature Range	-55 to + 150	$^\circ C$
T_{STG}			
	Mounting torque, 6-32 or M3 screw.	10 lbf•in (1.1N•m)	

Thermal Resistance

	Parameter	Min.	Typ.	Max.	Units
$R_{\theta JC}$	Junction-to-Case - IGBT	—	—	0.64	$^\circ C/W$
$R_{\theta JC}$	Junction-to-Case - Diode	—	—	0.83	
$R_{\theta CS}$	Case-to-Sink, flat, greased surface	—	0.24	—	
$R_{\theta JA}$	Junction-to-Ambient, typical socket mount	—	—	40	
W_t	Weight	—	6 (0.21)	—	g (oz)

Electrical Characteristics @ T_J = 25°C (unless otherwise specified)

	Parameter	Min.	Typ.	Max.	Units	Conditions
V _{(BR)CES}	Collector-to-Emitter Breakdown Voltage ^③	1200	—	—	V	V _{GE} = 0V, I _C = 250μA
ΔV _{(BR)CES/ΔT_J}	Temperature Coeff. of Breakdown Voltage	—	1.20	—	V/°C	V _{GE} = 0V, I _C = 1.0mA
V _{CE(on)}	Collector-to-Emitter Saturation Voltage	—	2.56	3.5	V	I _C = 20A V _{GE} = 15V
		—	2.78	3.7		I _C = 24A
		—	3.20	—		I _C = 45A See Fig. 2, 5
		—	2.54	—		I _C = 24A, T _J = 150°C
V _{GE(th)}	Gate Threshold Voltage	3.0	—	6.0		V _{CE} = V _{GE} , I _C = 250μA
ΔV _{GE(th)/ΔT_J}	Temperature Coeff. of Threshold Voltage	—	-13	—	mV/°C	V _{CE} = V _{GE} , I _C = 250μA
g _{fe}	Forward Transconductance ^④	23	35	—	S	V _{CE} = 100V, I _C = 24A
I _{CES}	Zero Gate Voltage Collector Current	—	—	250	μA	V _{GE} = 0V, V _{CE} = 1200V
		—	—	6500		V _{GE} = 0V, V _{CE} = 1200V, T _J = 150°C
V _{FM}	Diode Forward Voltage Drop	—	2.5	3.5	V	I _C = 16A See Fig. 13
		—	2.1	3.0		I _C = 16A, T _J = 150°C
I _{GES}	Gate-to-Emitter Leakage Current	—	—	±100	nA	V _{GE} = ±20V

Switching Characteristics @ T_J = 25°C (unless otherwise specified)

	Parameter	Min.	Typ.	Max.	Units	Conditions
Q _g	Total Gate Charge (turn-on)	—	160	250	nC	I _C = 24A V _{CC} = 400V See Fig. 8 V _{GE} = 15V
Q _{ge}	Gate - Emitter Charge (turn-on)	—	27	40		
Q _{gc}	Gate - Collector Charge (turn-on)	—	53	80		
t _{d(on)}	Turn-On Delay Time	—	47	—	ns	T _J = 25°C I _C = 24A, V _{CC} = 800V V _{GE} = 15V, R _G = 5.0Ω Energy losses include "tail" and diode reverse recovery. See Fig. 9, 10, 18
t _r	Rise Time	—	24	—		
t _{d(off)}	Turn-Off Delay Time	—	110	170		
t _f	Fall Time	—	180	260		
E _{on}	Turn-On Switching Loss	—	2.10	—	mJ	See Fig. 9, 10, 18
E _{off}	Turn-Off Switching Loss	—	1.50	—		
E _{ts}	Total Switching Loss	—	3.60	4.6		
t _{d(on)}	Turn-On Delay Time	—	46	—	ns	T _J = 150°C, See Fig. 11, 18 I _C = 24A, V _{CC} = 800V V _{GE} = 15V, R _G = 5.0Ω Energy losses include "tail" and diode reverse recovery.
t _r	Rise Time	—	27	—		
t _{d(off)}	Turn-Off Delay Time	—	240	—		
t _f	Fall Time	—	330	—		
E _{ts}	Total Switching Loss	—	6.38	—	mJ	Measured 5mm from package
L _E	Internal Emitter Inductance	—	13	—	nH	
C _{ies}	Input Capacitance	—	3600	—	pF	V _{GE} = 0V V _{CC} = 30V See Fig. 7 f = 1.0MHz
C _{oes}	Output Capacitance	—	160	—		
C _{res}	Reverse Transfer Capacitance	—	31	—		
t _{rr}	Diode Reverse Recovery Time	—	90	135	ns	T _J = 25°C See Fig. 14
		—	164	245		T _J = 125°C
I _{rr}	Diode Peak Reverse Recovery Current	—	5.8	10	A	T _J = 25°C See Fig. 15
		—	8.3	15		T _J = 125°C
Q _{rr}	Diode Reverse Recovery Charge	—	260	675	nC	T _J = 25°C See Fig. 16
		—	680	1838		T _J = 125°C
di _{(rec)M/dt}	Diode Peak Rate of Fall of Recovery During t _b	—	120	—	A/μs	T _J = 25°C See Fig. 17
		—	76	—		T _J = 125°C

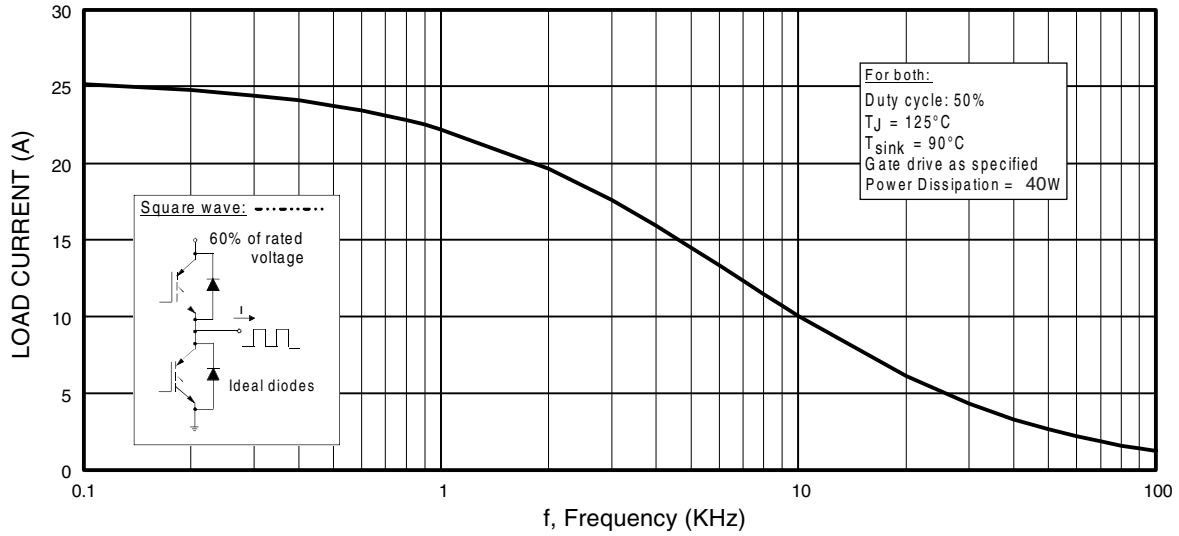

Fig. 1 - Typical Load Current vs. Frequency
 (Load Current = I_{RMS} of fundamental)

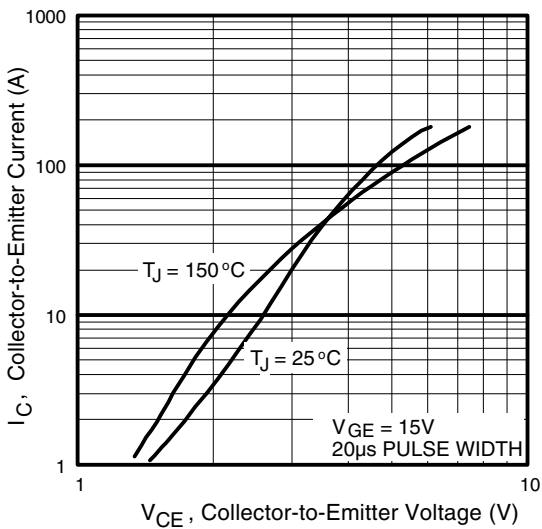

Fig. 2 - Typical Output Characteristics
www.irf.com

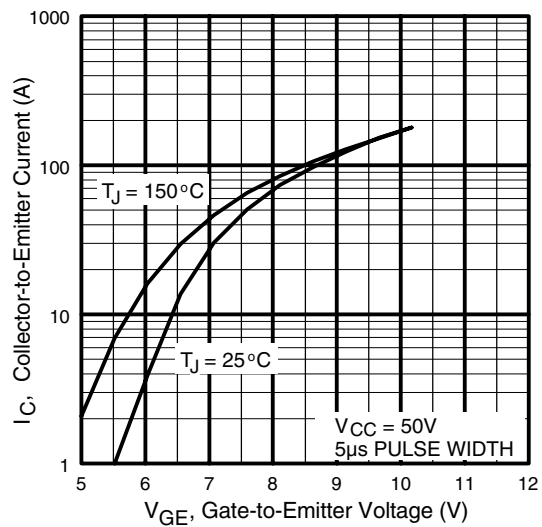

Fig. 3 - Typical Transfer Characteristics

IRG4PH50UD

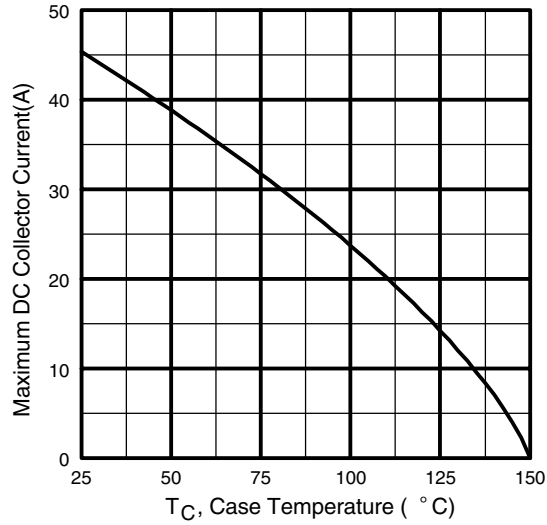

Fig. 4 - Maximum Collector Current vs. Case Temperature

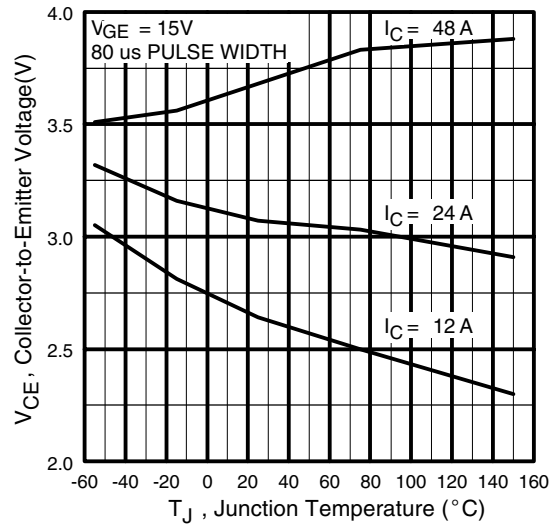

Fig. 5 - Typical Collector-to-Emitter Voltage vs. Junction Temperature

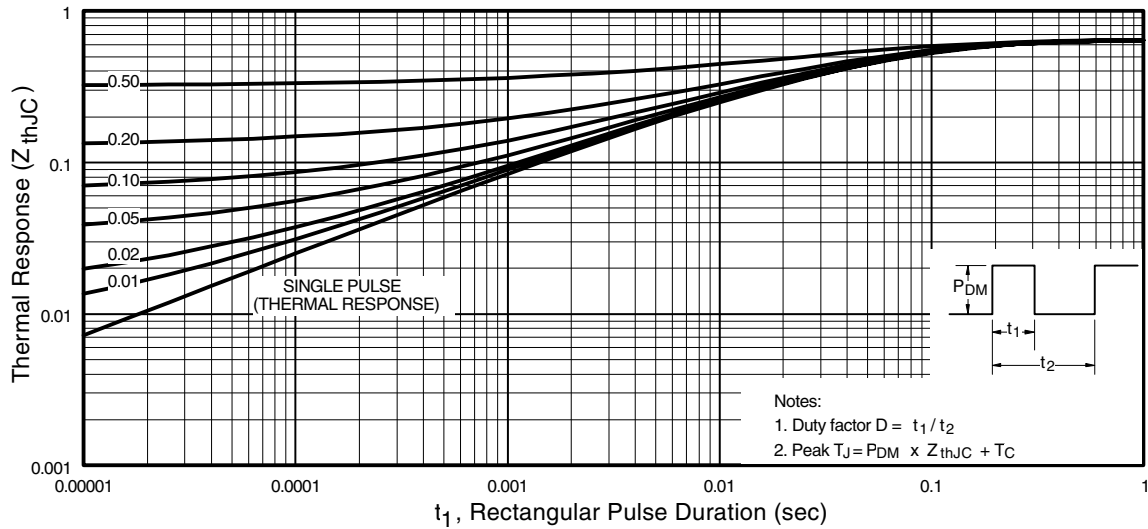

Fig. 6 - Maximum Effective Transient Thermal Impedance, Junction-to-Case

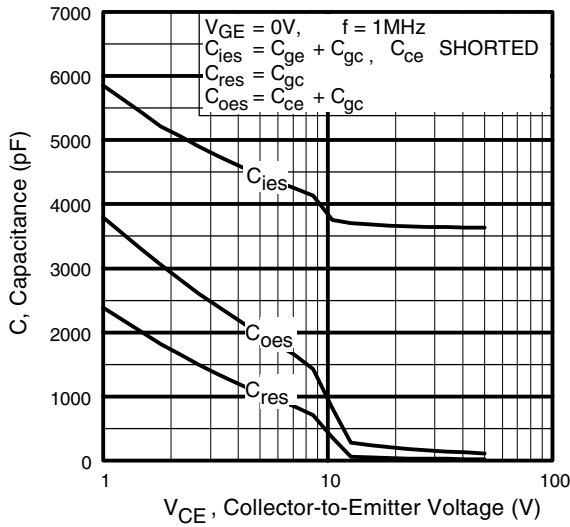

Fig. 7 - Typical Capacitance vs. Collector-to-Emitter Voltage

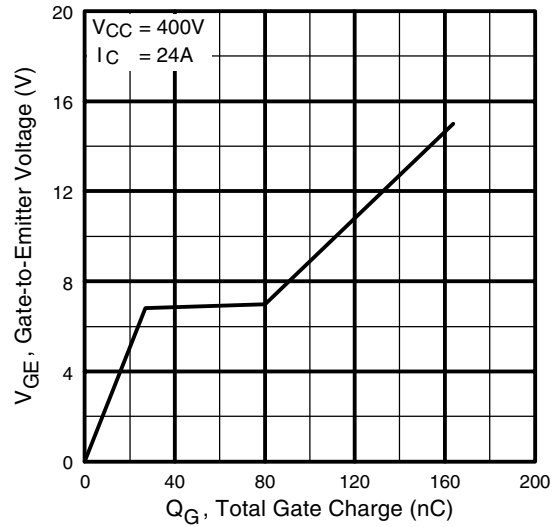

Fig. 8 - Typical Gate Charge vs. Gate-to-Emitter Voltage

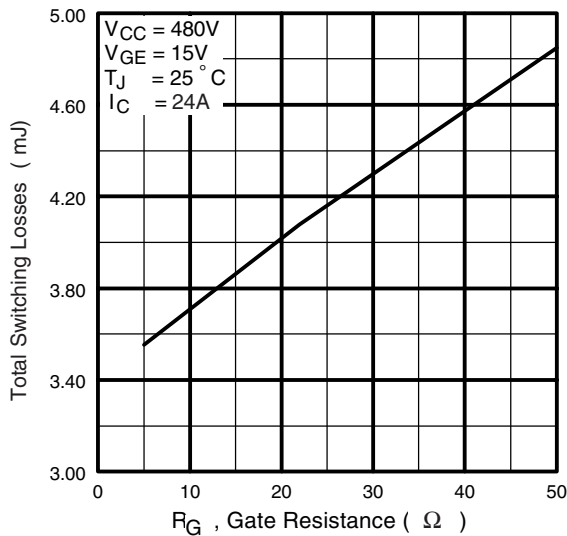

Fig. 9 - Typical Switching Losses vs. Gate Resistance

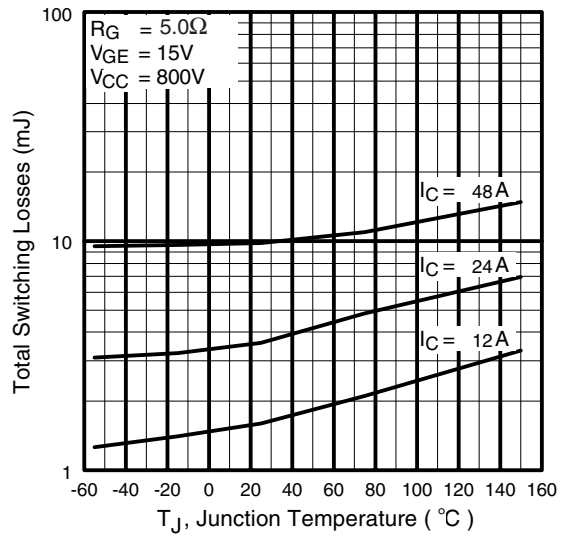

Fig. 10 - Typical Switching Losses vs. Junction Temperature

IRG4PH50UD

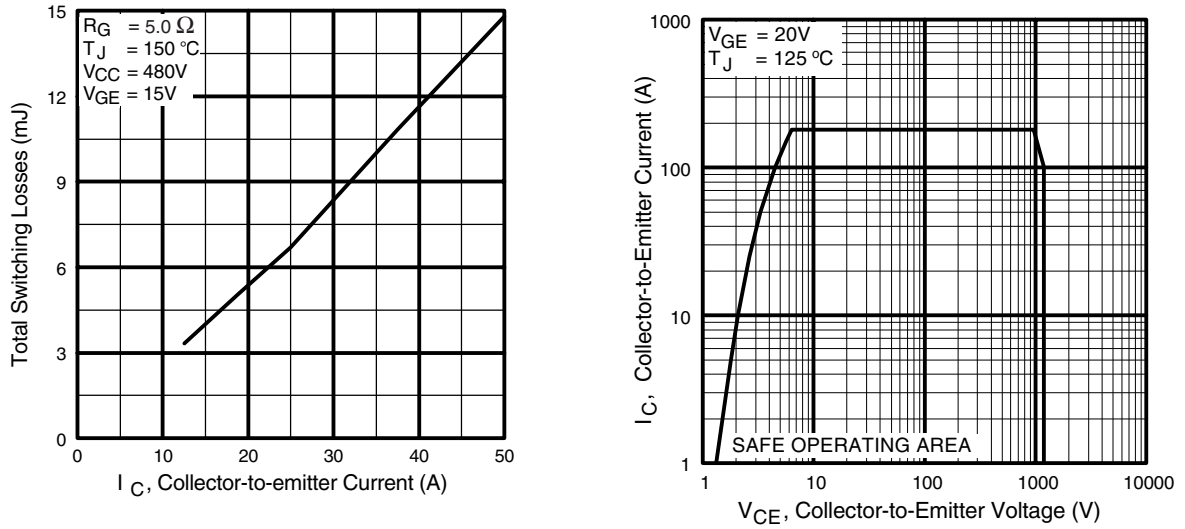

Fig. 11 - Typical Switching Losses vs. Collector-to-Emitter Current

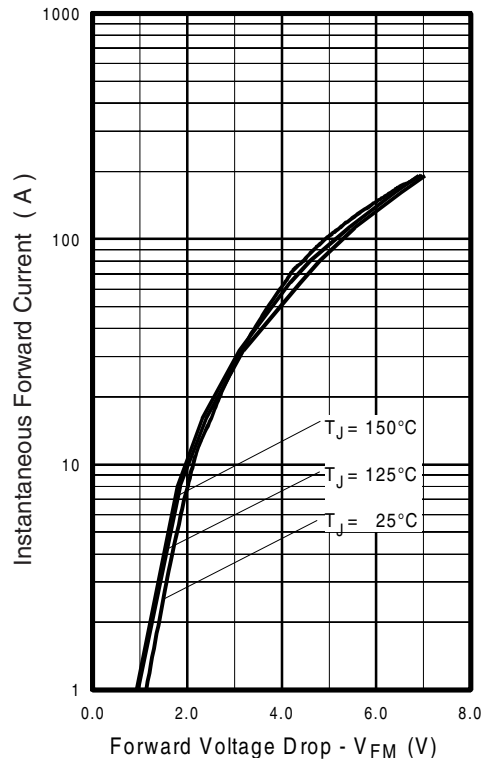

Fig. 13 - Typical Forward Voltage Drop vs. Instantaneous Forward Current

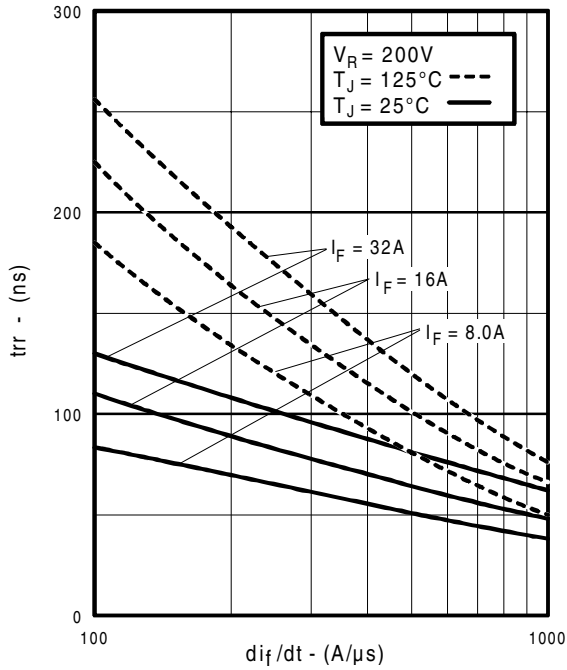

Fig. 14 - Typical Reverse Recovery vs. di_f/dt

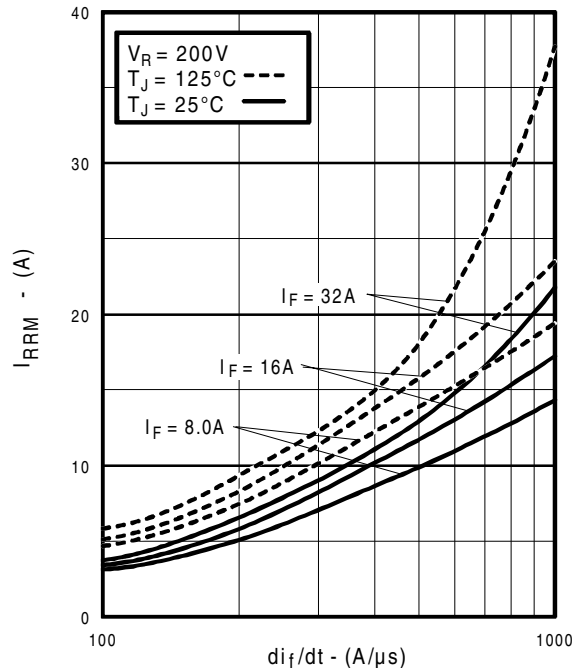

Fig. 15 - Typical Recovery Current vs. di_f/dt

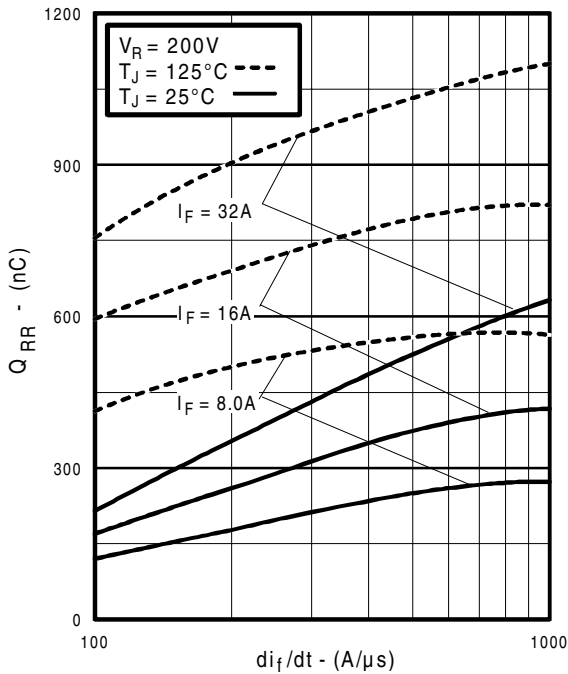

Fig. 16 - Typical Stored Charge vs. di_f/dt

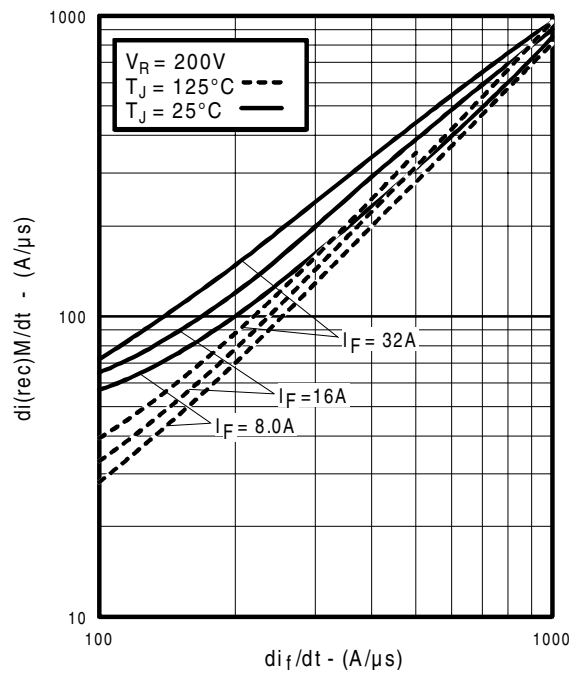

Fig. 17 - Typical $di_{(rec)M}/dt$ vs. di_f/dt

IRG4PH50UD

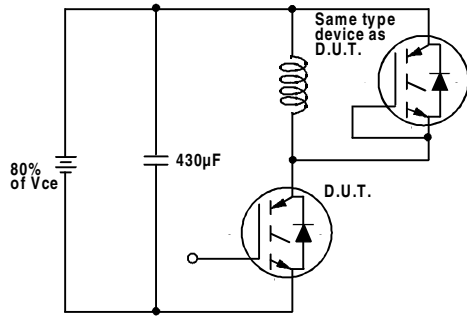

Fig. 18a - Test Circuit for Measurement of I_{LM} , E_{on} , $E_{off}(\text{diode})$, t_{rr} , Q_{rr} , I_{rr} , $t_{d(on)}$, t_r , $t_{d(off)}$, t_f

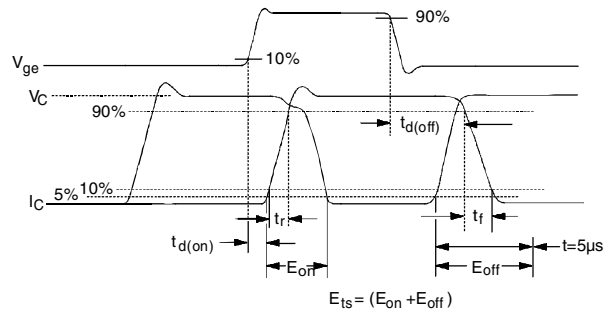

Fig. 18b - Test Waveforms for Circuit of Fig. 18a, Defining E_{off} , $t_{d(off)}$, t_f

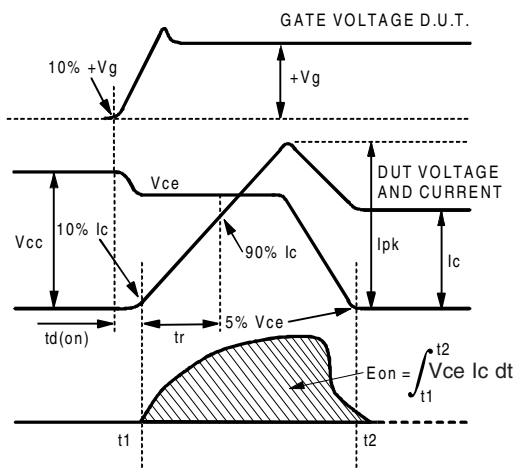

Fig. 18c - Test Waveforms for Circuit of Fig. 18a, Defining E_{on} , $t_{d(on)}$, t_r

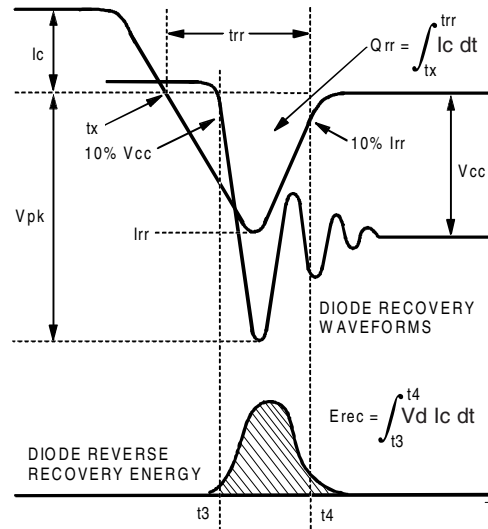

Fig. 18d - Test Waveforms for Circuit of Fig. 18a, Defining E_{rec} , t_{rr} , Q_{rr} , I_{rr}

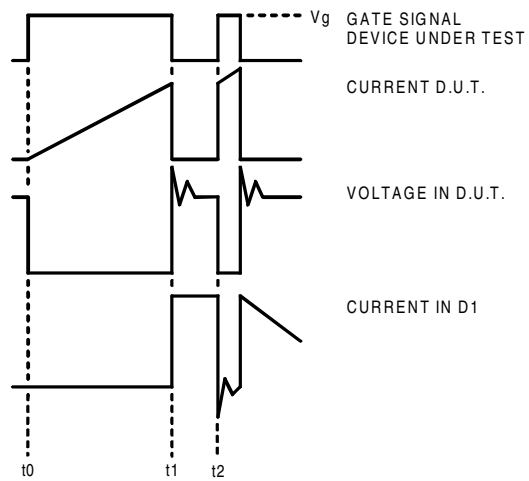

Figure 18e. Macro Waveforms for Figure 18a's Test Circuit

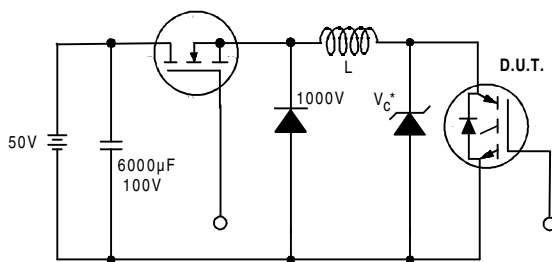

Figure 19. Clamped Inductive Load Test Circuit

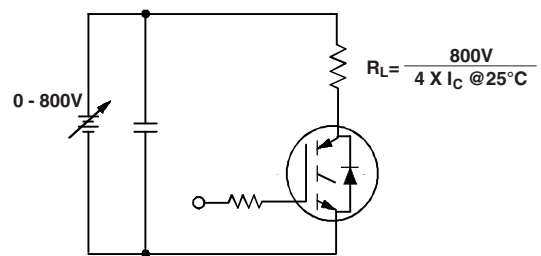

Figure 20. Pulsed Collector Current Test Circuit

IRG4PH50UD

International
IR Rectifier

Notes:

- ① Repetitive rating: $V_{GE}=20V$; pulse width limited by maximum junction temperature (figure 20)
- ② $V_{CC}=80\%(V_{CES})$, $V_{GE}=20V$, $L=10\mu H$, $R_G=5.0\Omega$ (figure 19)
- ③ Pulse width $\leq 80\mu s$; duty factor $\leq 0.1\%$.
- ④ Pulse width $5.0\mu s$, single shot.

Case Outline — TO-247AC

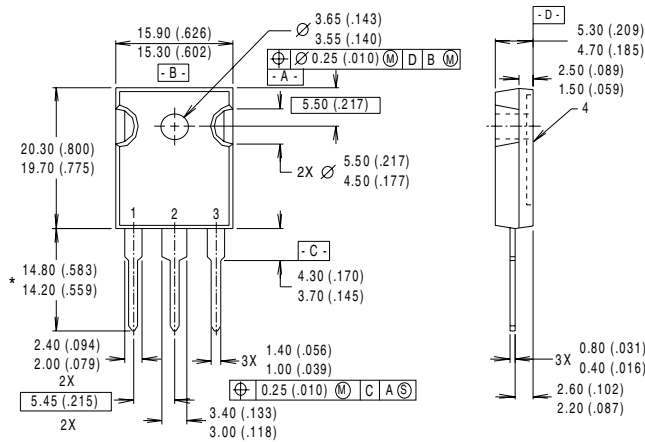

NOTES:

- 1 DIMENSIONS & TOLERANCING PER ANSI Y14.5M, 1982.
- 2 CONTROLLING DIMENSION : INCH.
- 3 DIMENSIONS ARE SHOWN MILLIMETERS (INCHES).
- 4 CONFORMS TO JEDEC OUTLINE TO-247AC.

LEAD ASSIGNMENTS

- 1 - GATE
- 2 - COLLECTOR
- 3 - EMITTER
- 4 - COLLECTOR

* LONGER LEADED (20mm) VERSION AVAILABLE (TO-247AD) TO ORDER ADD *-E* SUFFIX TO PART NUMBER

CONFORMS TO JEDEC OUTLINE TO-247AC (TO-3P)

Dimensions in Millimeters and (Inches)

International
IR Rectifier

IR WORLD HEADQUARTERS: 233 Kansas St., El Segundo, California 90245, USA Tel: (310) 252-7105

IR EUROPEAN REGIONAL CENTRE: 439/445 Godstone Rd, Whyteleafe, Surrey CR3 OBL, UK Tel: ++ 44 (0)20 8645 8000

IR CANADA: 15 Lincoln Court, Brampton, Ontario L6T3Z2, Tel: (905) 453 2200

IR GERMANY: Saalburgstrasse 157, 61350 Bad Homburg Tel: ++ 49 (0) 6172 96590

IR ITALY: Via Liguria 49, 10071 Borgaro, Torino Tel: ++ 39 011 451 0111

IR JAPAN: K&H Bldg., 2F, 30-4 Nishi-Ikebukuro 3-Chome, Toshima-Ku, Tokyo 171 Tel: 81 (0)3 3983 0086

IR SOUTHEAST ASIA: 1 Kim Seng Promenade, Great World City West Tower, 13-11, Singapore 237994 Tel: ++ 65 (0)838 4630

IR TAIWAN: 16 Fl. Suite D. 207, Sec. 2, Tun Haw South Road, Taipei, 10673 Tel: 886-(0)2 2377 9936

Data and specifications subject to change without notice. 7/00

Note: For the most current drawings please refer to the IR website at:
<http://www.irf.com/package/>