

**± 2% NEGATIVE VOLTAGE REGULATORS**

- OUTPUT CURRENT UP TO 1.5A
- OUTPUT VOLTAGES OF -5; -5.2; -6; -8; -12; -15; -18; -20; -22; -24V
- THERMAL CIRCUIT PROTECTION
- OUTPUT TRANSISTOR SOA PROTECTION

**DESCRIPTION**

The L7900A series of three-terminal negative regulators is available in TO-220 package and with several output voltage. They can provide local on-card regulation, eliminating the distribution problems associated with single point regulation; furthermore, having the same voltage options as the L7800 positive standard series, they are particularly suited for split power supplies. In addition, the -5.2V is also available for ECL system.

If adequate heatsinking is provided, the L7900A series can deliver an output current in excess of 1.5A. Although designed primarily as fixed voltage regulators, these devices can be used with external components to obtain adjustable voltages and currents.

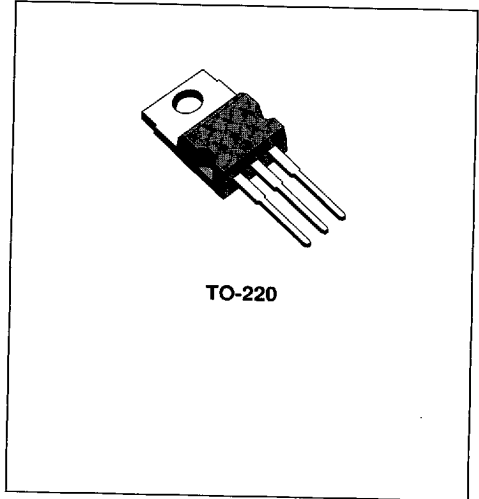

**SCHEMATIC DIAGRAM**

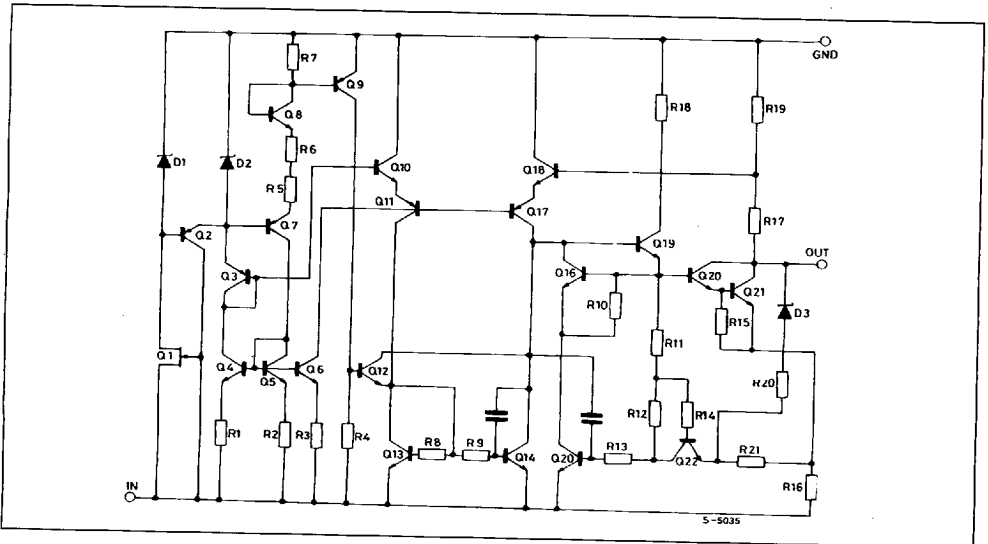

# L7900AB/AC SERIES

## ABSOLUTE MAXIMUM RATING

Symbol	Parameter	Value	Unit
$V_i$	DC Input Voltage (for $V_o = -5$ to $-18$ V) (for $V_o = -20, -24$ )	-35	V
		-40	V
$I_o$	Output Current	Internally Limited	
$P_{tot}$	Total Power Dissipation	Internally Limited	
$T_{op}$	Operating Junction Temperature for L7900AC for L7900AB	0 to 125 -40 to 125	°C
$T_{stg}$	Storage Temperature	-65 to 150	°C

## THERMAL DATA

Symbol	Parameter	Max	Value	Unit
$R_{th(j-case)}$	Thermal Resistance Junction-Case	Max	3	°C/W
$R_{th(j-amb)}$	Thermal Resistance Junction-Ambient	Max	50	°C/W

## CONNECTION DIAGRAM AND ORDERING NUMBERS (top views)

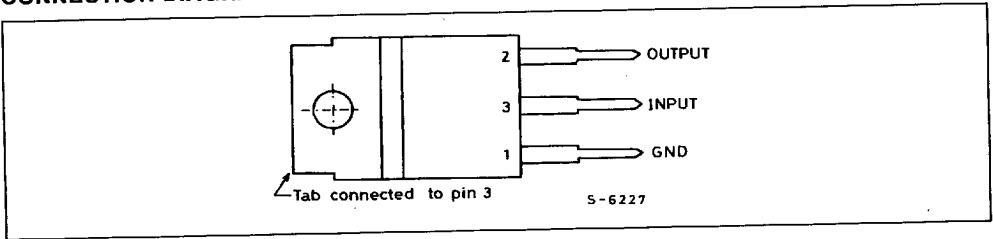

TYPE	TO-220	TO-220	OUTPUT VOLTAGE
	$T_j = -40$ to $125$ °C	$T_j = 0$ to $125$ °C	
L7905A	L7905ABV	L7905ACV	-5 V
L7952A	L7952ABV	L7952ACV	-5.2 V
L7906A	L7906ABV	L7906ACV	-6 V
L7908A	L7908ABV	L7908ACV	-8 V
L7912A	L7912ABV	L7912ACV	-12 V
L7915A	L7915ABV	L7915ACV	-15 V
L7818A	L7818ABV	L7818ACV	-18 V
L7920A	L7920ABV	L7920ACV	-20 V
L7922A	L7922ABV	L7922ACV	-22 V
L7924A	L7924ABV	L7924ACV	-24 V

## APPLICATION CIRCUIT

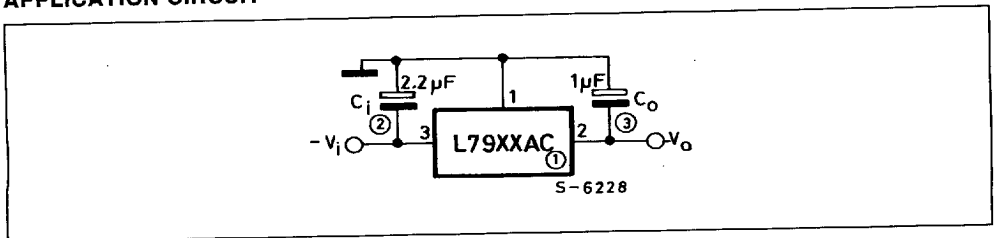

**ELECTRICAL CHARACTERISTICS FOR L7905A** (refer to the test circuits,  $T_j = 0$  to  $125\text{ }^\circ\text{C}$ ,  $V_i = -10\text{V}$ ,  $I_o = 500\text{ mA}$ ,  $C_i = 2.2\text{ }\mu\text{F}$ ,  $C_o = 1\text{ }\mu\text{F}$  unless otherwise specified)

Symbol	Parameter	Test Conditions	Min.	Typ.	Max.	Unit
$V_o$	Output Voltage	$T_j = 25\text{ }^\circ\text{C}$	-4.9	-5	-5.1	V
$V_o$	Output Voltage	$I_o = -5\text{ mA to } -1\text{ A}$ $P_o \leq 15\text{ W}$ $V_i = -8\text{ to } -20\text{ V}$	-4.8	-5	-5.2	V
$\Delta V_o^*$	Line Regulation	$V_i = -7\text{ to } -25\text{ V}$ $T_j = 25\text{ }^\circ\text{C}$ $V_i = -8\text{ to } -12\text{ V}$ $T_j = 25\text{ }^\circ\text{C}$			100 50	mV mV
$\Delta V_o^*$	Load Regulation	$I_o = 5\text{ to } 1500\text{ mA}$ $T_j = 25\text{ }^\circ\text{C}$ $I_o = 250\text{ to } 750\text{ mA}$ $T_j = 25\text{ }^\circ\text{C}$			100 50	mV mV
$I_d$	Quiescent Current	$T_j = 25\text{ }^\circ\text{C}$			3	mA
$\Delta I_d$	Quiescent Current Change	$I_o = 5\text{ to } 1000\text{ mA}$			0.5	mA
$\Delta I_d$	Quiescent Current Change	$V_i = -8\text{ to } -25\text{ V}$			1.3	mA
$\frac{\Delta V_o}{\Delta T}$	Output Voltage Drift	$I_o = 5\text{ mA}$		-0.4		mV/°C
$e_N$	Output Noise Voltage	$B = 10\text{Hz to } 100\text{KHz}$ $T_j = 25\text{ }^\circ\text{C}$		100		$\mu\text{V}$
SVR	Supply Voltage Rejection	$\Delta V_i = 10\text{ V}$ $f = 120\text{ Hz}$	54	60		dB
$V_d$	Dropout Voltage	$I_o = 1\text{ A}$ $T_j = 25\text{ }^\circ\text{C}$ $\Delta V_o = 100\text{ mV}$		1.4		V
$I_{sc}$	Short Circuit Current			2.1		A
$I_{scp}$	Short Circuit Peak Current	$T_j = 25\text{ }^\circ\text{C}$		2.5		A

**ELECTRICAL CHARACTERISTICS FOR L7952A** (refer to the test circuits,  $T_j = 0$  to  $125\text{ }^\circ\text{C}$ ,  $V_i = -10\text{V}$ ,  $I_o = 500\text{ mA}$ ,  $C_i = 2.2\text{ }\mu\text{F}$ ,  $C_o = 1\text{ }\mu\text{F}$  unless otherwise specified)

Symbol	Parameter	Test Conditions	Min.	Typ.	Max.	Unit
$V_o$	Output Voltage	$T_j = 25\text{ }^\circ\text{C}$	-5.1	-5.2	-5.3	V
$V_o$	Output Voltage	$I_o = -5\text{ mA to } -1\text{ A}$ $P_o \leq 15\text{ W}$ $V_i = -9\text{ to } -21\text{ V}$	-5	-5.2	-5.4	V
$\Delta V_o^*$	Line Regulation	$V_i = -8\text{ to } -25\text{ V}$ $T_j = 25\text{ }^\circ\text{C}$ $V_i = -9\text{ to } -13\text{ V}$ $T_j = 25\text{ }^\circ\text{C}$			105 52	mV mV
$\Delta V_o^*$	Load Regulation	$I_o = 5\text{ to } 1500\text{ mA}$ $T_j = 25\text{ }^\circ\text{C}$ $I_o = 250\text{ to } 750\text{ mA}$ $T_j = 25\text{ }^\circ\text{C}$			105 52	mV mV
$I_d$	Quiescent Current	$T_j = 25\text{ }^\circ\text{C}$			3	mA
$\Delta I_d$	Quiescent Current Change	$I_o = 5\text{ to } 1000\text{ mA}$			0.5	mA
$\Delta I_d$	Quiescent Current Change	$V_i = -9\text{ to } -25\text{ V}$			1.3	mA
$\frac{\Delta V_o}{\Delta T}$	Output Voltage Drift	$I_o = 5\text{ mA}$		-0.5		mV/°C
$e_N$	Output Noise Voltage	$B = 10\text{Hz to } 100\text{KHz}$ $T_j = 25\text{ }^\circ\text{C}$		125		$\mu\text{V}$
SVR	Supply Voltage Rejection	$\Delta V_i = 10\text{ V}$ $f = 120\text{ Hz}$	54	60		dB
$V_d$	Dropout Voltage	$I_o = 1\text{ A}$ $T_j = 25\text{ }^\circ\text{C}$ $\Delta V_o = 100\text{ mV}$		1.4		V
$I_{sc}$	Short Circuit Current			2.1		A
$I_{scp}$	Short Circuit Peak Current	$T_j = 25\text{ }^\circ\text{C}$		2.5		A

\* Load and line regulation are specified at constant junction temperature. Changes in  $V_o$  due to heating effects must be taken into account separately. Pulse testing with low duty cycle is used.

**L7900AB/AC SERIES**

**ELECTRICAL CHARACTERISTICS FOR L7906A** (refer to the test circuits,  $T_j = 0$  to  $125^\circ\text{C}$ ,  
 $V_i = -11\text{V}$ ,  $I_o = 500\text{ mA}$ ,  $C_i = 2.2\ \mu\text{F}$ ,  $C_o = 1\ \mu\text{F}$  unless otherwise specified)

Symbol	Parameter	Test Conditions	Min.	Typ.	Max.	Unit
$V_o$	Output Voltage	$T_j = 25^\circ\text{C}$	-5.88	-6	-6.12	V
$V_o$	Output Voltage	$I_o = -5\text{ mA to } -1\text{ A}$ $P_o \leq 15\text{ W}$ $V_i = -9.5\text{ to } -21.5\text{ V}$	-5.76	-6	-6.24	V
$\Delta V_o^*$	Line Regulation	$V_i = -8.5\text{ to } -25\text{ V}$ $T_j = 25^\circ\text{C}$ $V_i = -9\text{ to } -15\text{ V}$ $T_j = 25^\circ\text{C}$			120 60	mV mV
$\Delta V_o^*$	Load Regulation	$I_o = 5\text{ to } 1500\text{ mA}$ $T_j = 25^\circ\text{C}$ $I_o = 250\text{ to } 750\text{ mA}$ $T_j = 25^\circ\text{C}$			120 60	mV mV
$I_d$	Quiescent Current	$T_j = 25^\circ\text{C}$			3	mA
$\Delta I_d$	Quiescent Current Change	$I_o = 5\text{ to } 1000\text{ mA}$			0.5	mA
$\Delta I_d$	Quiescent Current Change	$V_i = -9.5\text{ to } -25\text{ V}$			1.3	mA
$\frac{\Delta V_o}{\Delta T}$	Output Voltage Drift	$I_o = 5\text{ mA}$		-0.6		mV/ $^\circ\text{C}$
$e_N$	Output Noise Voltage	$B = 10\text{Hz to } 100\text{KHz}$ $T_j = 25^\circ\text{C}$		144		$\mu\text{V}$
SVR	Supply Voltage Rejection	$\Delta V_i = 10\text{ V}$ $f = 120\text{ Hz}$	54	60		dB
$V_d$	Dropout Voltage	$I_o = 1\text{ A}$ $T_j = 25^\circ\text{C}$ $\Delta V_o = 100\text{ mV}$		1.4		V
$I_{sc}$	Short Circuit Current			2		A
$I_{scp}$	Short Circuit Peak Current	$T_j = 25^\circ\text{C}$		2.5		A

**ELECTRICAL CHARACTERISTICS FOR L7908A** (refer to the test circuits,  $T_j = 0$  to  $125^\circ\text{C}$ ,  
 $V_i = -14\text{V}$ ,  $I_o = 500\text{ mA}$ ,  $C_i = 2.2\ \mu\text{F}$ ,  $C_o = 1\ \mu\text{F}$  unless otherwise specified)

Symbol	Parameter	Test Conditions	Min.	Typ.	Max.	Unit
$V_o$	Output Voltage	$T_j = 25^\circ\text{C}$	-5.1	-5.2	-5.3	V
$V_o$	Output Voltage	$I_o = -5\text{ mA to } -1\text{ A}$ $P_o \leq 15\text{ W}$ $V_i = -11.5\text{ to } -23\text{ V}$	-5	-5.2	-5.4	V
$\Delta V_o^*$	Line Regulation	$V_i = -10.5\text{ to } -25\text{ V}$ $T_j = 25^\circ\text{C}$ $V_i = -11\text{ to } -17\text{ V}$ $T_j = 25^\circ\text{C}$			160 80	mV mV
$\Delta V_o^*$	Load Regulation	$I_o = 5\text{ to } 1500\text{ mA}$ $T_j = 25^\circ\text{C}$ $I_o = 250\text{ to } 750\text{ mA}$ $T_j = 25^\circ\text{C}$			160 80	mV mV
$I_d$	Quiescent Current	$T_j = 25^\circ\text{C}$			3	mA
$\Delta I_d$	Quiescent Current Change	$I_o = 5\text{ to } 1000\text{ mA}$			0.5	mA
$\Delta I_d$	Quiescent Current Change	$V_i = -11.5\text{ to } -25\text{ V}$			1	mA
$\frac{\Delta V_o}{\Delta T}$	Output Voltage Drift	$I_o = 5\text{ mA}$		-0.8		mV/ $^\circ\text{C}$
$e_N$	Output Noise Voltage	$B = 10\text{Hz to } 100\text{KHz}$ $T_j = 25^\circ\text{C}$		175		$\mu\text{V}$
SVR	Supply Voltage Rejection	$\Delta V_i = 10\text{ V}$ $f = 120\text{ Hz}$	54	60		dB
$V_d$	Dropout Voltage	$I_o = 1\text{ A}$ $T_j = 25^\circ\text{C}$ $\Delta V_o = 100\text{ mV}$		1.1		V
$I_{sc}$	Short Circuit Current			1.5		A
$I_{scp}$	Short Circuit Peak Current	$T_j = 25^\circ\text{C}$		2.5		A

\* Load and line regulation are specified at constant junction temperature. Changes in  $V_o$  due to heating effects must be taken into account separately. Pulse testing with low duty cycle is used.

**ELECTRICAL CHARACTERISTICS FOR L7912A** (refer to the test circuits,  $T_j = 0$  to  $125\text{ }^\circ\text{C}$ ,  
 $V_i = -19\text{V}$ ,  $I_o = 500\text{ mA}$ ,  $C_i = 2.2\text{ }\mu\text{F}$ ,  $C_o = 1\text{ }\mu\text{F}$  unless otherwise specified)

Symbol	Parameter	Test Conditions	Min.	Typ.	Max.	Unit
$V_o$	Output Voltage	$T_j = 25\text{ }^\circ\text{C}$	-11.75	-12	-12.75	V
$V_o$	Output Voltage	$I_o = -5\text{ mA to } -1\text{ A}$ $P_o \leq 15\text{ W}$ $V_i = -15.5\text{ to } -27\text{ V}$	-11.5	-12	-12.5	V
$\Delta V_o^*$	Line Regulation	$V_i = -14.5\text{ to } -30\text{ V}$ $T_j = 25\text{ }^\circ\text{C}$ $V_i = -16\text{ to } -22\text{ V}$ $T_j = 25\text{ }^\circ\text{C}$			240 120	mV mV
$\Delta V_o^*$	Load Regulation	$I_o = 5\text{ to } 1500\text{ mA}$ $T_j = 25\text{ }^\circ\text{C}$ $I_o = 250\text{ to } 750\text{ mA}$ $T_j = 25\text{ }^\circ\text{C}$			240 120	mV mV
$I_d$	Quiescent Current	$T_j = 25\text{ }^\circ\text{C}$			3	mA
$\Delta I_d$	Quiescent Current Change	$I_o = 5\text{ to } 1000\text{ mA}$			0.5	mA
$\Delta I_d$	Quiescent Current Change	$V_i = -15\text{ to } -25\text{ V}$			1	mA
$\frac{\Delta V_o}{\Delta T}$	Output Voltage Drift	$I_o = 5\text{ mA}$		-0.8		mV/ $^\circ\text{C}$
$e_N$	Output Noise Voltage	$B = 10\text{Hz to } 100\text{KHz}$ $T_j = 25\text{ }^\circ\text{C}$		200		$\mu\text{V}$
SVR	Supply Voltage Rejection	$\Delta V_i = 10\text{ V}$ $f = 120\text{ Hz}$	54	60		dB
$V_d$	Dropout Voltage	$I_o = 1\text{ A}$ $T_j = 25\text{ }^\circ\text{C}$ $\Delta V_o = 100\text{ mV}$		1.1		V
$I_{sc}$	Short Circuit Current			2.1		A
$I_{scp}$	Short Circuit Peak Current	$T_j = 25\text{ }^\circ\text{C}$		2.5		A

**ELECTRICAL CHARACTERISTICS FOR L7915A** (refer to the test circuits,  $T_j = 0$  to  $125\text{ }^\circ\text{C}$ ,  
 $V_i = -23\text{V}$ ,  $I_o = 500\text{ mA}$ ,  $C_i = 2.2\text{ }\mu\text{F}$ ,  $C_o = 1\text{ }\mu\text{F}$  unless otherwise specified)

Symbol	Parameter	Test Conditions	Min.	Typ.	Max.	Unit
$V_o$	Output Voltage	$T_j = 25\text{ }^\circ\text{C}$	-14.7	-15	-15.3	V
$V_o$	Output Voltage	$I_o = -5\text{ mA to } -1\text{ A}$ $P_o \leq 15\text{ W}$ $V_i = -18.5\text{ to } -30\text{ V}$	-14.4	-15	-15.6	V
$\Delta V_o^*$	Line Regulation	$V_i = -17.5\text{ to } -30\text{ V}$ $T_j = 25\text{ }^\circ\text{C}$ $V_i = -20\text{ to } -26\text{ V}$ $T_j = 25\text{ }^\circ\text{C}$			300 150	mV mV
$\Delta V_o^*$	Load Regulation	$I_o = 5\text{ to } 1500\text{ mA}$ $T_j = 25\text{ }^\circ\text{C}$ $I_o = 250\text{ to } 750\text{ mA}$ $T_j = 25\text{ }^\circ\text{C}$			300 150	mV mV
$I_d$	Quiescent Current	$T_j = 25\text{ }^\circ\text{C}$			3	mA
$\Delta I_d$	Quiescent Current Change	$I_o = 5\text{ to } 1000\text{ mA}$			0.5	mA
$\Delta I_d$	Quiescent Current Change	$V_i = -18.5\text{ to } -30\text{ V}$			1	mA
$\frac{\Delta V_o}{\Delta T}$	Output Voltage Drift	$I_o = 5\text{ mA}$		-0.9		mV/ $^\circ\text{C}$
$e_N$	Output Noise Voltage	$B = 10\text{Hz to } 100\text{KHz}$ $T_j = 25\text{ }^\circ\text{C}$		250		$\mu\text{V}$
SVR	Supply Voltage Rejection	$\Delta V_i = 10\text{ V}$ $f = 120\text{ Hz}$	54	60		dB
$V_d$	Dropout Voltage	$I_o = 1\text{ A}$ $T_j = 25\text{ }^\circ\text{C}$ $\Delta V_o = 100\text{ mV}$		1.1		V
$I_{sc}$	Short Circuit Current			1.3		A
$I_{scp}$	Short Circuit Peak Current	$T_j = 25\text{ }^\circ\text{C}$		2.2		A

\* Load and line regulation are specified at constant junction temperature. Changes in  $V_o$  due to heating effects must be taken into account separately. Pulse testing with low duty cycle is used.

7929237 0051480 941

## L7900AB/AC SERIES

**ELECTRICAL CHARACTERISTICS FOR L7918A** (refer to the test circuits,  $T_j = 0$  to  $125^\circ\text{C}$ ,  
 $V_i = -27\text{V}$ ,  $I_o = 500\text{ mA}$ ,  $C_i = 2.2\ \mu\text{F}$ ,  $C_o = 1\ \mu\text{F}$  unless otherwise specified)

Symbol	Parameter	Test Conditions	Min.	Typ.	Max.	Unit
$V_o$	Output Voltage	$T_j = 25^\circ\text{C}$	-17.64	-18	-18.36	V
$V_o$	Output Voltage	$I_o = -5\text{ mA to } -1\text{ A}$ $P_o \leq 15\text{ W}$ $V_i = -22\text{ to } -33\text{ V}$	-17.3	-18	-18.7	V
$\Delta V_o^*$	Line Regulation	$V_i = -21\text{ to } -33\text{ V}$ $T_j = 25^\circ\text{C}$ $V_i = -24\text{ to } -30\text{ V}$ $T_j = 25^\circ\text{C}$			360 180	mV mV
$\Delta V_o^*$	Load Regulation	$I_o = 5\text{ to } 1500\text{ mA}$ $T_j = 25^\circ\text{C}$ $I_o = 250\text{ to } 750\text{ mA}$ $T_j = 25^\circ\text{C}$			360 180	mV mV
$I_d$	Quiescent Current	$T_j = 25^\circ\text{C}$			3	mA
$\Delta I_d$	Quiescent Current Change	$I_o = 5\text{ to } 1000\text{ mA}$			0.5	mA
$\Delta I_d$	Quiescent Current Change	$V_i = -22\text{ to } -33\text{ V}$			1	mA
$\frac{\Delta V_o}{\Delta T}$	Output Voltage Drift	$I_o = 5\text{ mA}$		-1		mV/ $^\circ\text{C}$
$e_N$	Output Noise Voltage	$B = 10\text{Hz to } 100\text{KHz}$ $T_j = 25^\circ\text{C}$		300		$\mu\text{V}$
SVR	Supply Voltage Rejection	$\Delta V_i = 10\text{ V}$ $f = 120\text{ Hz}$	54	60		dB
$V_d$	Dropout Voltage	$I_o = 1\text{ A}$ $T_j = 25^\circ\text{C}$ $\Delta V_o = 100\text{ mV}$		1.1		V
$I_{sc}$	Short Circuit Current			1.1		A
$I_{scp}$	Short Circuit Peak Current	$T_j = 25^\circ\text{C}$		2.2		A

**ELECTRICAL CHARACTERISTICS FOR L7920A** (refer to the test circuits,  $T_j = 0$  to  $125^\circ\text{C}$ ,  
 $V_i = -29\text{V}$ ,  $I_o = 500\text{ mA}$ ,  $C_i = 2.2\ \mu\text{F}$ ,  $C_o = 1\ \mu\text{F}$  unless otherwise specified)

Symbol	Parameter	Test Conditions	Min.	Typ.	Max.	Unit
$V_o$	Output Voltage	$T_j = 25^\circ\text{C}$	-19.6	-20	-20.4	V
$V_o$	Output Voltage	$I_o = -5\text{ mA to } -1\text{ A}$ $P_o \leq 15\text{ W}$ $V_i = -24\text{ to } -35\text{ V}$	-19.2	-20	-20.8	V
$\Delta V_o^*$	Line Regulation	$V_i = -23\text{ to } -35\text{ V}$ $T_j = 25^\circ\text{C}$ $V_i = -26\text{ to } -32\text{ V}$ $T_j = 25^\circ\text{C}$			400 200	mV mV
$\Delta V_o^*$	Load Regulation	$I_o = 5\text{ to } 1500\text{ mA}$ $T_j = 25^\circ\text{C}$ $I_o = 250\text{ to } 750\text{ mA}$ $T_j = 25^\circ\text{C}$			400 200	mV mV
$I_d$	Quiescent Current	$T_j = 25^\circ\text{C}$			3	mA
$\Delta I_d$	Quiescent Current Change	$I_o = 5\text{ to } 1000\text{ mA}$			0.5	mA
$\Delta I_d$	Quiescent Current Change	$V_i = -24\text{ to } -35\text{ V}$			1	mA
$\frac{\Delta V_o}{\Delta T}$	Output Voltage Drift	$I_o = 5\text{ mA}$		-1.1		mV/ $^\circ\text{C}$
$e_N$	Output Noise Voltage	$B = 10\text{Hz to } 100\text{KHz}$ $T_j = 25^\circ\text{C}$		350		$\mu\text{V}$
SVR	Supply Voltage Rejection	$\Delta V_i = 10\text{ V}$ $f = 120\text{ Hz}$	54	60		dB
$V_d$	Dropout Voltage	$I_o = 1\text{ A}$ $T_j = 25^\circ\text{C}$ $\Delta V_o = 100\text{ mV}$		1.1		V
$I_{sc}$	Short Circuit Current			0.9		A
$I_{scp}$	Short Circuit Peak Current	$T_j = 25^\circ\text{C}$		2.2		A

\* Load and line regulation are specified at constant junction temperature. Changes in  $V_o$  due to heating effects must be taken into account separately. Pulse testing with low duty cycle is used.

**ELECTRICAL CHARACTERISTICS FOR L7922A** (refer to the test circuits,  $T_j = 0$  to  $125^\circ\text{C}$ ,  
 $V_i = -31\text{V}$ ,  $I_o = 500\text{ mA}$ ,  $C_i = 2.2\ \mu\text{F}$ ,  $C_o = 1\ \mu\text{F}$  unless otherwise specified)

Symbol	Parameter	Test Conditions	Min.	Typ.	Max.	Unit
$V_o$	Output Voltage	$T_j = 25^\circ\text{C}$	-21.5	-22	-22.5	V
$V_o$	Output Voltage	$I_o = -5\text{ mA to } -1\text{ A}$ $P_o \leq 15\text{ W}$ $V_i = -26\text{ to } -37\text{ V}$	-21.1	-22	-22.9	V
$\Delta V_o^*$	Line Regulation	$V_i = -25\text{ to } -37\text{ V}$ $T_j = 25^\circ\text{C}$ $V_i = -28\text{ to } -34\text{ V}$ $T_j = 25^\circ\text{C}$			440 220	mV mV
$\Delta V_o^*$	Load Regulation	$I_o = 5\text{ to } 1500\text{ mA}$ $T_j = 25^\circ\text{C}$ $I_o = 250\text{ to } 750\text{ mA}$ $T_j = 25^\circ\text{C}$			440 220	mV mV
$I_d$	Quiescent Current	$T_j = 25^\circ\text{C}$			3	mA
$\Delta I_d$	Quiescent Current Change	$I_o = 5\text{ to } 1000\text{ mA}$			0.5	mA
$\Delta I_d$	Quiescent Current Change	$V_i = -26\text{ to } -37\text{ V}$			1	mA
$\frac{\Delta V_o}{\Delta T}$	Output Voltage Drift	$I_o = 5\text{ mA}$		-1.1		mV/°C
$e_N$	Output Noise Voltage	$B = 10\text{Hz to } 100\text{KHz}$ $T_j = 25^\circ\text{C}$		375		$\mu\text{V}$
SVR	Supply Voltage Rejection	$\Delta V_i = 10\text{ V}$ $f = 120\text{ Hz}$	54	60		dB
$V_d$	Dropout Voltage	$I_o = 1\text{ A}$ $T_j = 25^\circ\text{C}$ $\Delta V_o = 100\text{ mV}$		1.1		V
$I_{sc}$	Short Circuit Current			1.1		A
$I_{scp}$	Short Circuit Peak Current	$T_j = 25^\circ\text{C}$		2.2		A

**ELECTRICAL CHARACTERISTICS FOR L7924A** (refer to the test circuits,  $T_j = 0$  to  $125^\circ\text{C}$ ,  
 $V_i = -33\text{V}$ ,  $I_o = 500\text{ mA}$ ,  $C_i = 2.2\ \mu\text{F}$ ,  $C_o = 1\ \mu\text{F}$  unless otherwise specified)

Symbol	Parameter	Test Conditions	Min.	Typ.	Max.	Unit
$V_o$	Output Voltage	$T_j = 25^\circ\text{C}$	-23.5	-24	-24.5	V
$V_o$	Output Voltage	$I_o = -5\text{ mA to } -1\text{ A}$ $P_o \leq 15\text{ W}$ $V_i = -27\text{ to } -38\text{ V}$	-23	-24	-25	V
$\Delta V_o^*$	Line Regulation	$V_i = -27\text{ to } -38\text{ V}$ $T_j = 25^\circ\text{C}$ $V_i = -30\text{ to } -36\text{ V}$ $T_j = 25^\circ\text{C}$			480 240	mV mV
$\Delta V_o^*$	Load Regulation	$I_o = 5\text{ to } 1500\text{ mA}$ $T_j = 25^\circ\text{C}$ $I_o = 250\text{ to } 750\text{ mA}$ $T_j = 25^\circ\text{C}$			480 240	mV mV
$I_d$	Quiescent Current	$T_j = 25^\circ\text{C}$			3	mA
$\Delta I_d$	Quiescent Current Change	$I_o = 5\text{ to } 1000\text{ mA}$			0.5	mA
$\Delta I_d$	Quiescent Current Change	$V_i = -27\text{ to } -38\text{ V}$			1	mA
$\frac{\Delta V_o}{\Delta T}$	Output Voltage Drift	$I_o = 5\text{ mA}$		-1		mV/°C
$e_N$	Output Noise Voltage	$B = 10\text{Hz to } 100\text{KHz}$ $T_j = 25^\circ\text{C}$		400		$\mu\text{V}$
SVR	Supply Voltage Rejection	$\Delta V_i = 10\text{ V}$ $f = 120\text{ Hz}$	54	60		dB
$V_d$	Dropout Voltage	$I_o = 1\text{ A}$ $T_j = 25^\circ\text{C}$ $\Delta V_o = 100\text{ mV}$		1.1		V
$I_{sc}$	Short Circuit Current			1.1		A
$I_{scp}$	Short Circuit Peak Current	$T_j = 25^\circ\text{C}$		2.2		A

\* Load and line regulation are specified at constant junction temperature. Changes in  $V_o$  due to heating effects must be taken into account separately. Pulse testing with low duty cycle is used.

7929237 0051482 714

APPLICATION INFORMATION

Figure 1 : Fixed Output Regulator.

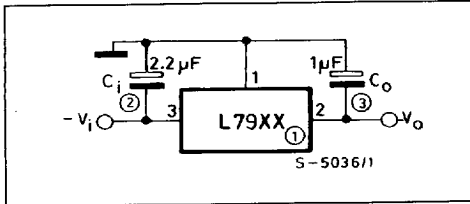

- Notes :
1. To specify an output voltage, substitute voltage value for "XX".
  2. Required for stability. For value given, capacitor must be solid tantalum. If aluminium electrolytics are used, at least ten times value shown should be selected, Ci is required if regulator is located an appreciable distance from power supply filter.
  3. To improve transient response. If large capacitors are used, a high current diode from input to output (1N4001 or similar) should be introduced to protect the device from momentary input short circuit.

Figure 3 : Circuit for Increasing Output Voltage.

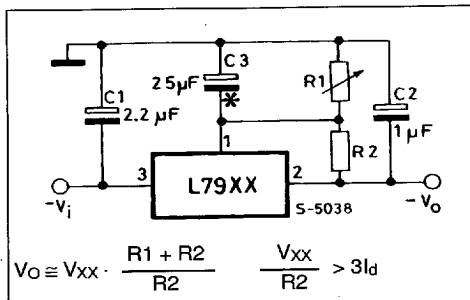

\* C3 Optional for improved transient response and ripple rejection.

Figure 5 : Typical ECL System Power Supply (-5.2V/4A).

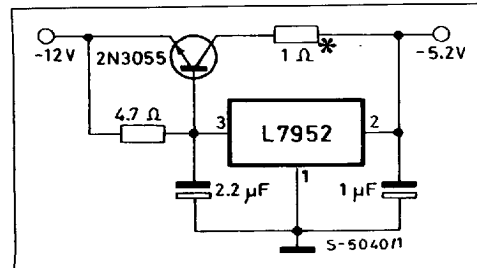

\* Optional dropping resistor to reduce the power dissipated in the boost transistor.

Figure 2 : Split Power Supply (± 15V/1A).

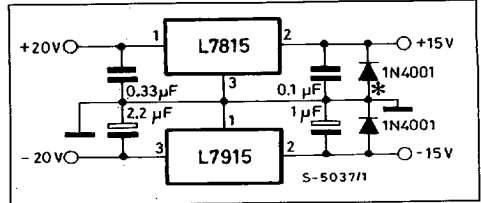

\* Against potential latch-up problems.

Figure 4 : High Current Negative Regulator (-5V/4A with 5A current limiting).

