

## 1% High-Accuracy, 1-A, Low-Dropout Regulator with Reverse Current Protection

### FEATURES

- **Stable with 1.0  $\mu$ F or Larger Ceramic Output Capacitor**
- **Input Voltage Range: 2.2 V to 5.5 V**
- **Ultralow Dropout Voltage:**
  - 200 mV max at 1 A
- **Excellent Load Transient Response—Even with Only 1.0- $\mu$ F Output Capacitor**
- **NMOS Topology Delivers Low Reverse Leakage Current**
- **Excellent Accuracy:**
  - 0.23% Nominal Accuracy
  - 1% Overall Accuracy Over Line, Load, and Temperature
- **Less Than 20 nA typical  $I_Q$  in Shutdown Mode**
- **Thermal Shutdown and Current Limit for Fault Protection**

### APPLICATIONS

- **Point of Load Regulation for DSPs, FPGAs, ASICs, and Microprocessors**
- **Post-Regulation for Switching Supplies**
- **Portable/Battery-Powered Equipment**

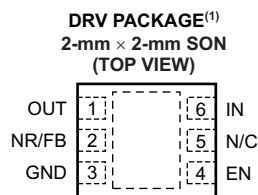

(1) Power dissipation may limit operating range. Check [Thermal Information](#) table.

### DESCRIPTION

The TPS7A37xx family of linear low-dropout (LDO) voltage regulators uses an NMOS pass element in a voltage-follower configuration. This topology is relatively insensitive to output capacitor value and ESR, allowing a wide variety of load configurations. Load transient response is excellent, even with a small 1.0- $\mu$ F ceramic output capacitor. The NMOS topology also allows very low dropout.

The TPS7A37xx family uses an advanced BiCMOS process to yield high precision while delivering very low dropout voltages and low ground pin current. Current consumption, when not enabled, is under 20 nA and ideal for portable applications. These devices are protected by thermal shutdown and foldback current limit.

### TYPICAL APPLICATION CIRCUITS

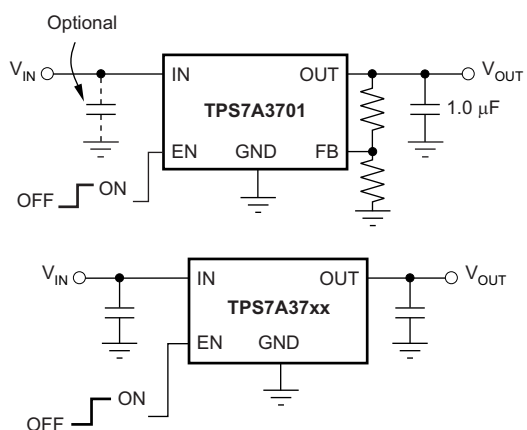

Please be aware that an important notice concerning availability, standard warranty, and use in critical applications of Texas Instruments semiconductor products and disclaimers thereto appears at the end of this data sheet.

All trademarks are the property of their respective owners.



This integrated circuit can be damaged by ESD. Texas Instruments recommends that all integrated circuits be handled with appropriate precautions. Failure to observe proper handling and installation procedures can cause damage.

ESD damage can range from subtle performance degradation to complete device failure. Precision integrated circuits may be more susceptible to damage because very small parametric changes could cause the device not to meet its published specifications.

### ORDERING INFORMATION<sup>(1)</sup>

PRODUCT	V <sub>OUT</sub> <sup>(2)</sup>
TPS7A37xx yyy z	<b>XX</b> is nominal output voltage (for example, 25 = 2.5V, 01 = Adjustable <sup>(3)</sup> ). <b>YYY</b> is package designator. <b>Z</b> is package quantity.

- (1) For the most current package and ordering information see the Package Option Addendum at the end of this document, or visit the device product folder at [www.ti.com](http://www.ti.com).
- (2) Most output voltages of 1.25 V and 1.3 V to 5.0 V in 100-mV increments are available on a quick-turn basis using innovative factory package-level programming. Minimum order quantities apply; contact factory for details and availability.
- (3) For fixed 1.20-V operation, tie FB to OUT.

### ABSOLUTE MAXIMUM RATINGS<sup>(1)</sup>

Over operating temperature range (unless otherwise noted).

		VALUE		UNIT
		MIN	MAX	
Voltage	IN	-0.3	+6.0	V
	EN	-0.3	+6.0	V
	OUT	-0.3	+5.5	V
	NR, FB	-0.3	+6.0	V
Current	Peak output current	Internally limited		A
	Output short-circuit duration	Indefinite		A
Temperature	Operating junction, T <sub>J</sub>	-55	+150	°C
	Storage, T <sub>stg</sub>	-65	+150	°C
Electrostatic discharge (ESD) ratings	Human body model (HBM)	2		kV
	Charged device model (CDM)	500		V

- (1) Stresses beyond those listed under *Absolute Maximum Ratings* may cause permanent damage to the device. These are stress ratings only, and functional operation of the device at these or any other conditions beyond those indicated under the *Electrical Characteristics* is not implied. Exposure to absolute maximum rated conditions for extended periods may affect device reliability.

### THERMAL INFORMATION

THERMAL METRIC <sup>(1)</sup>		TPS7A37xx	UNITS
		DRV	
		6 PINS	
θ <sub>JA</sub>	Junction-to-ambient thermal resistance	67.2	°C/W
θ <sub>JCtop</sub>	Junction-to-case (top) thermal resistance	87.6	
θ <sub>JB</sub>	Junction-to-board thermal resistance	36.8	
ψ <sub>JT</sub>	Junction-to-top characterization parameter	1.8	
ψ <sub>JB</sub>	Junction-to-board characterization parameter	37.2	
θ <sub>JCbot</sub>	Junction-to-case (bottom) thermal resistance	7.7	

- (1) For more information about traditional and new thermal metrics, see the *IC Package Thermal Metrics* application report, [SPRA953A](http://www.ti.com/lit/zip/Spra953a).

## ELECTRICAL CHARACTERISTICS

Over operating temperature range ( $T_J = -40^\circ\text{C}$  to  $+125^\circ\text{C}$ ),  $V_{IN} = V_{OUT(nom)} + 1.0\text{ V}^{(1)}$ ,  $I_{OUT} = 10\text{ mA}$ ,  $V_{EN} = 2.2\text{ V}$ , and  $C_{OUT} = 2.2\text{ }\mu\text{F}$ , unless otherwise noted. Typical values are at  $T_J = +25^\circ\text{C}$ .

PARAMETER	TEST CONDITIONS	TPS7A37xx			UNIT
		MIN	TYP	MAX	
$V_{IN}$ Input voltage range <sup>(1)(2)</sup>		2.2		5.5	V
$V_{FB}$ Internal reference	$T_J = +25^\circ\text{C}$	1.192	1.2	1.216	V
$V_{OUT}$	Output voltage range	TPS7A3701 <sup>(3)(4)</sup>			V
	Accuracy <sup>(1)</sup> , <sup>(5)</sup>	Nominal	$T_J = +25^\circ\text{C}$		
		over $V_{IN}$ , $I_{OUT}$ , and $T_J = -40^\circ\text{C}$ to $+125^\circ\text{C}$	$V_{OUT} + 0.5\text{ V} \leq V_{IN} \leq 5.5\text{ V}$ ; $10\text{ mA} \leq I_{OUT} \leq 1\text{ A}$		
$\Delta V_{O(\Delta VI)}$ Line regulation <sup>(1)</sup>	$V_{OUT(nom)} + 0.5\text{ V} \leq V_{IN} \leq 5.5\text{ V}$		0.01	0.03	%/V
$\Delta V_{O(\Delta IO)}$ Load regulation	$0.1\text{ mA} \leq I_{OUT} \leq 300\text{ mA}$		0.25%	0.35%	
			3.0	5.0	mV
	$10\text{ mA} \leq I_{OUT} \leq 1\text{ A}$		0.5%		
$V_{DO}$ Dropout voltage <sup>(6)</sup> ( $V_{IN} = V_{OUT(nom)} - 0.1\text{ V}$ )	$I_{OUT} = 1\text{ A}$		130	200	mV
$Z_O(\text{DO})$ Output impedance in dropout	$2.2\text{ V} \leq V_{IN} \leq V_{OUT} + V_{DO}$		0.25		$\Omega$
$I_{CL}$ Output current limit	$V_{OUT} = 0.9 \times V_{OUT(nom)}$	1.05	1.6	2.2	A
$I_{SC}$ Short-circuit current	$V_{OUT} = 0\text{ V}$		450		mA
$I_{REV}$ Reverse leakage current <sup>(7)</sup> ( $-I_{IN}$ )	$V_{EN} \leq 0.5\text{ V}$ , $0\text{ V} \leq V_{IN} \leq V_{OUT}$		0.1		$\mu\text{A}$
$I_{GND}$ GND pin current	$I_{OUT} = 10\text{ mA}$ ( $I_Q$ )		400		$\mu\text{A}$
	$I_{OUT} = 1\text{ A}$		1300		
$I_{SHDN}$ Shutdown current ( $I_{GND}$ )	$V_{EN} \leq 0.5\text{ V}$ , $V_{OUT} \leq V_{IN} \leq 5.5\text{ V}$		20		nA
$I_{FB}$ FB pin current	TPS7A3701 <sup>(3)</sup>		0.1	0.6	$\mu\text{A}$
PSRR Power-supply rejection ratio (ripple rejection)	$f = 100\text{ Hz}$ , $I_{OUT} = 1\text{ A}$		58		dB
	$f = 10\text{ kHz}$ , $I_{OUT} = 1\text{ A}$		37		
$V_N$ Output noise voltage BW = 10 Hz to 100 kHz	$C_{OUT} = 10\text{ }\mu\text{F}$		$27 \times V_{OUT}$		$\mu\text{V}_{RMS}$
$t_{STR}$ Startup time	$V_{OUT} = 3\text{ V}$ , $R_L = 30\text{ }\Omega$ , $C_{OUT} = 1\text{ }\mu\text{F}$		600		$\mu\text{s}$
$V_{EN(HI)}$ EN pin high (enabled)		1.7		$V_{IN}$	V
$V_{EN(LO)}$ EN pin low (shutdown)		0		0.5	V
$I_{EN(HI)}$ EN pin current (enabled)	$V_{EN} = 5.5\text{ V}$		20		nA
$T_{SD}$ Thermal shutdown temperature	Shutdown, temperature increasing		+160		$^\circ\text{C}$
	Reset, temperature decreasing		+140		
$T_J$ Operating junction temperature		-40		+125	$^\circ\text{C}$

(1) Minimum  $V_{IN} = V_{OUT} + V_{DO}$  or 2.2 V, whichever is greater.

(2) For  $V_{OUT(nom)} < 1.6\text{ V}$ , when  $V_{IN} \leq 1.6\text{ V}$ , the output will lock to  $V_{IN}$  and may result in an over-voltage condition on the output. To avoid this situation, disable the device before powering down  $V_{IN}$ .

(3) TPS7A3701 (adjustable-voltage version) is product-preview device.

(4) TPS7A3701 is tested at  $V_{OUT} = 1.2\text{ V}$ .

(5) Tolerance of external resistors not included in this specification.

(6)  $V_{DO}$  is not measured for fixed output versions with  $V_{OUT(nom)} < 2.3\text{ V}$  since minimum  $V_{IN} = 2.2\text{ V}$ .

(7) Fixed-voltage versions only; refer to the [Applications](#) section for more information.

FUNCTIONAL BLOCK DIAGRAMS

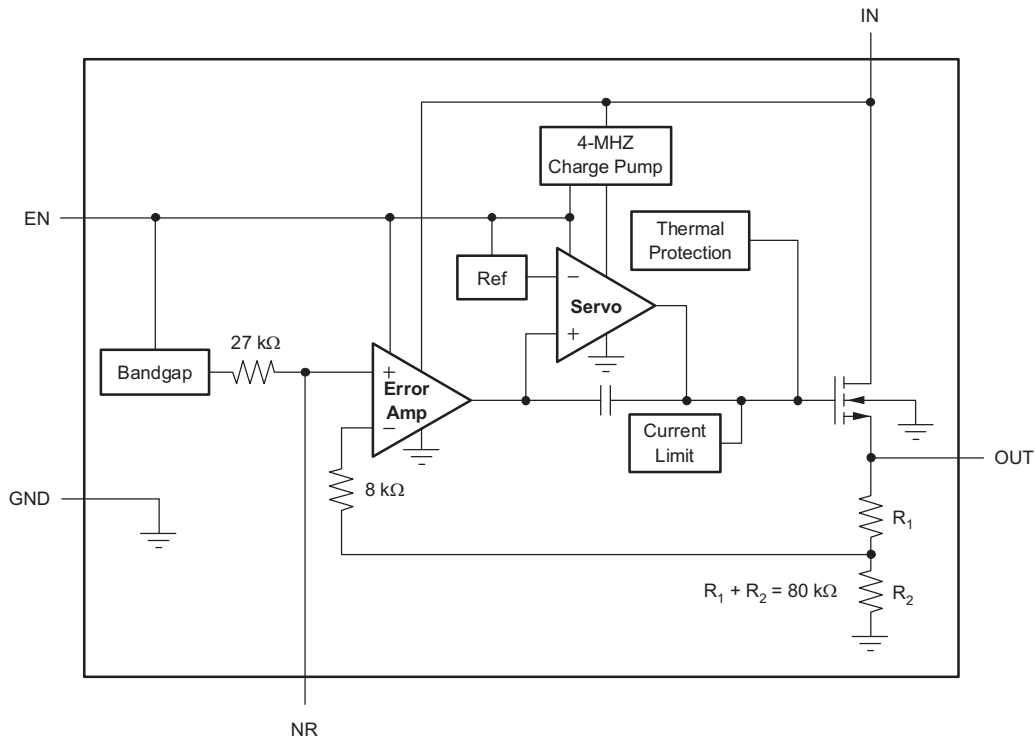

Figure 1. Fixed Voltage Version

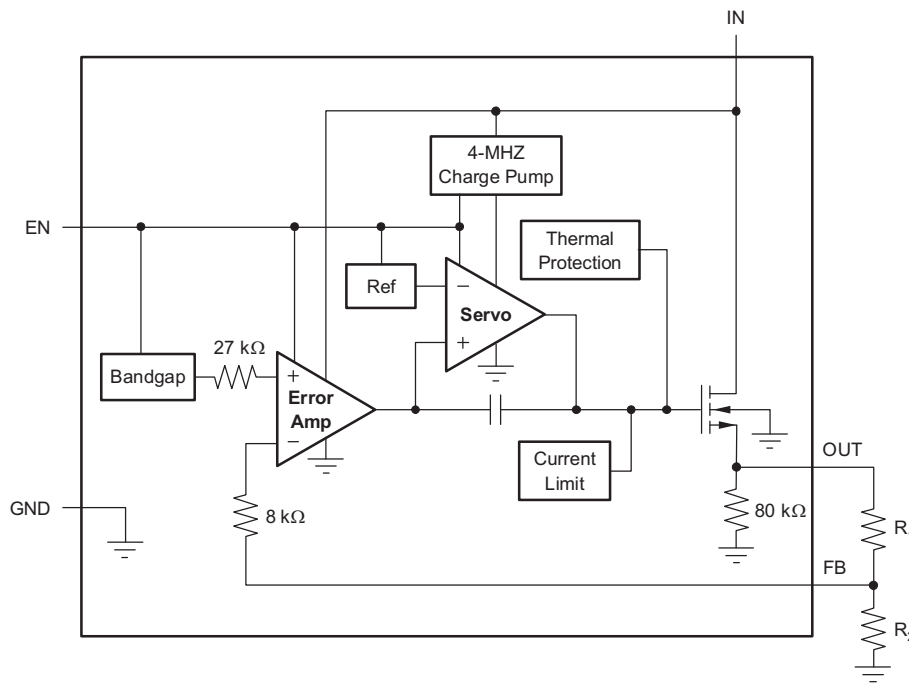

Figure 2. Adjustable Voltage Version (Product-Preview Device)

Standard 1% Resistor Values for Common Output Voltages

V <sub>O</sub>	R <sub>1</sub>	R <sub>2</sub>
1.2 V	Short	Open
1.5 V	23.2 kΩ	95.3 kΩ
1.8 V	28.0 kΩ	56.2 kΩ
2.5 V	39.2 kΩ	36.5 kΩ
2.8 V	44.2 kΩ	33.2 kΩ
3.0 V	46.4 kΩ	30.9 kΩ
3.3 V	52.3 kΩ	30.1 kΩ

NOTE:  $V_{OUT} = (R_1 + R_2)/R_2 \times 1.204$ ;  
 $R_1 \parallel R_2 \cong 19 \text{ k}\Omega$  for best accuracy.

## PIN CONFIGURATIONS

**DRV PACKAGE<sup>(1)</sup>**  
**2mm x 2mm SON**  
**(TOP VIEW)**

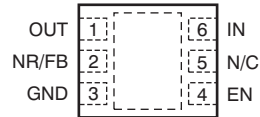

(1) Power dissipation may limit operating range. Check [Thermal Information](#) table.

## PIN DESCRIPTIONS

PIN NAME	PIN NO.	DESCRIPTION
EN	4	Driving the enable pin (EN) high turns on the regulator. Driving this pin low puts the regulator into shutdown mode. Refer to the <a href="#">Shutdown</a> section under <a href="#">Applications Information</a> for more details. EN must not be left floating and can be connected to IN if not used.
FB	2	Adjustable voltage version <sup>(1)</sup> only—this pin is the input to the control loop error amplifier, and is used to set the output voltage of the device.
GND	3, Pad	Ground
IN	6	Unregulated input supply
NC	5	Not connected
NR	2	Fixed voltage versions only—connecting an external capacitor to this pin bypasses noise generated by the internal bandgap, reducing output noise to very low levels.
OUT	1	Regulator output. A 1.0- $\mu$ F or larger capacitor of any type is required for stability.

(1) TPS7A3701 (adjustable-voltage version) is product-preview device.

### TYPICAL CHARACTERISTICS

For all voltage versions at  $T_J = +25^\circ\text{C}$ ,  $V_{IN} = V_{OUT(nom)} + 1.0\text{ V}$ ,  $I_{OUT} = 10\text{ mA}$ ,  $V_{EN} = 2.2\text{ V}$ , and  $C_{OUT} = 2.2\text{ }\mu\text{F}$ , unless otherwise noted.

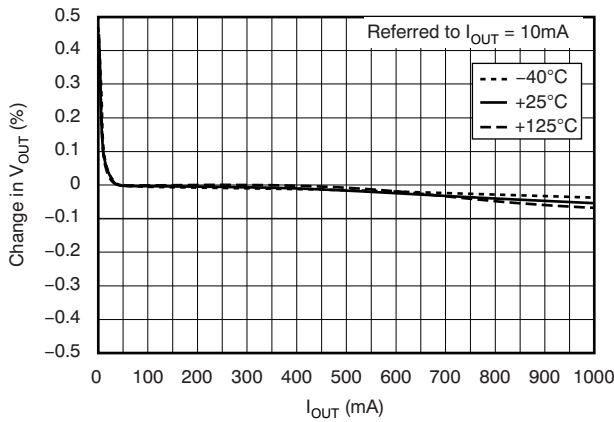

Figure 3. LOAD REGULATION

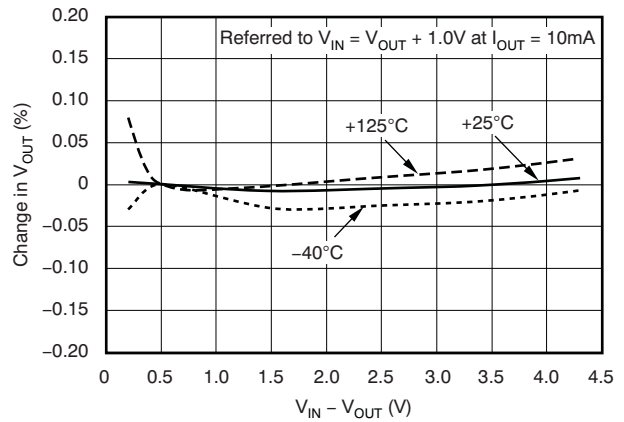

Figure 4. LINE REGULATION

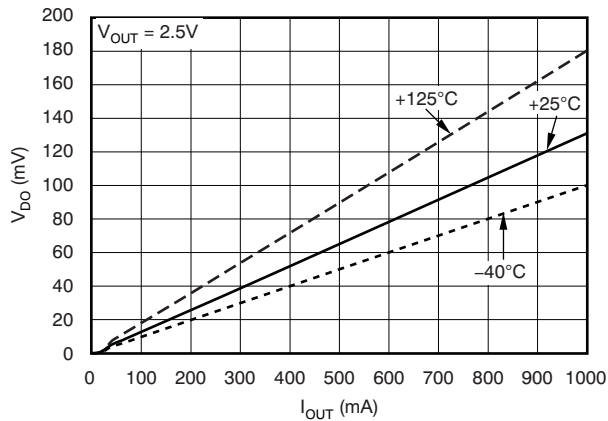

Figure 5. DROPOUT VOLTAGE vs OUTPUT CURRENT

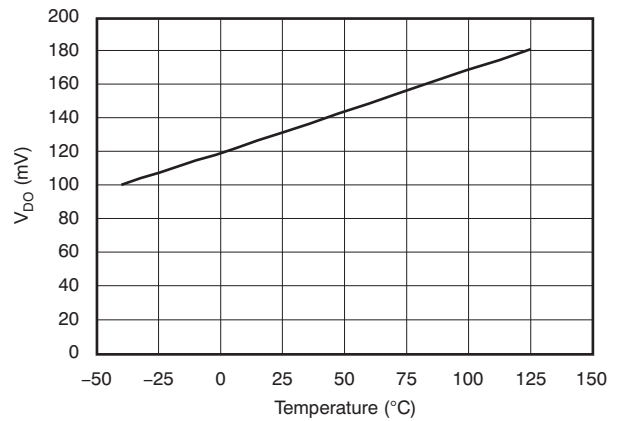

Figure 6. DROPOUT VOLTAGE vs TEMPERATURE

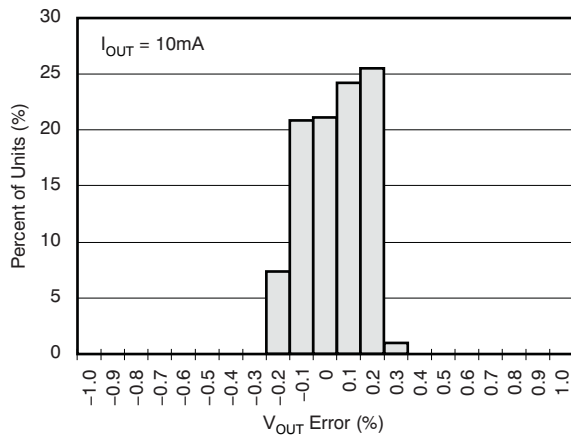

Figure 7. OUTPUT VOLTAGE HISTOGRAM

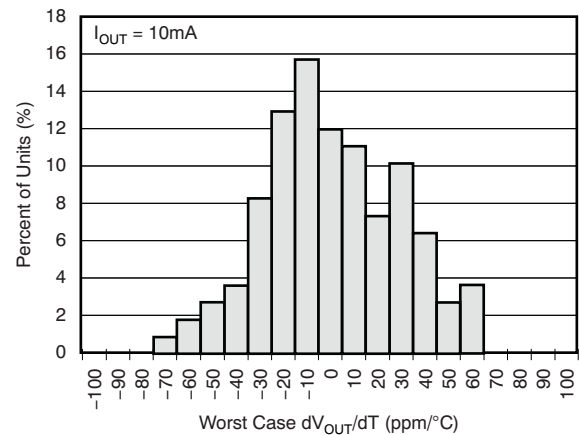
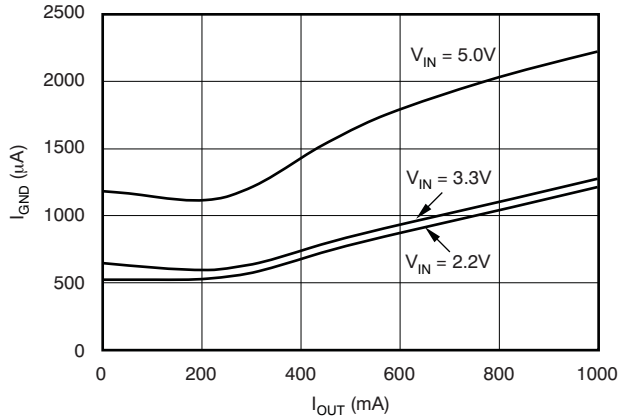

Figure 8. OUTPUT VOLTAGE DRIFT HISTOGRAM

**TYPICAL CHARACTERISTICS (continued)**

For all voltage versions at  $T_J = +25^\circ\text{C}$ ,  $V_{IN} = V_{OUT(nom)} + 1.0\text{ V}$ ,  $I_{OUT} = 10\text{ mA}$ ,  $V_{EN} = 2.2\text{ V}$ , and  $C_{OUT} = 2.2\text{ }\mu\text{F}$ , unless otherwise noted.



**Figure 9. GROUND PIN CURRENT vs OUTPUT CURRENT**

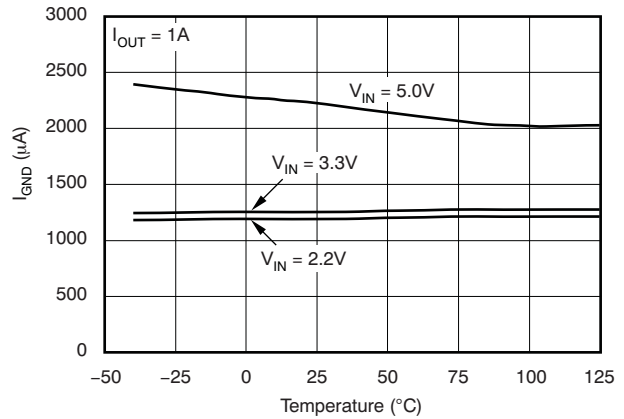

**Figure 10. GROUND PIN CURRENT vs TEMPERATURE**

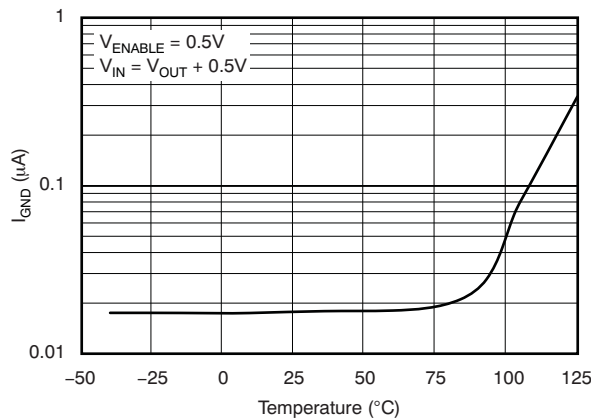

**Figure 11. GROUND PIN CURRENT IN SHUTDOWN vs TEMPERATURE**

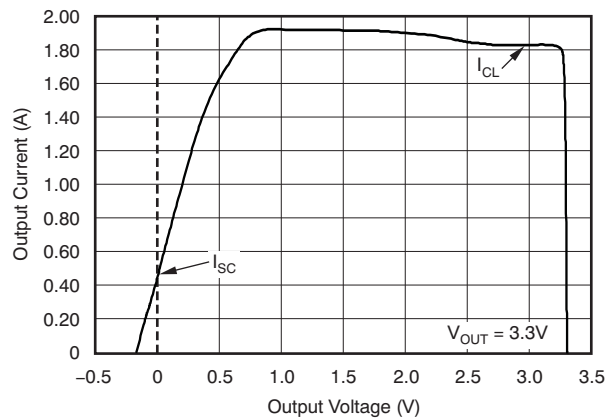

**Figure 12. CURRENT LIMIT vs  $V_{OUT}$  (FOLDBACK)**

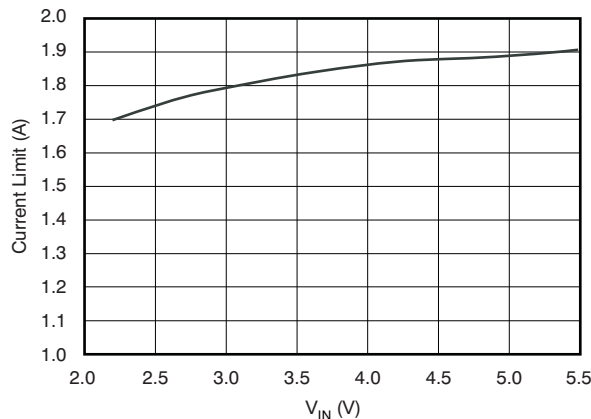

**Figure 13. CURRENT LIMIT vs  $V_{IN}$**

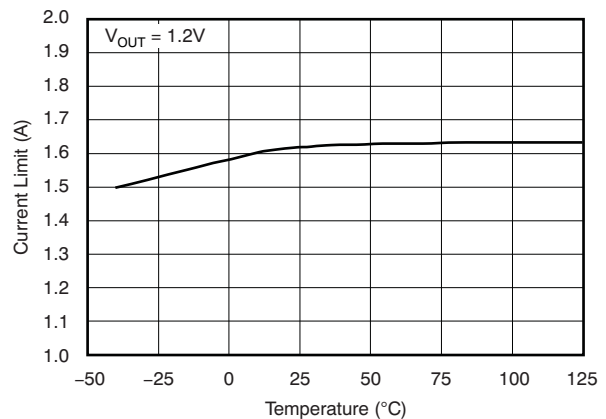

**Figure 14. CURRENT LIMIT vs TEMPERATURE**

**TYPICAL CHARACTERISTICS (continued)**

For all voltage versions at  $T_J = +25^\circ\text{C}$ ,  $V_{IN} = V_{OUT(nom)} + 1.0\text{ V}$ ,  $I_{OUT} = 10\text{ mA}$ ,  $V_{EN} = 2.2\text{ V}$ , and  $C_{OUT} = 2.2\text{ }\mu\text{F}$ , unless otherwise noted.

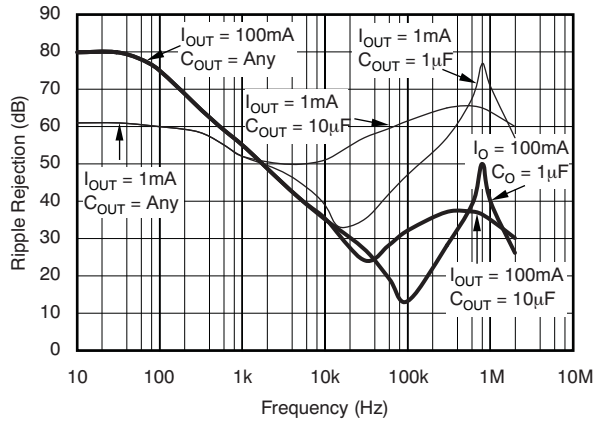

Figure 15. PSRR (RIPPLE REJECTION) vs FREQUENCY

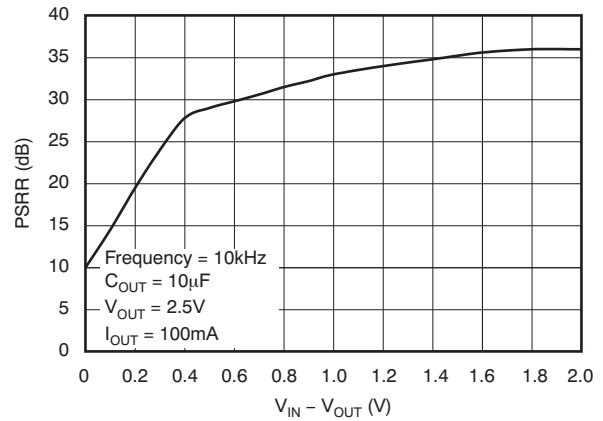

Figure 16. PSRR (RIPPLE REJECTION) vs  $V_{IN} - V_{OUT}$

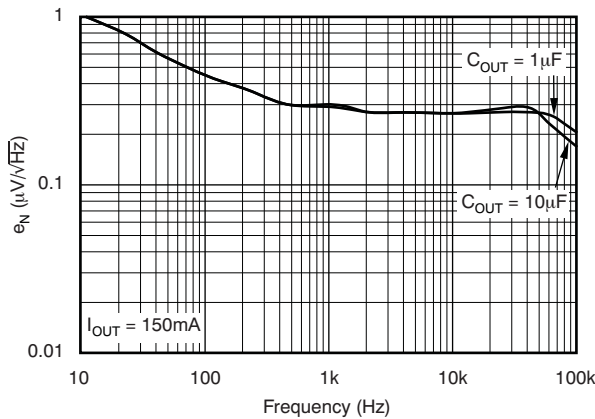

Figure 17. NOISE SPECTRAL DENSITY

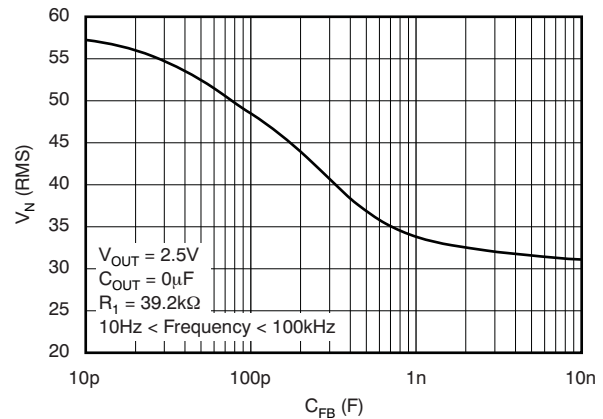

Figure 18. TPS7A3701: RMS NOISE VOLTAGE vs  $C_{FB}$

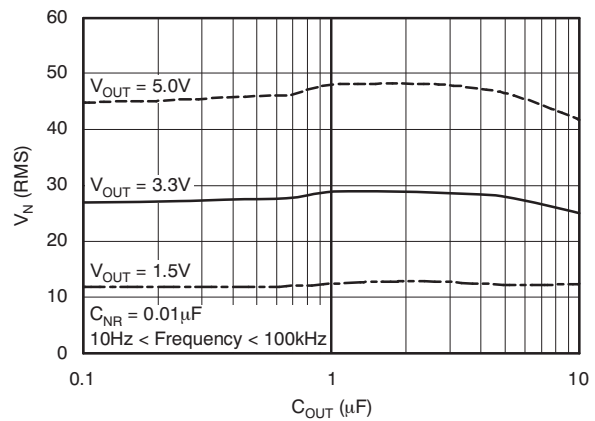

Figure 19. RMS NOISE VOLTAGE vs  $C_{OUT}$

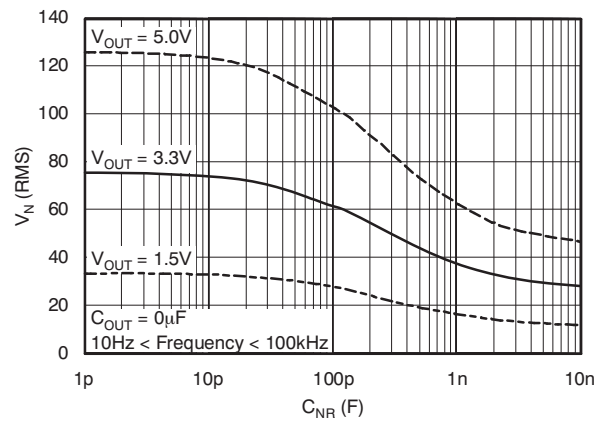

Figure 20. RMS NOISE VOLTAGE vs  $C_{NR}$



**TYPICAL CHARACTERISTICS (continued)**

For all voltage versions at  $T_J = +25^\circ\text{C}$ ,  $V_{IN} = V_{OUT(nom)} + 1.0\text{ V}$ ,  $I_{OUT} = 10\text{ mA}$ ,  $V_{EN} = 2.2\text{ V}$ , and  $C_{OUT} = 2.2\text{ }\mu\text{F}$ , unless otherwise noted.

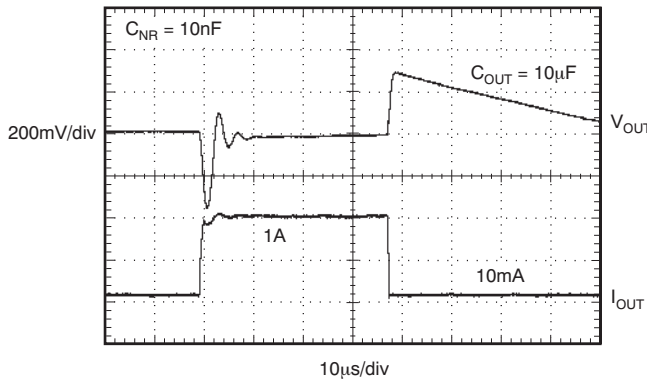

Figure 21. TPS7A3733: LOAD TRANSIENT RESPONSE

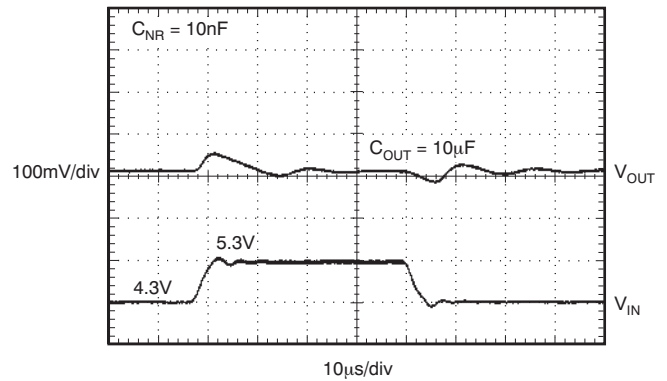

Figure 22. TPS7A3733: LINE TRANSIENT RESPONSE

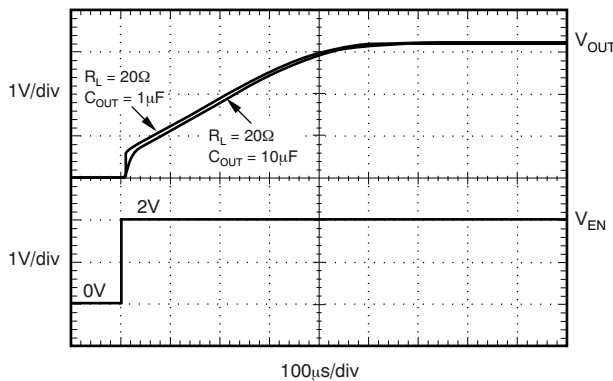

Figure 23. TPS7A3701: TURN-ON RESPONSE

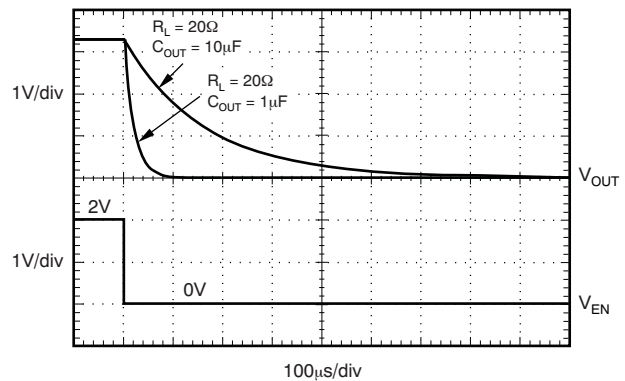

Figure 24. TPS7A3701: TURN-OFF RESPONSE

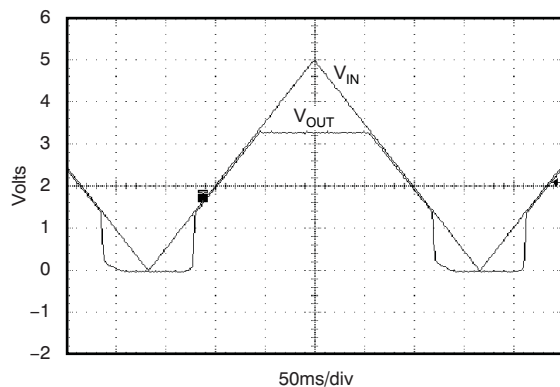

Figure 25. TPS7A3701: POWER-UP/POWER-DOWN ( $V_{OUT} = 3.3\text{V}$ )

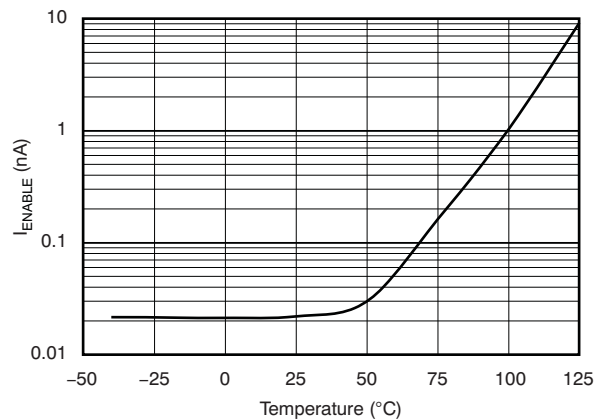

Figure 26.  $I_{ENABLE}$  VS TEMPERATURE

**TYPICAL CHARACTERISTICS (continued)**

For all voltage versions at  $T_J = +25^\circ\text{C}$ ,  $V_{IN} = V_{OUT(nom)} + 1.0\text{ V}$ ,  $I_{OUT} = 10\text{ mA}$ ,  $V_{EN} = 2.2\text{ V}$ , and  $C_{OUT} = 2.2\text{ }\mu\text{F}$ , unless otherwise noted.

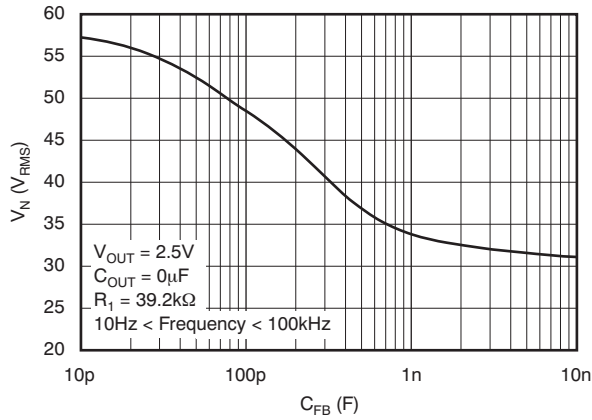

Figure 27. TPS7A3701: RMS NOISE VOLTAGE vs  $C_{FB}$

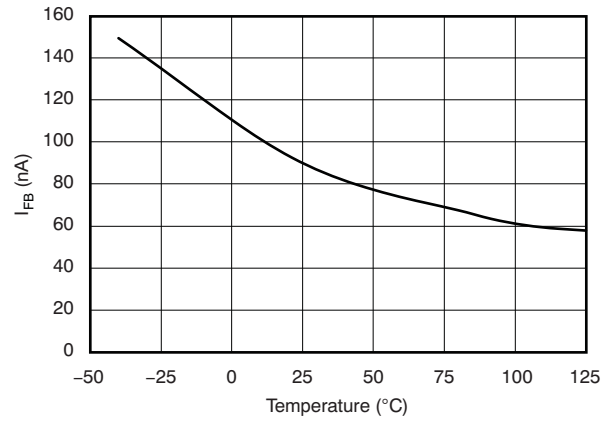

Figure 28. TPS7A3701:  $I_{FB}$  vs TEMPERATURE

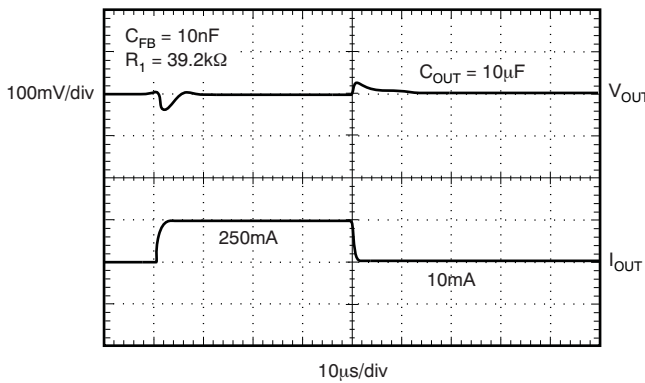

Figure 29. TPS7A3701: LOAD TRANSIENT, ADJUSTABLE VERSION

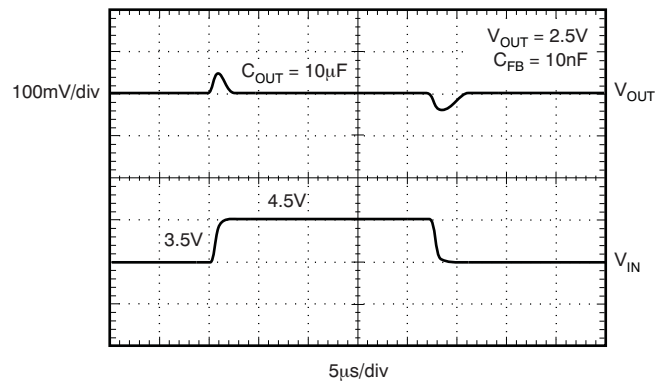
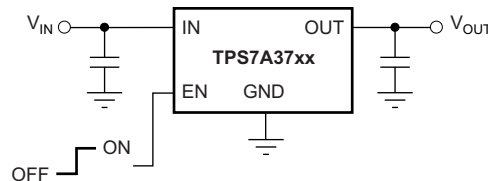

Figure 30. TPS7A3701: LINE TRANSIENT, ADJUSTABLE VERSION

## APPLICATION INFORMATION

The TPS7A37xx belongs to a family of new generation LDO regulators that use an NMOS pass transistor to achieve ultra-low-dropout performance, reverse current blockage, and freedom from output capacitor constraints. These features combined with an enable input make the TPS7A37xx ideal for portable applications. This regulator family offers a wide selection of fixed output voltage versions and an adjustable output version. All versions have thermal and over-current protection, including foldback current limit.

Figure 31 shows the basic circuit connections for the fixed voltage models. Figure 32 gives the connections for the adjustable output version, TPS7A3701 <sup>(1)</sup>.



**Figure 31. Typical Application Circuit for Fixed-Voltage Version**

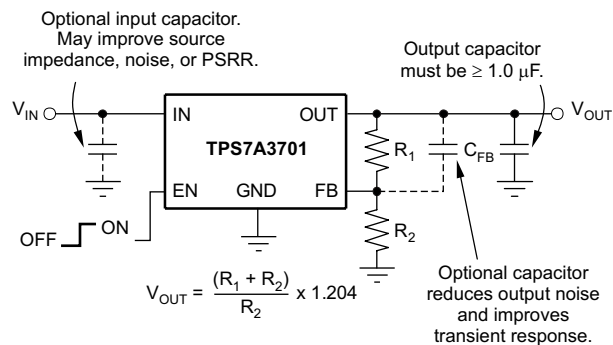

**Figure 32. Typical Application Circuit for Adjustable-Voltage Version<sup>(1)</sup>**

$R_1$  and  $R_2$  can be calculated for any output voltage using the formula shown in Figure 32. Sample resistor values for common output voltages are shown in Figure 2.

For best accuracy, make the parallel combination of  $R_1$  and  $R_2$  approximately equal to 19 k $\Omega$ . This 19 k $\Omega$ , in addition to the internal 8-k $\Omega$  resistor, presents the same impedance to the error amp as the 27-k $\Omega$  bandgap reference output. This impedance helps compensate for leakages into the error amp terminals.

## INPUT AND OUTPUT CAPACITOR REQUIREMENTS

Although an input capacitor is not required for stability if input impedance is very low, it is good analog design practice to connect a 0.1- $\mu$ F to 1- $\mu$ F low equivalent series resistance (ESR) capacitor across the input supply near the regulator. This capacitor counteracts reactive input sources and improves transient response, noise rejection, and ripple rejection. A higher-value capacitor may be necessary if large, fast rise-time load transients are anticipated or the device is located several inches from the power source.

The TPS7A37xx requires a 1.0- $\mu$ F output capacitor for stability. It is designed to be stable for all available types and values of capacitors. In applications where multiple low ESR capacitors are in parallel, ringing may occur when the product of  $C_{OUT}$  and total ESR drops below 50 n $\Omega$ F (TBD - what is "n $\Omega$ F"?). Total ESR includes all parasitic resistances, including capacitor ESR and board, socket, and solder joint resistance. In most applications, the sum of capacitor ESR and trace resistance will meet this requirement.

(1) Product-preview device.

## OUTPUT NOISE

A precision bandgap reference is used to generate the internal reference voltage,  $V_{REF}$ . This reference is the dominant noise source within the TPS7A37xx and it generates approximately  $32 \mu V_{RMS}$  (10 Hz to 100 kHz) at the reference output (NR). The regulator control loop gains up the reference noise with the same gain as the reference voltage, so that the noise voltage of the regulator is approximately given by:

$$V_N = 32 \mu V_{RMS} \times \frac{(R_1 + R_2)}{R_2} = 32 \mu V_{RMS} \times \frac{V_{OUT}}{V_{REF}} \quad (1)$$

Since the value of  $V_{REF}$  is 1.2V, this relationship reduces to:

$$V_N(\mu V_{RMS}) = 27 \left( \frac{\mu V_{RMS}}{V} \right) \times V_{OUT} (V) \quad (2)$$

for the case of no  $C_{NR}$ .

An internal 27-k $\Omega$  resistor in series with the noise reduction pin (NR) forms a low-pass filter for the voltage reference when an external noise reduction capacitor,  $C_{NR}$ , is connected from NR to ground. For  $C_{NR} = 10$  nF, the total noise in the 10-Hz to 100-kHz bandwidth is reduced by a factor of  $\sim 3.2$ , giving the approximate relationship:

$$V_N(\mu V_{RMS}) = 8.5 \left( \frac{\mu V_{RMS}}{V} \right) \times V_{OUT} (V) \quad (3)$$

for  $C_{NR} = 10$  nF.

This noise reduction effect is shown as RMS Noise Voltage vs  $C_{NR}$  in the [Typical Characteristics](#) section.

The TPS7A3701 adjustable version does not have the NR pin available. However, connecting a feedback capacitor,  $C_{FB}$ , from the output to the feedback pin (FB) reduces output noise and improve load transient performance. This capacitor should be limited to 0.1  $\mu F$ .

The TPS7A37xx uses an internal charge pump to develop an internal supply voltage sufficient to drive the gate of the NMOS pass element above  $V_{OUT}$ . The charge pump generates  $\sim 250 \mu V$  of switching noise at  $\sim 4$  MHz; however, charge-pump noise contribution is negligible at the output of the regulator for most values of  $I_{OUT}$  and  $C_{OUT}$ .

## BOARD LAYOUT RECOMMENDATION TO IMPROVE PSRR AND NOISE PERFORMANCE

To improve ac performance such as PSRR, output noise, and transient response, it is recommended that the printed circuit board (PCB) be designed with separate ground planes for  $V_{IN}$  and  $V_{OUT}$ , with each ground plane connected only at the GND pin of the device. In addition, the ground connection for the bypass capacitor should connect directly to the GND pin of the device.

## INTERNAL CURRENT LIMIT

The TPS7A37xx internal current limit helps protect the regulator during fault conditions. Foldback current limit helps to protect the regulator from damage during output short-circuit conditions by reducing current limit when  $V_{OUT}$  drops below 0.5 V. See [Figure 12](#) in the [Typical Characteristics](#) section.

Note from [Figure 12](#) that approximately  $-0.2$  V of  $V_{OUT}$  results in a current limit of 0 mA. Therefore, if OUT is forced below  $-0.2$  V before EN goes high, the device may not start up. In applications that work with both a positive and negative voltage supply, the TPS7A37xx should be enabled first.

## ENABLE PIN AND SHUTDOWN

The enable pin (EN) is active high and is compatible with standard TTL-CMOS levels. A  $V_{EN}$  below 0.5 V (max) turns the regulator off and drops the GND pin current to approximately 10 nA. When EN is used to shutdown the regulator, all charge is removed from the pass transistor gate, and the output ramps back up to a regulated  $V_{OUT}$  (see [Figure 23](#)).

When shutdown capability is not required, EN can be connected to  $V_{IN}$ . However, the pass gate may not be discharged using this configuration, and the pass transistor may be left on (enhanced) for a significant time after  $V_{IN}$  has been removed. This scenario can result in reverse current flow (if the IN pin is low impedance) and faster ramp times upon power-up. In addition, for  $V_{IN}$  ramp times slower than a few milliseconds, the output may overshoot upon power-up.

Note that current limit foldback can prevent device start-up under some conditions. See the [Internal Current Limit](#) section for more information.

## DROPOUT VOLTAGE

The TPS7A37xx uses an NMOS pass transistor to achieve extremely low dropout. When  $(V_{IN} - V_{OUT})$  is less than the dropout voltage ( $V_{DO}$ ), the NMOS pass device is in its linear region of operation and the input-to-output resistance is the  $R_{DS, ON}$  of the NMOS pass element.

For large step changes in load current, the TPS7A37xx requires a larger voltage drop from  $V_{IN}$  to  $V_{OUT}$  to avoid degraded transient response. The boundary of this transient dropout region is approximately twice the dc dropout. Values of  $V_{IN} - V_{OUT}$  above this line ensure normal transient response.

Operating in the transient dropout region can cause an increase in recovery time. The time required to recover from a load transient is a function of the magnitude of the change in load current rate, the rate of change in load current, and the available headroom ( $V_{IN}$  to  $V_{OUT}$  voltage drop). Under worst-case conditions [full-scale instantaneous load change with  $(V_{IN} - V_{OUT})$  close to dc dropout levels], the TPS7A37xx can take a couple of hundred microseconds to return to the specified regulation accuracy.

## TRANSIENT RESPONSE

The low open-loop output impedance provided by the NMOS pass element in a voltage follower configuration allows operation without a 1.0- $\mu$ F output capacitor. As with any regulator, the addition of additional capacitance from the OUT pin to ground reduces undershoot magnitude but increases its duration. In the adjustable version, the addition of a capacitor,  $C_{FB}$ , from the OUT pin to the FB pin will also improve the transient response.

The TPS7A37xx does not have active pull-down when the output is over-voltage. This architecture allows applications that connect higher voltage sources, such as alternate power supplies, to the output. This architecture also results in an output overshoot of several percent if the load current quickly drops to zero when a capacitor is connected to the output. The duration of overshoot can be reduced by adding a load resistor. The overshoot decays at a rate determined by output capacitor  $C_{OUT}$  and the internal/external load resistance. The rate of decay is given by:

(Fixed voltage version)

$$\frac{dV}{dT} = \frac{V_{OUT}}{C_{OUT} \times 80k\Omega \parallel R_{LOAD}} \quad (4)$$

(Adjustable voltage version)

$$\frac{dV}{dT} = \frac{V_{OUT}}{C_{OUT} \times 80k\Omega \parallel (R_1 + R_2) \parallel R_{LOAD}} \quad (5)$$

## REVERSE CURRENT

The NMOS pass element of the TPS7A37xx provides inherent protection against current flow from the output of the regulator to the input when the gate of the pass device is pulled low. To ensure that all charge is removed from the gate of the pass element, the EN pin must be driven low before the input voltage is removed. If this is not done, the pass element may be left on because of stored charge on the gate.

After the EN pin is driven low, no bias voltage is needed on any pin for reverse current blocking. Note that reverse current is specified as the current flowing out of the IN pin because of voltage applied on the OUT pin. There will be additional current flowing into the OUT pin as a result of the 80-k $\Omega$  internal resistor divider to ground (see [Figure 1](#) and [Figure 2](#)).

For the TPS7A3701, reverse current may flow when  $V_{FB}$  is more than 1.0 V above  $V_{IN}$ .

## THERMAL PROTECTION

Thermal protection disables the output when the junction temperature rises to approximately +160°C, allowing the device to cool. When the junction temperature cools to approximately +140°C, the output circuitry is again enabled. Depending on power dissipation, thermal resistance, and ambient temperature, the thermal protection circuit may cycle on and off. This cycling limits the dissipation of the regulator, protecting it from damage due to overheating.

Any tendency to activate the thermal protection circuit indicates excessive power dissipation or an inadequate heatsink. For reliable operation, junction temperature should be limited to +125°C maximum. To estimate the margin of safety in a complete design (including heatsink), increase the ambient temperature until the thermal protection is triggered; use worst-case loads and signal conditions. For good reliability, thermal protection should trigger at least +35°C above the maximum expected ambient condition of your application. This produces a worst-case junction temperature of +125°C at the highest expected ambient temperature and worst-case load.

The internal protection circuitry of the TPS7A37xx has been designed to protect against overload conditions. It was not intended to replace proper heatsinking. Continuously running the TPS7A37xx into thermal shutdown degrades device reliability.

## POWER DISSIPATION

Knowing the device power dissipation and proper sizing of the thermal plane that is connected to the tab or pad is critical to avoiding thermal shutdown and ensuring reliable operation.

Power dissipation of the device depends on input voltage and load conditions and can be calculated using [Equation 6](#):

$$P_D = (V_{IN} - V_{OUT}) \times I_{OUT} \quad (6)$$

Power dissipation can be minimized and greater efficiency can be achieved by using the lowest possible input voltage necessary to achieve the required output voltage regulation.

On both SON (DRB) and SON (DRV) packages, the primary conduction path for heat is through the exposed pad to the printed circuit board (PCB). The pad can be connected to ground or be left floating; however, it should be attached to an appropriate amount of copper PCB area to ensure the device does not overheat. On the SOT-223 (DCQ) package, the primary conduction path for heat is through the tab to the PCB. That tab should be connected to ground. The maximum junction-to-ambient thermal resistance depends on the maximum ambient temperature, maximum device junction temperature, and power dissipation of the device and can be calculated using [Equation 7](#):

$$R_{\theta JA} = \frac{(+125^{\circ}\text{C} - T_A)}{P_D} \quad (7)$$

Knowing the maximum  $R_{\theta JA}$ , the minimum amount of PCB copper area needed for appropriate heatsinking can be estimated using [Figure 33](#).

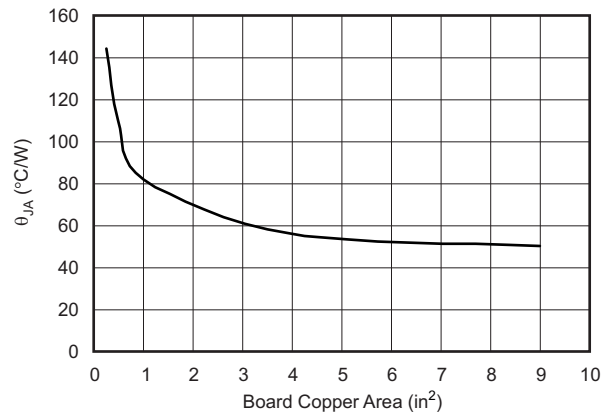

Note:  $\theta_{JA}$  value at board size of  $9\text{in}^2$  (that is,  $3\text{in} \times 3\text{in}$ ) is a JEDEC standard.

**Figure 33. DRV (SON) Package  $\theta_{JA}$  vs Board Size**

[Figure 33](#) shows the variation of  $\theta_{JA}$  as a function of ground plane copper area in the board. It is intended only as a guideline to demonstrate the effects of heat spreading in the ground plane and should not be used to estimate actual thermal performance in real application environments.

**NOTE:** When the device is mounted on an application PCB, it is strongly recommended to use  $\Psi_{JT}$  and  $\Psi_{JB}$ , as explained in the [Estimating Junction Temperature](#) section.

## ESTIMATING JUNCTION TEMPERATURE

Using the thermal metrics  $\Psi_{JT}$  and  $\Psi_{JB}$ , as shown in the *Thermal Information* table, the junction temperature can be estimated with corresponding formulas (given in Equation 8). For backwards compatibility, an older  $\theta_{JC, Top}$  parameter is listed as well.

$$\Psi_{JT}: T_J = T_T + \Psi_{JT} \cdot P_D$$

$$\Psi_{JB}: T_J = T_B + \Psi_{JB} \cdot P_D \tag{8}$$

Where  $P_D$  is the power dissipation shown by Equation 6,  $T_T$  is the temperature at the center-top of the IC package, and  $T_B$  is the PCB temperature measured 1mm away from the IC package *on the PCB surface* (as Figure 35 shows).

**NOTE:** Both  $T_T$  and  $T_B$  can be measured on actual application boards using a thermo-gun (an infrared thermometer).

For more information about measuring  $T_T$  and  $T_B$ , see the application note [SBVA025, Using New Thermal Metrics](#), available for download at [www.ti.com](#).

By looking at Figure 34, the new thermal metrics ( $\Psi_{JT}$  and  $\Psi_{JB}$ ) have very little dependency on board size. That is, using  $\Psi_{JT}$  or  $\Psi_{JB}$  with Equation 8 is a good way to estimate  $T_J$  by simply measuring  $T_T$  or  $T_B$ , regardless of the application board size.

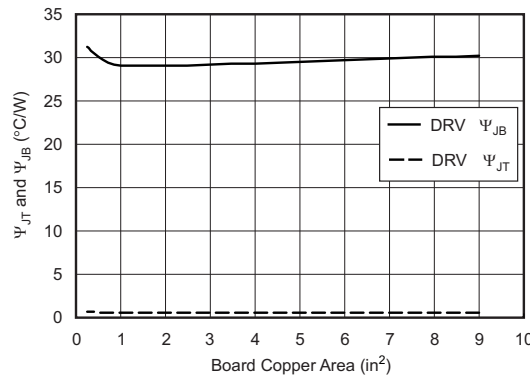
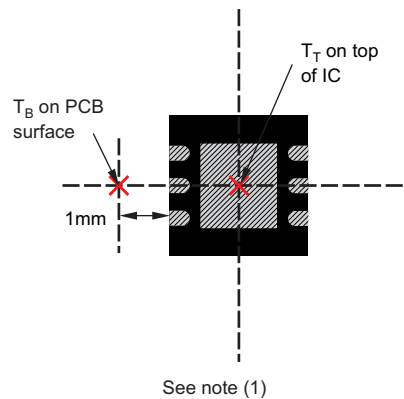

Figure 34. DRV (SON) Package  $\Psi_{JT}$  and  $\Psi_{JB}$  vs Board Size

For a more detailed discussion of why TI does not recommend using  $\theta_{JC(top)}$  to determine thermal characteristics, refer to application report [SBVA025, Using New Thermal Metrics](#), available for download at [www.ti.com](#). For further information, refer to application report [SPRA953, IC Package Thermal Metrics](#), also available on the TI website.



Example DRV (SON) Package Measurement

(1) Power dissipation may limit operating range. Check [Thermal Information](#) table.

Figure 35. Measuring Points for  $T_T$  and  $T_B$





### REVISION HISTORY

NOTE: Page numbers for previous revisions may differ from page numbers in the current version.

<b>Changes from Original (March 2013) to Revision A</b>	<b>Page</b>
• Changed device status to Production Data .....	<a href="#">1</a>

**PACKAGING INFORMATION**

Orderable Device	Status (1)	Package Type	Package Drawing	Pins	Package Qty	Eco Plan (2)	Lead/Ball Finish (6)	MSL Peak Temp (3)	Op Temp (°C)	Device Marking (4/5)	Samples
TPS7A3701DRVR	ACTIVE	SON	DRV	6	3000	Green (RoHS & no Sb/Br)	CU NIPDAU	Level-2-260C-1 YEAR	-40 to 125	SJI	<a href="#">Samples</a>
TPS7A3701DRVT	ACTIVE	SON	DRV	6	250	Green (RoHS & no Sb/Br)	CU NIPDAU	Level-2-260C-1 YEAR	-40 to 125	SJI	<a href="#">Samples</a>
TPS7A3721DRVR	ACTIVE	SON	DRV	6	3000	Green (RoHS & no Sb/Br)	CU NIPDAU	Level-2-260C-1 YEAR	-40 to 125	SIX	<a href="#">Samples</a>
TPS7A3721DRVT	ACTIVE	SON	DRV	6	250	Green (RoHS & no Sb/Br)	CU NIPDAU	Level-2-260C-1 YEAR	-40 to 125	SIX	<a href="#">Samples</a>
TPS7A3725DRVR	ACTIVE	SON	DRV	6	3000	Green (RoHS & no Sb/Br)	CU NIPDAU	Level-2-260C-1 YEAR	-40 to 125	SJH	<a href="#">Samples</a>
TPS7A3725DRVT	ACTIVE	SON	DRV	6	250	Green (RoHS & no Sb/Br)	CU NIPDAU	Level-2-260C-1 YEAR	-40 to 125	SJH	<a href="#">Samples</a>

(1) The marketing status values are defined as follows:

**ACTIVE:** Product device recommended for new designs.

**LIFEBUY:** TI has announced that the device will be discontinued, and a lifetime-buy period is in effect.

**NRND:** Not recommended for new designs. Device is in production to support existing customers, but TI does not recommend using this part in a new design.

**PREVIEW:** Device has been announced but is not in production. Samples may or may not be available.

**OBSOLETE:** TI has discontinued the production of the device.

(2) Eco Plan - The planned eco-friendly classification: Pb-Free (RoHS), Pb-Free (RoHS Exempt), or Green (RoHS & no Sb/Br) - please check <http://www.ti.com/productcontent> for the latest availability information and additional product content details.

**TBD:** The Pb-Free/Green conversion plan has not been defined.

**Pb-Free (RoHS):** TI's terms "Lead-Free" or "Pb-Free" mean semiconductor products that are compatible with the current RoHS requirements for all 6 substances, including the requirement that lead not exceed 0.1% by weight in homogeneous materials. Where designed to be soldered at high temperatures, TI Pb-Free products are suitable for use in specified lead-free processes.

**Pb-Free (RoHS Exempt):** This component has a RoHS exemption for either 1) lead-based flip-chip solder bumps used between the die and package, or 2) lead-based die adhesive used between the die and leadframe. The component is otherwise considered Pb-Free (RoHS compatible) as defined above.

**Green (RoHS & no Sb/Br):** TI defines "Green" to mean Pb-Free (RoHS compatible), and free of Bromine (Br) and Antimony (Sb) based flame retardants (Br or Sb do not exceed 0.1% by weight in homogeneous material)

(3) MSL, Peak Temp. - The Moisture Sensitivity Level rating according to the JEDEC industry standard classifications, and peak solder temperature.

(4) There may be additional marking, which relates to the logo, the lot trace code information, or the environmental category on the device.

(5) Multiple Device Markings will be inside parentheses. Only one Device Marking contained in parentheses and separated by a "~" will appear on a device. If a line is indented then it is a continuation of the previous line and the two combined represent the entire Device Marking for that device.

<sup>(6)</sup> Lead/Ball Finish - Orderable Devices may have multiple material finish options. Finish options are separated by a vertical ruled line. Lead/Ball Finish values may wrap to two lines if the finish value exceeds the maximum column width.

**Important Information and Disclaimer:** The information provided on this page represents TI's knowledge and belief as of the date that it is provided. TI bases its knowledge and belief on information provided by third parties, and makes no representation or warranty as to the accuracy of such information. Efforts are underway to better integrate information from third parties. TI has taken and continues to take reasonable steps to provide representative and accurate information but may not have conducted destructive testing or chemical analysis on incoming materials and chemicals. TI and TI suppliers consider certain information to be proprietary, and thus CAS numbers and other limited information may not be available for release.

In no event shall TI's liability arising out of such information exceed the total purchase price of the TI part(s) at issue in this document sold by TI to Customer on an annual basis.

## TAPE AND REEL INFORMATION



### QUADRANT ASSIGNMENTS FOR PIN 1 ORIENTATION IN TAPE



\*All dimensions are nominal

Device	Package Type	Package Drawing	Pins	SPQ	Reel Diameter (mm)	Reel Width W1 (mm)	A0 (mm)	B0 (mm)	K0 (mm)	P1 (mm)	W (mm)	Pin1 Quadrant
TPS7A3701DRVR	SON	DRV	6	3000	179.0	8.4	2.2	2.2	1.2	4.0	8.0	Q2
TPS7A3701DRVT	SON	DRV	6	250	179.0	8.4	2.2	2.2	1.2	4.0	8.0	Q2
TPS7A3721DRVR	SON	DRV	6	3000	179.0	8.4	2.2	2.2	1.2	4.0	8.0	Q2
TPS7A3721DRVT	SON	DRV	6	250	179.0	8.4	2.2	2.2	1.2	4.0	8.0	Q2
TPS7A3725DRVR	SON	DRV	6	3000	179.0	8.4	2.2	2.2	1.2	4.0	8.0	Q2
TPS7A3725DRVT	SON	DRV	6	250	179.0	8.4	2.2	2.2	1.2	4.0	8.0	Q2

**TAPE AND REEL BOX DIMENSIONS**



\*All dimensions are nominal

Device	Package Type	Package Drawing	Pins	SPQ	Length (mm)	Width (mm)	Height (mm)
TPS7A3701DRVR	SON	DRV	6	3000	195.0	200.0	45.0
TPS7A3701DRVT	SON	DRV	6	250	195.0	200.0	45.0
TPS7A3721DRVR	SON	DRV	6	3000	195.0	200.0	45.0
TPS7A3721DRVT	SON	DRV	6	250	195.0	200.0	45.0
TPS7A3725DRVR	SON	DRV	6	3000	195.0	200.0	45.0
TPS7A3725DRVT	SON	DRV	6	250	195.0	200.0	45.0

# MECHANICAL DATA

DRV (S-PWSON-N6)

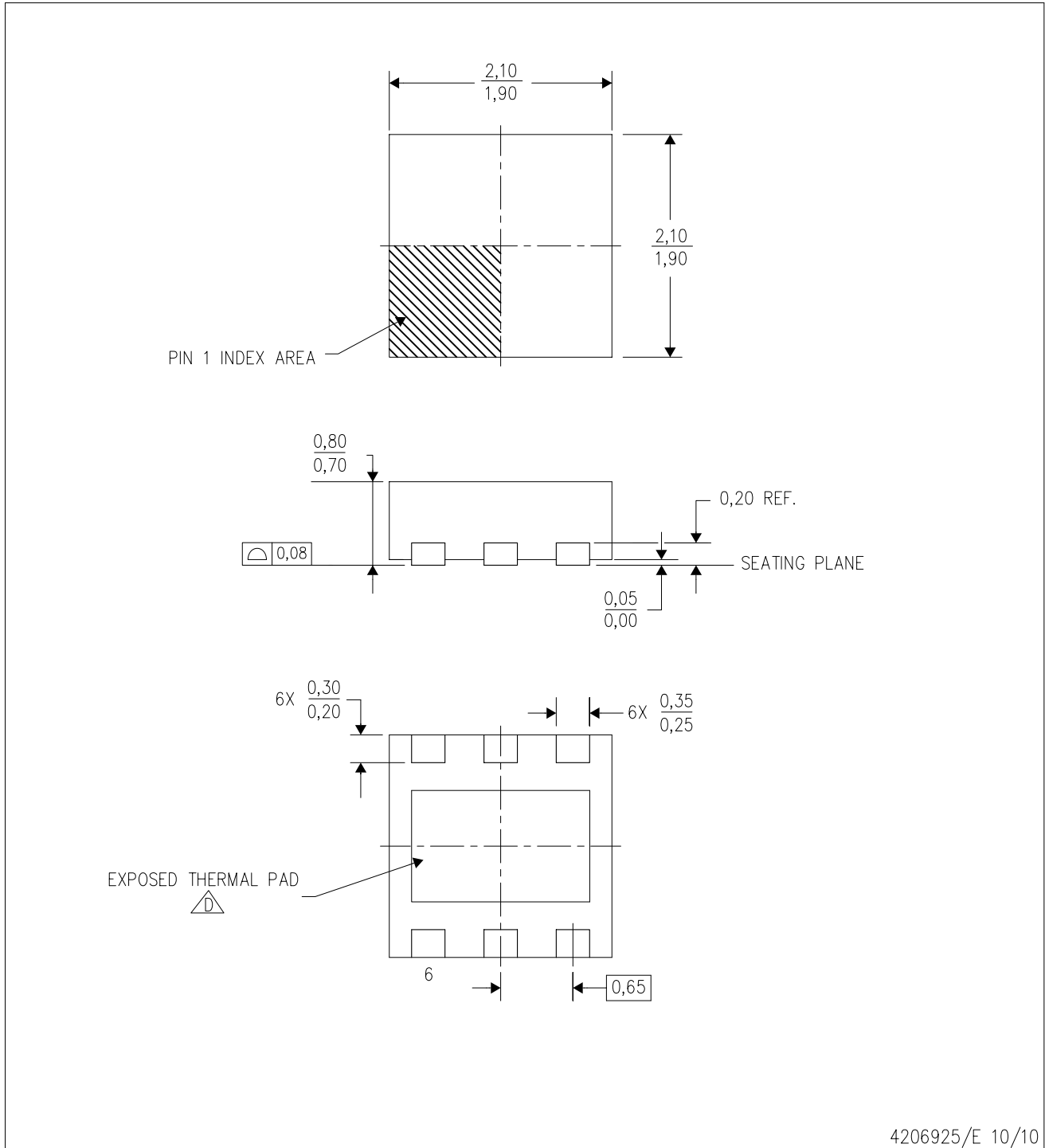
PLASTIC SMALL OUTLINE NO-LEAD



4206925/E 10/10

- NOTES:
- All linear dimensions are in millimeters. Dimensioning and tolerancing per ASME Y14.5M-1994.
  - This drawing is subject to change without notice.
  - Small Outline No-Lead (SON) package configuration.
-  The package thermal pad must be soldered to the board for thermal and mechanical performance. See the Product Data Sheet for details regarding the exposed thermal pad dimensions.

## THERMAL PAD MECHANICAL DATA

DRV (S-PWSON-N6)

PLASTIC SMALL OUTLINE NO-LEAD

### THERMAL INFORMATION

This package incorporates an exposed thermal pad that is designed to be attached directly to an external heatsink. The thermal pad must be soldered directly to the printed circuit board (PCB). After soldering, the PCB can be used as a heatsink. In addition, through the use of thermal vias, the thermal pad can be attached directly to the appropriate copper plane shown in the electrical schematic for the device, or alternatively, can be attached to a special heatsink structure designed into the PCB. This design optimizes the heat transfer from the integrated circuit (IC).

For information on the Quad Flatpack No-Lead (QFN) package and its advantages, refer to Application Report, QFN/SON PCB Attachment, Texas Instruments Literature No. SLUA271. This document is available at [www.ti.com](http://www.ti.com).

The exposed thermal pad dimensions for this package are shown in the following illustration.

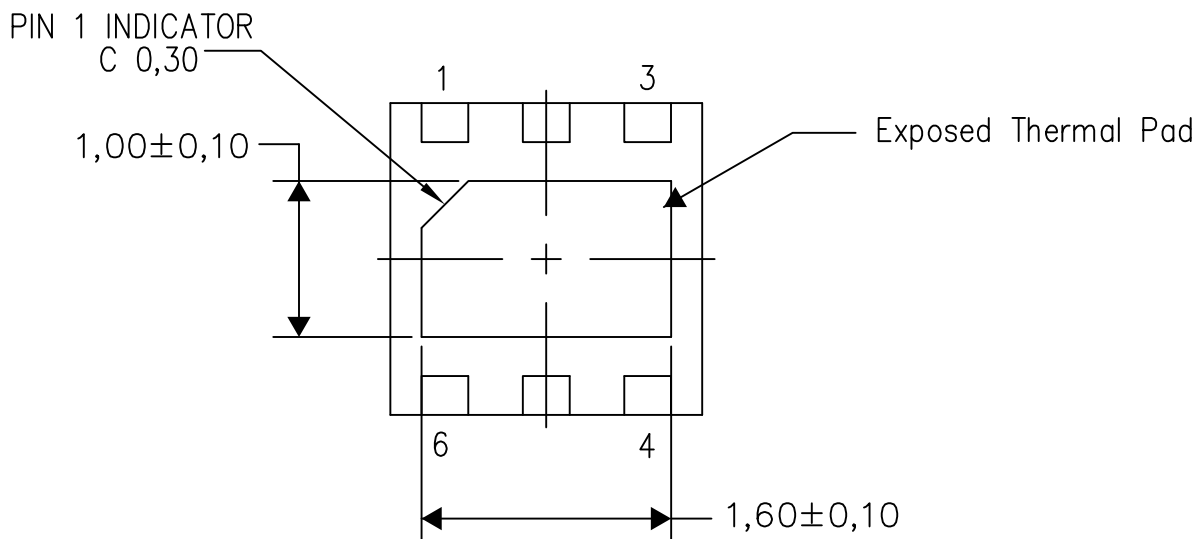

Bottom View

Exposed Thermal Pad Dimensions

4206926/0 01/14

NOTE: All linear dimensions are in millimeters



DRV (S-PWSON-N6)

PLASTIC SMALL OUTLINE NO-LEAD

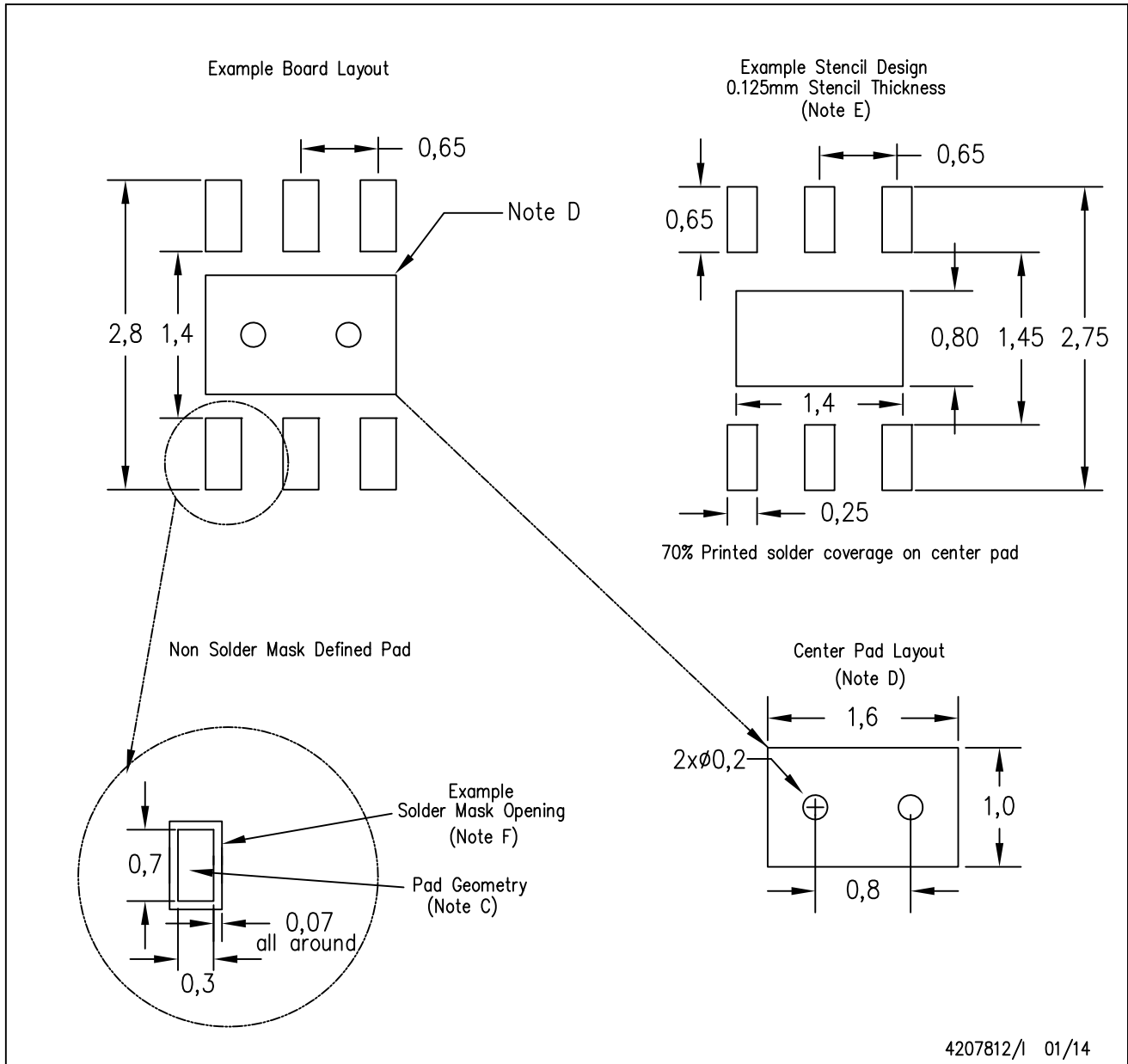

- NOTES:
- A. All linear dimensions are in millimeters.
  - B. This drawing is subject to change without notice.
  - C. Publication IPC-7351 is recommended for alternate designs.
  - D. This package is designed to be soldered to a thermal pad on the board. Refer to Application Note, QFN/SON PCB Attachment, Texas Instruments Literature No. SLUA271, and also the Product Data Sheets for specific thermal information, via requirements, and recommended board layout. These documents are available at [www.ti.com](http://www.ti.com) <<http://www.ti.com>>.
  - E. Laser cutting apertures with trapezoidal walls and also rounding corners will offer better paste release. Customers should contact their board assembly site for stencil design recommendations. Refer to IPC 7525 for stencil design considerations.
  - F. Customers should contact their board fabrication site for solder mask tolerances.

## IMPORTANT NOTICE

Texas Instruments Incorporated and its subsidiaries (TI) reserve the right to make corrections, enhancements, improvements and other changes to its semiconductor products and services per JESD46, latest issue, and to discontinue any product or service per JESD48, latest issue. Buyers should obtain the latest relevant information before placing orders and should verify that such information is current and complete. All semiconductor products (also referred to herein as "components") are sold subject to TI's terms and conditions of sale supplied at the time of order acknowledgment.

TI warrants performance of its components to the specifications applicable at the time of sale, in accordance with the warranty in TI's terms and conditions of sale of semiconductor products. Testing and other quality control techniques are used to the extent TI deems necessary to support this warranty. Except where mandated by applicable law, testing of all parameters of each component is not necessarily performed.

TI assumes no liability for applications assistance or the design of Buyers' products. Buyers are responsible for their products and applications using TI components. To minimize the risks associated with Buyers' products and applications, Buyers should provide adequate design and operating safeguards.

TI does not warrant or represent that any license, either express or implied, is granted under any patent right, copyright, mask work right, or other intellectual property right relating to any combination, machine, or process in which TI components or services are used. Information published by TI regarding third-party products or services does not constitute a license to use such products or services or a warranty or endorsement thereof. Use of such information may require a license from a third party under the patents or other intellectual property of the third party, or a license from TI under the patents or other intellectual property of TI.

Reproduction of significant portions of TI information in TI data books or data sheets is permissible only if reproduction is without alteration and is accompanied by all associated warranties, conditions, limitations, and notices. TI is not responsible or liable for such altered documentation. Information of third parties may be subject to additional restrictions.

Resale of TI components or services with statements different from or beyond the parameters stated by TI for that component or service voids all express and any implied warranties for the associated TI component or service and is an unfair and deceptive business practice. TI is not responsible or liable for any such statements.

Buyer acknowledges and agrees that it is solely responsible for compliance with all legal, regulatory and safety-related requirements concerning its products, and any use of TI components in its applications, notwithstanding any applications-related information or support that may be provided by TI. Buyer represents and agrees that it has all the necessary expertise to create and implement safeguards which anticipate dangerous consequences of failures, monitor failures and their consequences, lessen the likelihood of failures that might cause harm and take appropriate remedial actions. Buyer will fully indemnify TI and its representatives against any damages arising out of the use of any TI components in safety-critical applications.

In some cases, TI components may be promoted specifically to facilitate safety-related applications. With such components, TI's goal is to help enable customers to design and create their own end-product solutions that meet applicable functional safety standards and requirements. Nonetheless, such components are subject to these terms.

No TI components are authorized for use in FDA Class III (or similar life-critical medical equipment) unless authorized officers of the parties have executed a special agreement specifically governing such use.

Only those TI components which TI has specifically designated as military grade or "enhanced plastic" are designed and intended for use in military/aerospace applications or environments. Buyer acknowledges and agrees that any military or aerospace use of TI components which have **not** been so designated is solely at the Buyer's risk, and that Buyer is solely responsible for compliance with all legal and regulatory requirements in connection with such use.

TI has specifically designated certain components as meeting ISO/TS16949 requirements, mainly for automotive use. In any case of use of non-designated products, TI will not be responsible for any failure to meet ISO/TS16949.

### Products

Audio	<a href="http://www.ti.com/audio">www.ti.com/audio</a>
Amplifiers	<a href="http://amplifier.ti.com">amplifier.ti.com</a>
Data Converters	<a href="http://dataconverter.ti.com">dataconverter.ti.com</a>
DLP® Products	<a href="http://www.dlp.com">www.dlp.com</a>
DSP	<a href="http://dsp.ti.com">dsp.ti.com</a>
Clocks and Timers	<a href="http://www.ti.com/clocks">www.ti.com/clocks</a>
Interface	<a href="http://interface.ti.com">interface.ti.com</a>
Logic	<a href="http://logic.ti.com">logic.ti.com</a>
Power Mgmt	<a href="http://power.ti.com">power.ti.com</a>
Microcontrollers	<a href="http://microcontroller.ti.com">microcontroller.ti.com</a>
RFID	<a href="http://www.ti-rfid.com">www.ti-rfid.com</a>
OMAP Applications Processors	<a href="http://www.ti.com/omap">www.ti.com/omap</a>
Wireless Connectivity	<a href="http://www.ti.com/wirelessconnectivity">www.ti.com/wirelessconnectivity</a>

### Applications

Automotive and Transportation	<a href="http://www.ti.com/automotive">www.ti.com/automotive</a>
Communications and Telecom	<a href="http://www.ti.com/communications">www.ti.com/communications</a>
Computers and Peripherals	<a href="http://www.ti.com/computers">www.ti.com/computers</a>
Consumer Electronics	<a href="http://www.ti.com/consumer-apps">www.ti.com/consumer-apps</a>
Energy and Lighting	<a href="http://www.ti.com/energy">www.ti.com/energy</a>
Industrial	<a href="http://www.ti.com/industrial">www.ti.com/industrial</a>
Medical	<a href="http://www.ti.com/medical">www.ti.com/medical</a>
Security	<a href="http://www.ti.com/security">www.ti.com/security</a>
Space, Avionics and Defense	<a href="http://www.ti.com/space-avionics-defense">www.ti.com/space-avionics-defense</a>
Video and Imaging	<a href="http://www.ti.com/video">www.ti.com/video</a>

### TI E2E Community

[e2e.ti.com](http://e2e.ti.com)

# Mouser Electronics

Authorized Distributor

Click to View Pricing, Inventory, Delivery & Lifecycle Information:

[Texas Instruments:](#)

[TPS7A3701DRVR](#) [TPS7A3701DRVT](#)