

GNS-5612Ax-Bx (SINGLE DIGIT LED DISPLAY)

GNS-5612 Series

GNS-5612Ax

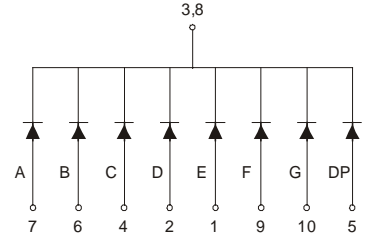
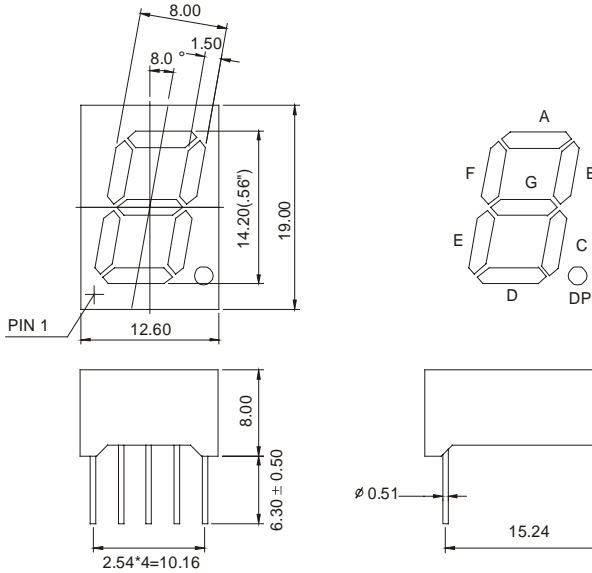

GNS-5612Bx

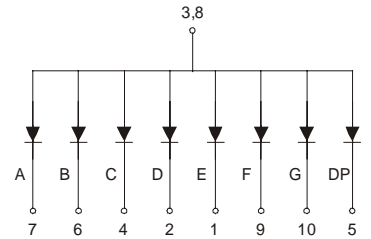

Features:

*0.56 INCH HIGH CHARACTER.

*EXCELLENT CHARACTER APPEARANCE.

*COMMON CATHODE OR COMMON ANODE.

*I.C. COMPATIBLE.

*LOW POWER CONSUMPTION.

Part Number	EMITTED COLOR		Common Cathode or Common Anode	Peak Wavelength (nm)	Vf (v) Typ	If (mA)	Intensity Per Segment (mcd)	
							Min.	Typ.
GNS-5612AE	GaAsP/GaP	Hi.effi Red	Common Cathode	635	2.0	20	9	12
GNS-5612AG	GaP	Green		565	2.1	20	8	11
GNS-5612AY	GaAsP/GaP	Yellow		585	2.0	20	9	12
GNS-5612AS	GaAlAs	Super Red		660	1.8	20	10	13
GNS-5612AD	GaAlAs	Ultra Red		660	1.8	20	25	30
GNS-5612AUE	AlGaInP	Ultra Red		625	2.0	20	30	35
GNS-5612AUY	AlGaInP	Ultra Yellow		590	2.0	20	30	35
GNS-5612BE	GaAsP/GaP	Hi.effi Red	Common Anode	635	2.0	20	9	12
GNS-5612BG	GaP	Green		565	2.1	20	8	11
GNS-5612BY	GaAsP/GaP	Yellow		585	2.0	20	9	12
GNS-5612BS	GaAlAs	Super Red		660	1.8	20	10	13
GNS-5612BD	GaAlAs	Ultra Red		660	1.8	20	25	30
GNS-5612BUE	AlGaInP	Ultra Red		625	2.0	20	30	35
GNS-5612BUY	AlGaInP	Ultra Yellow		590	2.0	20	30	35