

Features

- RoHS lead-free-solder and lead-solder-exempted products are available.
- Input voltage ranges up to 121 VDC
- 1 or 2 isolated outputs up to 48 V
- Extremely wide input voltage ranges
- Immunity according to IEC/EN 61000-4-2, -3, -4, -5, -6
- High efficiency (typ. 83%)
- Flexible load distribution on outputs
- Outputs no-load, overload, and short-circuit proof
- High reliability
- Operating ambient temperature –40 to +85 °C
- Thermal protection
- Industrial and alternative pinout
- DIL 24 case with 8.5 mm profile

Safety-approved to IEC 60950-1 2nd Ed and CSA/UL 60950-1 2nd Ed.



Description

The IMX4 Series of board-mountable, 4-watt DC-DC converters has been designed according to the latest industry requirements and standards. The converters are particularly suitable for use in mobile or stationary applications in transport, industry, or telecom, where variable input voltages or high transient voltages are prevalent.

Covering a total input voltage range from 8.4 VDC up to 121 VDC with three different models, the converters are available with single and dual outputs from 3.3 up to ±24 VDC with flexible load distribution. Features include efficient input and output filtering with unsurpassed transient and surge protection, low output ripple and noise, consistently high efficiency over the entire input voltage range and high reliability as well as excellent dynamic response to load and line changes.

The converters exhibit basic insulation and are designed and built according to the international safety standards IEC/EN

60950-1 2nd Ed. 70IMX4 models are CE-marked.

A special feature is their small case size, DIL 24 with only 8.5 mm profile. The circuit is comprised of integrated planar magnetics, and all components are automatically assembled and solidly soldered onto a single PCB without any wire connection. Thanks to the rigid mechanical design, the converters withstand an extremely high level of shock and vibrations. Careful considerations of possible thermal stresses ensure the absence of hot spots providing long life in environments where temperature cycles are a reality. The thermal design allows operation at full load up to an ambient temperature of 85 °C in free air without using any potting material.

Several options, such as open-frame or an alternative industrial pinout, provide a high level of application-specific engineering and design-in flexibility.

Table of Contents

Table of Contents	Page	Page	
Description	1	Electromagnetic Compatibility (EMC)	8
Model Selection	2	Mechanical Data	9
Functional Description	3	Immunity to Environmental Conditions	10
Electrical Input Data	4	Safety and Installation Instructions	10
Electrical Output Data	6	Description of Options	11

Model Selection

Table 1: Model Selection

Output 1		Output 2		Output power $P_{o\ nom}$ [W]	Input voltage range [VDC]	Efficiency		Model	Options ²
$V_{o1\ nom}$ [VDC]	$I_{o1\ nom}$ [mA] ¹	$V_{o2\ nom}$ [VDC]	$I_{o2\ nom}$ [mA] ¹			η_{min} [%]	η_{typ} [%]		
3.3	900	-	-	3.0	8.4 to 36	77.3	79	20IMX4-03-8	Z, G
3.3	900	-	-	3.0	16.8 to 75	77	80	40IMX4-03-8	Z, G
5	700	-	-	3.5	4.7 to 16.8	76	-	5IMX4-05-8	Z, G
5	700	-	-	3.5	8.4 to 36	78	81	20IMX4-05-8	K, Z, G
5	700	-	-	3.5	16.8 to 75	78	81	40IMX4-05-8	K, Z, G
5	700	-	-	3.5	40 to 121	75.5	78	70IMX4-05-8	G
12	300	-	-	3.6	4.7 to 16.8	79	-	5IMX4-12-8	Z, G
12	340	-	-	4.1	8.4 to 36	78	82	20IMX4-12-8	K, Z, G
12	340	-	-	4.1	16.8 to 75	78	82	40IMX4-12-8	K, Z, G
12	340	-	-	4.1	40 to 121	77	82	70IMX4-12-8	G
15	250	-	-	3.75	4.7 to 16.8	79	-	5IMX4-15-8	Z, G
15	280	-	-	4.2	8.4 to 36	78	82	20IMX4-15-8	K, Z, G
15	280	-	-	4.2	16.8 to 75	78.7	82	40IMX4-15-8	K, Z, G
15	280	-	-	4.2	40 to 121	77	82	70IMX4-15-8	G
+5	350	-5	350	3.5	8.4 to 36	77	81	20IMX4-0505-8	K, Z, G
+5	350	-5	350	3.5	16.8 to 75	76	81	40IMX4-0505-8	K, Z, G
+5	350	-5	350	3.5	40 to 121	75.5	78	70IMX4-0505-8	G
+12	170	-12	170	4.1	8.4 to 36	76	82	20IMX4-1212-8	K, Z, G
+12	170	-12	170	4.1	16.8 to 75	76	82	40IMX4-1212-8	K, Z, G
+15	140	-15	140	4.2	8.4 to 36	78	82	20IMX4-1515-8	K, Z, G
+15	140	-15	140	4.2	16.8 to 75	76	82	40IMX4-1515-8	K, Z, G
+24	80	-24	80	3.8	8.4 to 36	76	83	20IMX4-2424-8	Z, G
+24	80	-24	80	3.8	16.8 to 75	76	83	40IMX4-2424-8	Z, G

¹ Flexible load distribution on double-outputs possible

² For availability and lead times ask Power-One !

G Preferred for new designs.

Part Number Description

Input voltage range V_i

4.7 to 16.8 VDC 5
 8.4 to 36 VDC 20
 16.8 to 75 VDC 40
 40 to 121 VDC 70

Series IMX4

Output voltage of output 1 03, 05, 12, 15, 24

Output voltage of output 2 05, 12, 15, 24

Operating ambient temperature range -40 to 85 °C -8

Options: Alternative pinout K

Open frame Z

RoHS compliant for all six substances G¹

20 IMX4 - 05 05 - 8 K Z G

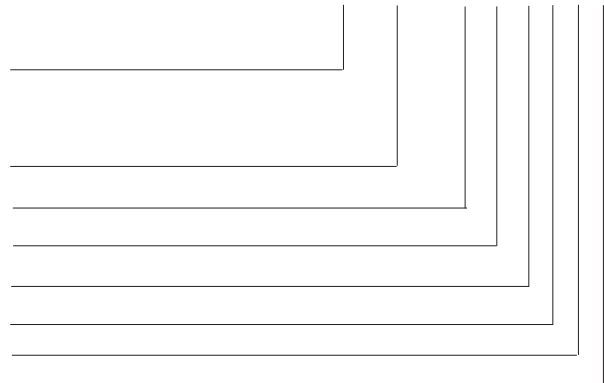

¹ G is always placed at the end of the part number. G is preferred for new designs.

Note: The sequence of options must follow the order above.

Example: 40IMX4-0505-8KG: DC-DC converter, input voltage range 16.8 to 75 V, 2 outputs providing ± 5 V, 350 mA, temperature range -40 to 85 °C, alternative pinout, RoHS-compliant for all six substances

Functional Description

The IMX4 Series converters are feedback-controlled flyback converters using current mode PWM (Pulse Width Modulation). The input is protected against transients by means of a suppressor diode.

The output voltage is monitored by a separate transformer winding and fed back to the control circuit.

Current limitation is provided by the primary circuit, thus limiting the total output current ($I_{o\ nom}$ for single- and the sum $I_{o1\ nom} + I_{o2\ nom}$ for dual-output models).

The close magnetic coupling provided by the planar construction ensures very good regulation and allows for flexible load distribution on dual-output models.

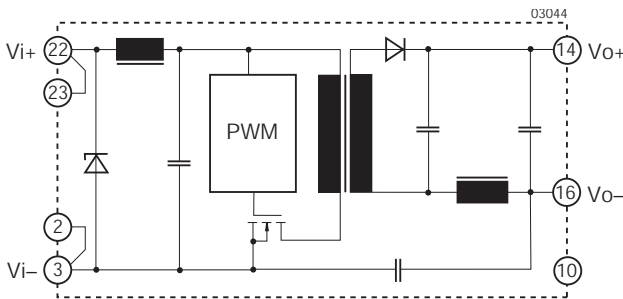

Fig. 1
Block diagram for single-output models with standard pinout.

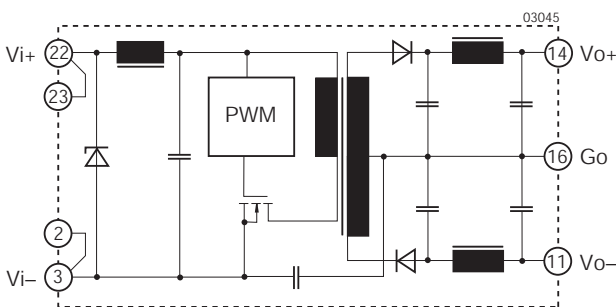

Fig. 2
Block diagram for dual-output models with standard pinout.

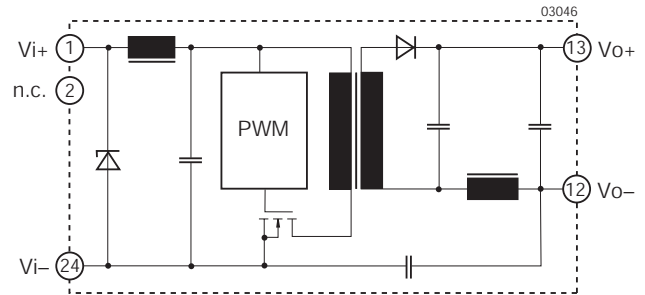

Fig. 3
Block diagram for single-output models with alternative pinout (option K).

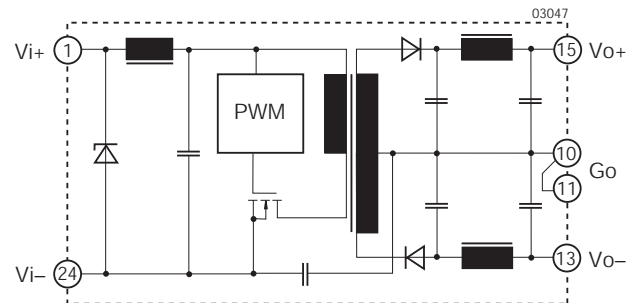

Fig. 4
Block diagram for dual-output models with alternative pinout (option K).

Electrical Input Data

General conditions: $T_A = 25\text{ }^\circ\text{C}$, unless T_C is specified.

Table 2: Input Data

Input			5IMX4			20IMX4			40IMX4			70IMX4			Unit
Characteristics		Conditions	min	typ	max	min	typ	max	min	typ	max	min	typ	max	
V_i	Input voltage range	$T_C \text{ min to } T_C \text{ max}$	4.7	5.0	16.8	8.4	36		16.8 ²	75		40	121		VDC
$V_{i \text{ nom}}$	Nominal input voltage	$I_o = 0 \text{ to } I_o \text{ nom}$	5.0			20			40			70			
$V_{i \text{ sur}}$	Repetitive surge voltage	abs. max input (3 s)	--			40			100			150			
$t_{\text{start-up}}$	Converter start-up time ¹	Worst case condition at $V_{i \text{ min}}$ and full load	0.25	0.5		0.25	0.5		0.25	0.5		0.25	0.5		s
t_{rise}	Rise time ¹	$V_{i \text{ nom}}$ resistive load	--			5			5			5			ms
		$I_o \text{ nom}$ capacitive load	--			12			12			12			
$I_{i \text{ o}}$	No-load input current	$I_o = 0, V_{i \text{ min}} \text{ to } V_{i \text{ max}}$	--			15 20			5 10			5 10			mA
C_i	Input capacitance		--			0.54			0.3			0.15			μF
$I_{\text{inr p}}$	Inrush peak current	$V_i = V_{i \text{ nom}}^3$	3.8			3.7			4.2			5.6			A
f_s	Switching frequency	$V_{i \text{ min}} \text{ to } V_{i \text{ max}}, I_o = 0 \text{ to } I_o \text{ nom}$	400			400			400			400			kHz
$I_{i \text{ rr}}$	Reflected ripple current	$I_o = 0 \text{ to } I_o \text{ nom}$	--			100			60			30			mA_{pp}
$V_{i \text{ RFI}}$	Input RFI level conducted	EN 55011/55022 ⁴	--			A			A			A			Class

¹ Measured with a resistive or max. admissible capacitive load; see fig. 5

² Operation at lower input voltage possible: P_o approx. 80% of $P_{o \text{ nom}}$ at $V_{i \text{ min}} = 14.4\text{ V}$

³ Source impedance according to ETS 300132-2, version 4.3.

⁴ External capacitors required according to table 3.

Start-up

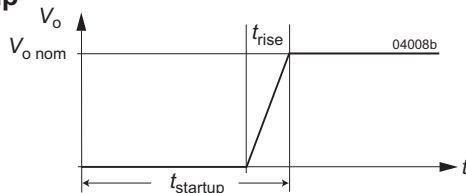

Fig. 5

Converter start-up and rise time

Inrush Current

The inrush current has been kept as low as possible by choosing a very small input capacitance. A series resistor may be inserted in the input line to further limit this current.

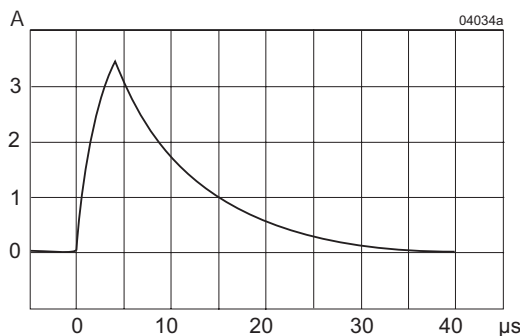

Fig. 6

Typ. inrush current at $V_{i \text{ nom}}, P_{o \text{ nom}}$ versus time measured according to ETS 300132-2, version 4.3 (40IMX4).

Filter to Comply with EN 55011/55022

Electromagnetic emission requirements according to table *Electrical Input Data* can be achieved by adding an external capacitor as close as possible to the input terminals (see fig. 7 and table 3).

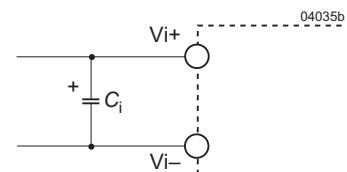

Fig. 7

Input capacitors

Table 3: Input electrolytic capacitors

Model	20IMX4	40IMX4	70IMX4
C_i	100 μF 50 V	47 μF 100 V	330 μF 200 V

Input Transient Voltage Protection

In many applications transient voltages on the converter input are always possible. These may be caused for example by short circuits between V_{i+} and V_{i-} , where the network inductance may generate high energy pulses.

In order to protect the converter, a transient voltage suppressor diode is fitted to the input; see table below.

Table 4: Built-in transient voltage suppressor

Model	Breakdown voltage $V_{BR\ nom}$	Peak power at 1 ms P_P	Peak pulse current I_{PP}
5IMX4	--	--	--
20IMX4	40 V	600 W	10.3 A
40IMX4	100 V	600 W	4.1 A
70IMX4	150 V	600 W	2.9 A

If transients generating currents above the peak pulse current I_{PP} are possible, an external limiting network such as the circuit shown in figure 8 is recommended. It provides compliance with transients according to IEC/EN 61000-4-5, level 2. The components are specified in table 5.

If 40IMX4 converters should withstand 150 V transients according to 19Pfl1, the same external circuitry with similar components as shown in figure 8 can be used.

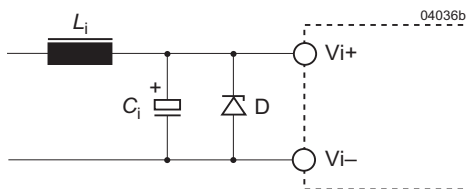

Fig. 8

External circuitry to comply with IEC/EN 61000-4-5, level 2.

Table 5: Components for the circuitry fig. 8

Model	20IMX4	40IMX4	70IMX4
L_i	330 μ H, 0.42 W 1 A	330 μ H, 0.42 W 0.6 A	330 μ H, 0.65 W 0.3 A
C_i	68 μ F, 50 V	68 μ F, 100 V	100 μ F, 200 V
D	ON 1.5KE 39 A	ON 1.5KE 82 A	—

Fuse and Reverse Polarity Protection

The suppressor diode on the input also protects against reverse polarity input voltage. An external fast fuse is required to limit this reverse current; see table below.

Table 6: External input fuse

Model	Fuse type
5IMX4	Fast 1.6 A
20IMX4	Fast 1 A
40IMX4	Fast 0.5 A
70IMX4	Fast 0.315 A

Electrical Output Data

General conditions: $T_A = 25\text{ }^\circ\text{C}$, unless T_C is specified.

Table 7a: Output data for single-output models

Output		$V_{o\text{nom}}$	3.3 V			5 V			12 V		15 V		Unit
Characteristics		Conditions	min	typ	max	min	typ	max	min	typ	max		
V_o	Output setting voltage	$V_{i\text{nom}}, I_o = 0.5 I_{o\text{nom}}$	3.27	3.33		4.96	5.04		11.90	12.10	14.88	15.12	V
$I_{o\text{nom}}$	Output current (nom.)	$V_{i\text{min}}$ to $V_{i\text{max}}$ 5IMX4	--			700			300		250		mA
		others	900			700			340		280		
I_{oL}	Current limit ²	$V_{i\text{nom}}$ 5IMX4	950			1000			375		325		
		others	1260	1800		955	1400		476	680	392	560	
ΔV_o	Line regulation	$V_{i\text{min}}$ to $V_{i\text{max}}, I_{o\text{nom}}$	± 1			± 1			± 1		± 1		%
ΔV	Load regulation	$V_{i\text{nom}}$ $I_o = (0.1 \text{ to } 1) I_{o\text{nom}}$	± 3.5			± 3			± 3		± 3		
v_o	Output voltage noise	$V_{i\text{min}}$ to $V_{i\text{max}}$ 5 $I_o = I_{o\text{nom}}$ 6	80			80			120		150		mV _{pp}
			20	40		20	40		40	60	50	75	
$V_{o\text{clp}}$	Output overvoltage limitation	Min. load 1%	130			130			130		130		%
$C_{o\text{ext}}$	Admissible capacitive load		0	680		0	680		0	150	0	100	μF
$v_{o\text{d}}$	Dynamic load regulat.	Voltage deviat.	± 250			± 250			± 250		± 250		mV
t_d		Recovery time	$V_{i\text{nom}}$ $I_o = (1 \text{ to } 0.5) I_{o\text{nom}}$	1			1			1		1	
α_{V_o}	Temperature coefficient $\Delta V_o/\Delta T_C$	$V_{i\text{min}}$ to $V_{i\text{max}}$ $I_o = (0.1 \text{ to } 1) I_{o\text{nom}}$	± 0.02			± 0.02			± 0.02		± 0.02		%/K

Table 7b: Output data for dual-output models

Output		$V_{o\text{nom}}$	$\pm 5\text{ V}$			$\pm 12\text{ V}$			$\pm 15\text{ V}$		$\pm 24\text{ V}$		Unit		
Characteristics		Conditions	min	typ	max	min	typ	max	min	typ	max	min	typ	max	
V_{o1} V_{o2}	Output setting voltage	$V_{i\text{nom}}$ $I_{o1} = I_{o2} = 0.5 I_{o\text{nom}}$	4.96	5.04		11.90	12.10		14.88	15.12	23.81	24.19		V	
			4.95	5.05		11.88	12.12		14.85	15.15	23.75	24.25			
$I_{o\text{nom}}$	Output current (nom.) ¹	$V_{i\text{min}}$ to $V_{i\text{max}}$	2 x 350			2 x 170			2 x 140		2 x 80		mA		
I_{oL}	Current limit ^{2 3}	$V_{i\text{nom}}, T_C = 25\text{ }^\circ\text{C}$	1000			474			392		232				
ΔV_o	Line regulation	$V_{i\text{min}}$ to $V_{i\text{max}}, I_{o\text{nom}}$	± 1			± 1			± 1		± 1		%		
ΔV	Load regulation ⁴	$V_{i\text{nom}}$ $I_o = (0.1 \text{ to } 1) I_{o\text{nom}}$	± 3			± 3.5			± 3		± 3				
$v_{o1,2}$	Output voltage noise	$V_{i\text{min}}$ to $V_{i\text{max}}$ 5 $I_o = I_{o\text{nom}}$ 6	100			140			150		240		mV _{pp}		
			40	60		45	70		50	75	40	120			
$V_{o\text{clp}}$	Output overvoltage limitation	Min. load 1%	130			130			130		130		%		
$C_{o\text{ext}}$	Admissible capacitive load ³		0	680		0	150		0	100	0	47	μF		
$v_{o\text{d}}$	Dynamic load regulat.	Voltage deviat.	± 250			± 600			± 750		± 750		mV		
t_d		Recovery time	$V_{i\text{nom}}$ $I_o = (1 \text{ to } 0.5) I_{o\text{nom}}$	1			1			1		1		ms	
α_{V_o}	Temperature coefficient $\Delta V_o/\Delta T_C$	$V_{i\text{min}}$ to $V_{i\text{max}}$ $I_o = (0.1 \text{ to } 1) I_{o\text{nom}}$	± 0.02			± 0.02			± 0.02		± 0.02		%/K		

¹ Each output is capable of delivering full output power.

² The current limit is primary side controlled.

³ Sum of both outputs

⁴ Conditions for specified output. Other output loaded with constant current $I_o = 0.5 I_{o\text{nom}}$.

⁵ BW = 20 MHz

⁶ Measured with a probe according to EN 61204

Thermal Considerations

If a converter, mounted on a PCB, is located in free, quasi-stationary air (convection cooling) at the maximum ambient temperature $T_{A \max}$ (see table *Temperature specifications*) and is operated at nominal input voltage and output power, the case temperature T_C measured at the measuring point of case temperature T_C (see *Mechanical Data*) will approach the indicated value $T_{C \max}$ after the warm-up phase. However, the relationship between T_A and T_C depends heavily on the conditions of operation and integration into a system. The thermal conditions depend on input voltage, output current, airflow, temperature of surrounding components and surfaces and the properties of the printed circuit board. $T_{A \max}$ is therefore only an indicative value, and under practical operating conditions, the ambient temperature T_A may be higher or lower.

Caution: The case temperature T_C measured at the measuring point of case temperature T_C (see *Mechanical Data*) may under no circumstances exceed the specified maximum. The installer must ensure that under all operating conditions T_C remains within the limits stated in the table *Temperature Specifications*.

Short Circuit Behavior

The current limitation shuts down the converter, when a short circuit is applied to the output. It acts self-protecting, and automatically recovers after removal of the overload condition.

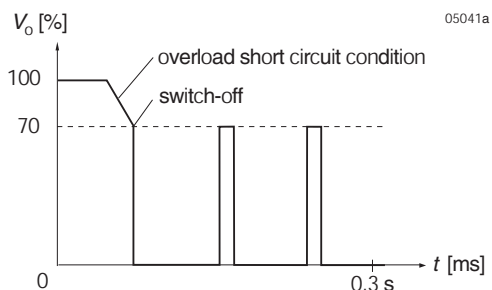

Fig. 9

Overload switch-off (hiccup mode).

Output Overvoltage Protection

The outputs are protected against overvoltages by Zener diodes. In the event of an overvoltage, the converter will shut-down and attempt to restart automatically. The main purpose of this feature is to protect against possible overvoltages, which could occur due to a failure in the feedback control circuit. The converters are not designed to withstand external overvoltages applied to the outputs.

Connection in Series

The outputs of single or dual-output models can be connected in series without any precautions, taking into consideration that the output voltage should remain below 60 V for SELV operation.

Connection in Parallel

Several converters with equal output voltage can be connected in parallel and will share their output current quite equally. However, this may cause start-up problems and is only recommended in applications, where one converter is able to deliver the full load current, e.g., in true redundant systems.

Typical Performance Curves

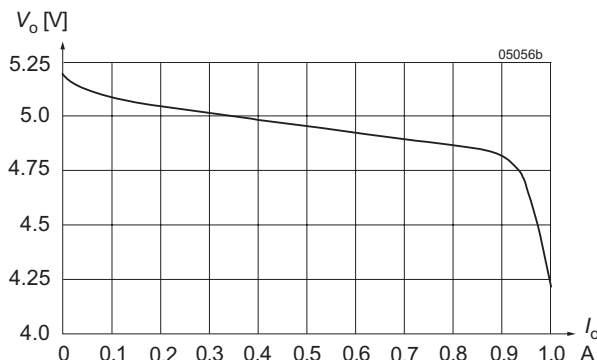

Fig. 10

V_o versus I_o (typ) of single-output models (20IMX4-05)

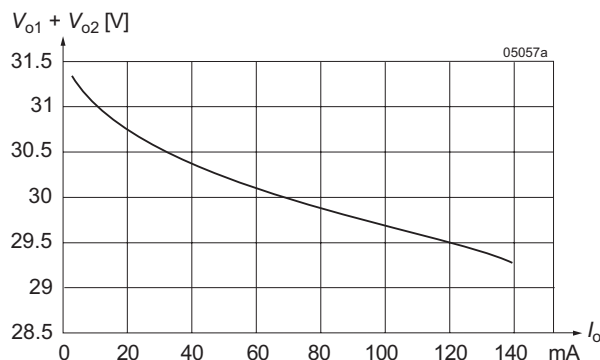

Fig. 11

V_o versus I_o (typ.) of dual-output models (± 15 V), with load connected between V_{o+} and V_{o-} .

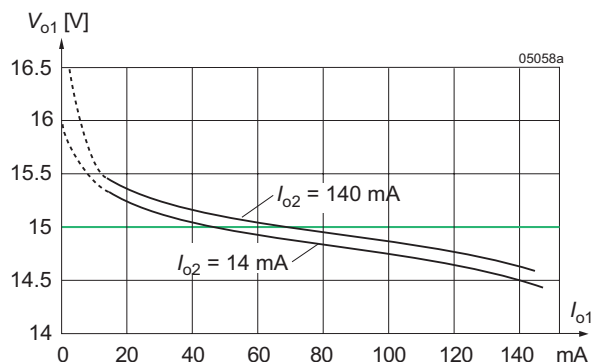

Fig. 12

Cross load regulation of dual-output models. V_{o1} versus I_{o1} (typ) for various I_{o2} (40IMX4-1515).

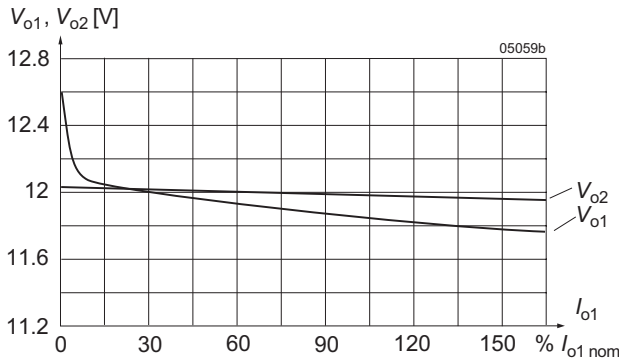

Fig. 13

Flexible load distribution on dual outputs ($2 \times 12\text{ V}$) with load variation from 0 to 150% of $P_{o1\text{ nom}}$ on output 1. Output 2 loaded with 25% of $P_{o2\text{ nom}}$.

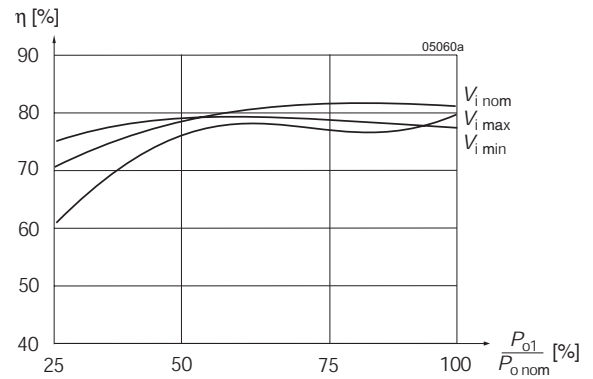

Fig. 14

Efficiency versus input voltage and load. Typical values (40IMX4-1212).

Electromagnetic Compatibility (EMC)

Electromagnetic Immunity

Table 8: Immunity type tests

Phenomenon	Standard	Class level	Coupling mode	Value applied	Waveform	Source imped.	Test procedure	In oper.	Per-form. ²
Electrostatic discharge to case	IEC/EN 61000-4-2	2	contact discharge	4000 V_p	1/50 ns	330 Ω	10 positive and 10 negative discharges	yes	B
		3	air discharge	8000 V_p					
Electromagnetic field	IEC/EN 61000-4-3	3 ³	antenna	10 V/m	AM 80% 1 kHz	n.a.	80 – 1000 MHz	yes	A
		3	antenna	10 V/m	PM, 50% duty cycle, 200 Hz repetition frequ.	n.a.	900 MHz	yes	A
Electrical fast transients/burst	IEC/EN 61000-4-4	4	direct +i/-i	$\pm 4000\text{ V}_p$	bursts of 5/50 ns 5 kHz repet. rate, 15 ms burst, 300 ms period	50 Ω	60 s positive 60 s negative coupling mode	yes	B
Surges	IEC/EN 61000-4-5	2 ⁴	+i/-i	1000 V_p	1.2/50 μs	2 Ω	5 pos. and 5 neg. surges	yes	B
RF conducted immunity	IEC/EN 61000-4-6	3	+i/-i	3 VAC (140 dB μV)	AM 80% 1 kHz	50 Ω	0.15 to 80 MHz 150 W	yes	A

¹ i = input, o = output

² Performance criterion: A = normal operation, no deviation from specifications, B = temporary loss of function or deviation from specs.

³ Corresponds to the railway standard EN 50121-3-2:2000, table 9.1

⁴ External components required.

Electromagnetic Emission

Conducted RFI noise at input according to EN 55011/55022

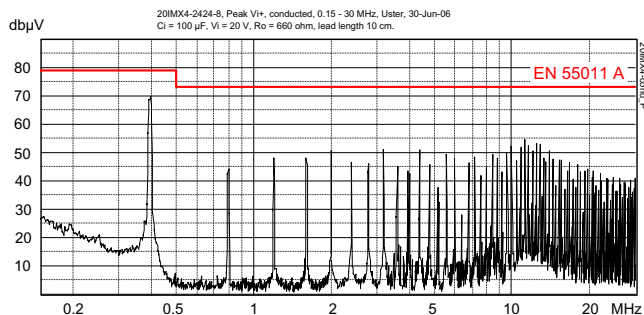

Fig. 15a

Typical disturbance voltage (peak) at the pos. input according to EN 55011/55022, measured at V_{i nom} and I_{o nom}.
Output leads 0.1 m, twisted. Input capacitors see table 3.
(20IMX4-2424-8).

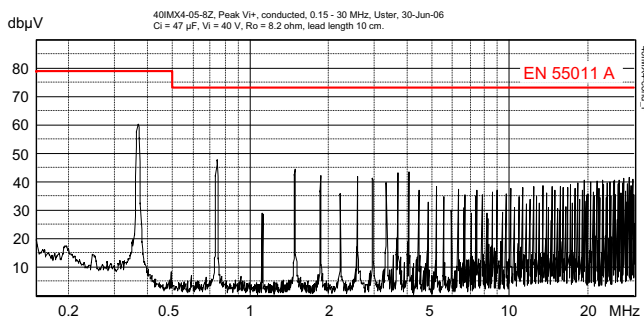

Fig. 15b

Typical disturbance voltage (peak) at the pos. input according to EN 55011/55022, measured at V_{i nom} and I_{o nom}.
Output leads 0.1 m, twisted. Input capacitors see table 3.
(40IMX4-05-8Z).

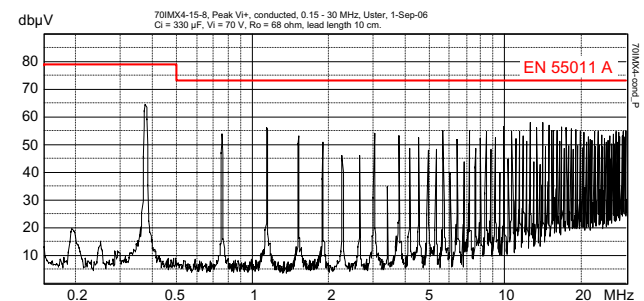

Fig. 15c

Typical disturbance voltage (peak) at the pos. input according to EN 55011/55022, measured at V_{i nom} and I_{o nom}.
Output leads 0.1 m, twisted. Input capacitors see table 3.
(70IMX4-15-8).

Mechanical Data

Dimensions in mm (inches).
Tolerances ±0.3 mm

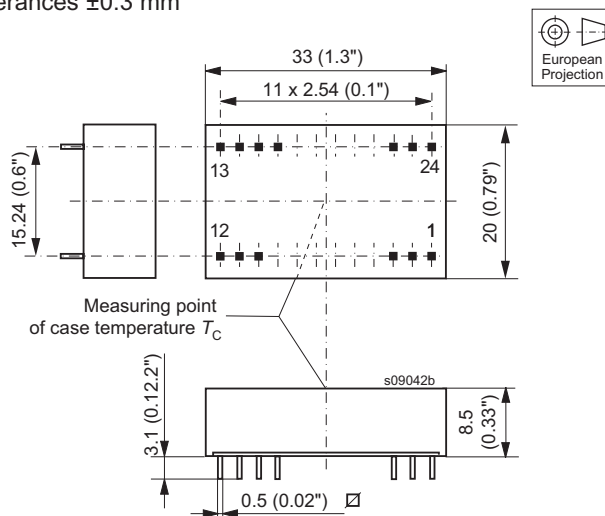

Fig. 16

Standard or alternative pinout (option K)

Weight: <10 g

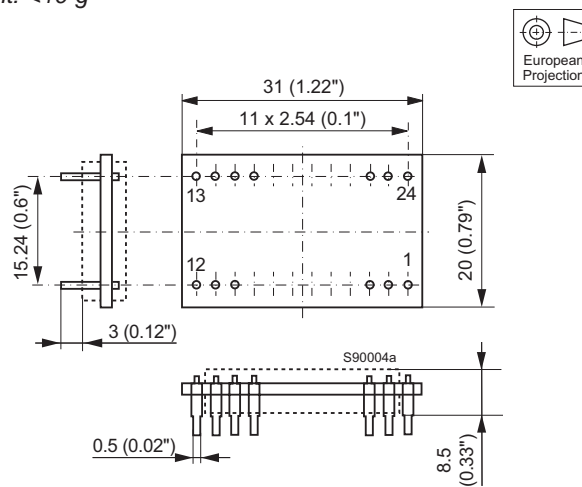

Fig. 17

Open frame (option Z)

Weight: <10 g

Immunity to Environmental Conditions

Table 9: Mechanical and climatic stress

Test Method		Standard	Test conditions		Status
Ca	Damp heat steady state	IEC/EN 60068-2-78 MIL-STD-810D section 507.2	Temperature: Relative humidity: Duration:	40 ±2 °C 93 ^{+2/-3} % 56 days	Converter not operating
Ea	Shock (half-sinusoidal)	IEC/EN 60068-2-27 ¹ MIL-STD-810D section 516.3	Acceleration amplitude: Bump duration: Number of bumps:	100 g _n = 981 m/s ² 6 ms 18 (3 each direction)	Converter operating
Eb	Bump (half-sinusoidal)	IEC/EN 60068-2-29 MIL-STD-810D section 516.3	Acceleration amplitude: Bump duration: Number of bumps:	40 g _n = 392 m/s ² 6 ms 6000 (1000 each direction)	Converter operating
Fc	Vibration (sinusoidal)	IEC/EN 60068-2-6	Acceleration amplitude: Frequency (1 Oct/min): Test duration:	0.35 mm (10 to 60 Hz) 5 g _n = 49 m/s ² (60 to 2000 Hz) 10 to 2000 Hz 7.5 h (2.5 h each axis)	Converter operating
Fh	Vibration, broad-band random (digital control)	IEC/EN 60068-2-64	Acceleration spectral density: Frequency band: Acceleration magnitude: Test duration:	0.05 g _n ² /Hz 10 to 500 Hz 4.9 g _{n rms} 3 h (1 h each axis)	Converter operating
Kb	Salt mist, cyclic (sodium chloride NaCl solution)	IEC/EN 60068-2-52	Concentration: Duration: Storage: Cycles and storage duration:	5% (30 °C) 2 h per cycle 40 °C, 93% rel. humidity 3 days, 22 h per cycle	Converter not operating

¹ Covers also EN 50155/EN 61373 category 1, class B, body mounted (= chassis of coach)

Temperatures

Table 10: Temperature specifications, valid for air pressure of 800 to 1200 hPa (800 to 1200 mbar)

Temperature		Conditions	Standard (-8)		Unit
Characteristics			min	max	
T _A	Ambient temperature	Operational ¹	-40	85	°C
T _C	Case temperature		-40	105	
T _S	Storage temperature	Non operational	-55	105	

¹ See *Thermal Considerations*

Failure Rates

Table 11: MTBF

MTBF	Ground benign T _C = 40 °C	Ground fixed		Ground mobile T _C = 50 °C	Unit
		T _C = 40 °C	T _C = 70 °C		
40IMX4-05-8 (MIL-HDBK-217F)	890 000	440 000	247 000	362 000	h
40IMX4-1212-8 (Bellcore)	3 535 000	1 768 000	917 000	476 000	

Safety and Installation Instructions

Installation Instruction

Installation of the dc-dc converters must strictly follow the national safety regulations in compliance with the enclosure, mounting, creepage, clearance, casualty, markings and segregation requirements of the end-use application.

Connection to the system shall be made via a printed circuit board; see *Mechanical Data*.

The converters should be connected to a secondary circuit.

Do not open the converter.

Ensure that a converter failure does not result in a hazardous condition.

To prevent excessive current flowing through the input lines in case of a short-circuit, an external fuse specified in table 6 should be installed in the non-earthed input supply line.

Pin Allocation



Fig. 18
Foot print

Table 12: Pin allocation for standard and option Z

Pin	Single-output models	Dual-output models
2	Vi-	Vi-
3	Vi-	Vi-
10	n.c.	--
11	--	Vo-
14	Vo+	Vo+
16	Vo-	Go
22	Vi+	Vi+
23	Vi+	Vi+

Table 13: Pin allocation for option K

Pin	Single-output models	Dual-output models
1	Vi+	Vi+
2	n.c.	--
10	--	Go
11	--	Go
12	Vo-	--
13	Vo+	Vo-
15	--	Vo+
24	Vi-	Vi-

Standards and Approvals

The converters are approved according to UL/CSA 60950, IEC 60950-1:2001 and IEC/EN 60950-1 2nd Edition.

The converters have been evaluated for:

- Building-in
- Basic insulation input to output, based on their maximum input voltage
- Pollution degree 2 environment
- Connecting the input to a secondary circuit, which is subject to a maximum transient rating of 1500 V for 20IMX4 and 40IMX4, and 2000 V for 70IMX4 models.

The converters are subject to manufacturing surveillance in accordance with the above mentioned standards and with ISO 9001:2000.

Railway Applications

To comply with railway standards, all components are coated with a protective lacquer (except option Z).

Protection Degree

The protection degree of the converters is IP 30, except open-frame models (option Z).

Cleaning Liquids

In order to avoid possible damage, any penetration of cleaning fluids should be prevented, since the power supplies are not hermetical sealed.

However, open-frame models (option Z) leave the factory unlacquered; they may be lacquered by the customer, for instance together with the mother board. Cleaning agents are not permitted – except washing at room temperature with isopropyl alcohol. If necessary, the mother board must be cleaned, before fitting the open-frame converter.

Note: Cleaning liquids may damage the adhesive joints of the ferrite cores.

Isolation

The electric strength test is performed in the factory as routine test in accordance with EN 50116 and IEC/EN 60950, and should not be repeated in the field. Power-One will not honor any warranty claims resulting from electric-strength field tests.

Table 14: Electric strength test voltages

Characteristic	Input to output			Unit
	5IMX4	20/40IMX4	70IMX4	
Factory test >1 s	0.77	1.2	1.5	kVAC
Equivalent DC test voltage	1.0	1.5	2.0	kVDC
Coupling capacitance	2.2	typ. 1.1	typ. 1.1	nF
Insulation resist. (500 VDC)	--	>100	>100	MΩ

Description of Options

Option K: Alternative Pinout

This pinout is compatible with other converters on the market.

Option Z: Open Frame

For applications, where the protection of the case is not necessary or in the case that the motherboard should be cleaned and lacquered with the converter fitted.

Option G: RoHS-6

Converters with a type designation ending with G are RoHS-compatible for all six substances.

NUCLEAR AND MEDICAL APPLICATIONS - Power-One products are not designed, intended for use in, or authorized for use as critical components in life support systems, equipment used in hazardous environments, or nuclear control systems without the express written consent of the respective divisional president of Power-One, Inc.

TECHNICAL REVISIONS - The appearance of products, including safety agency certifications pictured on labels, may change depending on the date manufactured. Specifications are subject to change without notice.

Mouser Electronics

Authorized Distributor

Click to View Pricing, Inventory, Delivery & Lifecycle Information:

Bel Power Solutions:

[20IMX4-0505-8KG](#) [20IMX4-1212-8G](#) [40IMX4-03-8G](#) [20IMX4-12-8G](#) [40IMX4-05-8G](#) [20IMX4-05-8KG](#) [20IMX4-03-8G](#) [20IMX4-05-8G](#) [20IMX4-15-8KG](#) [40IMX4-1515-8KG](#) [40IMX4-2424-8G](#) [20IMX4-0505-8G](#) [40IMX4-1515-8G](#) [20IMX4-12-8KG](#) [20IMX4-15-8G](#) [40IMX4-05-8KG](#) [20IMX4-1212-8KG](#) [20IMX4-1515-8G](#) [40IMX4-0505-8KG](#) [40IMX4-1212-8G](#) [20IMX4-1515-8KG](#) [20IMX4-2424-8G](#) [40IMX4-12-8G](#) [40IMX4-15-8G](#) [70IMX4-05-8G](#) [40IMX4-0505-8](#) [20IMX4-0505-8Z](#)