

LQ104S1DG2A LCD Module

Product Specification

December 2008

SVGA module featuring Strong 2 rating for brightness, contrast, operating range, and shock and vibration tolerance; 350 nits brightness with 500:1 contrast.

| | | |
|-----------------------|--|--|
| PREPARED BY : DATE | SHARP | SPEC No. LD-20903B |
| APPROVED BY : DATE | | FILE No. |
| | | ISSUE : Dec. 12. 2008 |
| | | PAGE : 17 pages |
| | MOBILE LIQUID CRYSTAL DISPLAY GROUP SHARP CORPORATION | APPLICABLE GROUP MOBILE LIQUID CRYSTAL DISPLAY GROUP |
| | SPECIFICATION | |

DEVICE SPECIFICATION FOR
TFT-LCD Module
 MODEL No.
LQ104S1DG2A

These parts have corresponded with the RoHS directive.

CUSTOMER'S APPROVAL

DATE _____

BY _____

PRESENTED
BY *K. Shiono*

K. Shiono
 General manager
 ENGINEERING DEPARTMENT I
 MOBILE LIQUID CRYSTAL DISPLAY DIVISION III
 MOBILE LIQUID CRYSTAL DISPLAY GROUP
 SHARP CORPORATION

1. Application

This specification applies to color TFT-LCD module, LQ104S1DG2A

These specification sheets are the proprietary product of SHARP CORPORATION("SHARP) and include materials protected under copyright of SHARP. Do not reproduce or cause any third party to reproduce them in any form or by any means, electronic or mechanical, for any purpose, in whole or in part, without the express written permission of SHARP.

The device listed in these specification sheets was designed and manufactured for use in general electronic equipment.

In case of using the device for applications such as control and safety equipment for transportation (control of aircraft, trains, automobiles, etc.), rescue and security equipment and various safety related equipment which require higher reliability and safety, take into consideration that appropriate measures such as fail-safe functions and redundant system design should be taken.

Do not use the device for equipment that requires an extreme level of reliability, such as aerospace applications, telecommunication equipment (trunk lines), nuclear power control equipment and medical or other equipment for life support.

SHARP assumes no responsibility for any damage resulting from the use of the device which does not comply with the instructions and the precautions specified in these specification sheets.

Confirm "11. Handling Precautions "(page 12 and 13) item when you use the device.

Contact and consult with a SHARP sales representative for any questions about this device.

2. Overview

This module is a color active matrix LCD module incorporating amorphous silicon TFT (Thin Film Transistor). It is composed of a color TFT-LCD panel, driver ICs, control circuit and power supply circuit and a backlight unit. Graphics and texts can be displayed on a 800×3×600 dots panel with 262,144 colors by supplying 18 bit data signal (6bit/color), four timing signals, +3.3V or +5V DC supply voltage for TFT-LCD panel driving and supply voltage for backlight.

The TFT-LCD panel used for this module is a low-reflection and higher-color-saturation type.

Therefore, this module is also suitable for the multimedia use.

Optimum viewing direction is 6 o'clock.

Backlight-driving DC/AC inverter is not built in this module.

3. Mechanical Specifications

| Parameter | Specifications | Unit |
|----------------------------|----------------------------------|-------|
| Display size | 26 (10.4") Diagonal | cm |
| Active area | 211.2(H) × 158.4(V) | mm |
| Pixel format | 800(H) × 600(V) | pixel |
| | (1 pixel = R + G + B dots) | |
| Pixel pitch | 0.264(H) × 0.264(V) | mm |
| Pixel configuration | R,G,B vertical stripe | |
| Display mode | Normally white | |
| Unit outline dimensions *1 | 246.5(W) × 179.4(H) × 15.5max(D) | mm |
| Mass | 620 max | g |
| Surface treatment | Anti-glare and hard-coating 3H | |

*1 : excluding backlight cables.

Outline dimensions is shown in page 16.

4. Input Terminals

4-1. TFT-LCD panel driving

CN1

Using connector : DF9MA-41P-1V(32) (Hirose Electric Co., Ltd.)

Corresponding connector : DF9-41S-1V(32) (Hirose Electric Co., Ltd.)

DF9A-41S-1V(20)/(22) (Hirose Electric Co., Ltd.)

DF9B-41S-1V(32) (Hirose Electric Co., Ltd.)

DF9M-41S-1V(32) (Hirose Electric Co., Ltd.)

[Note] Please do not use it besides corresponding connector.

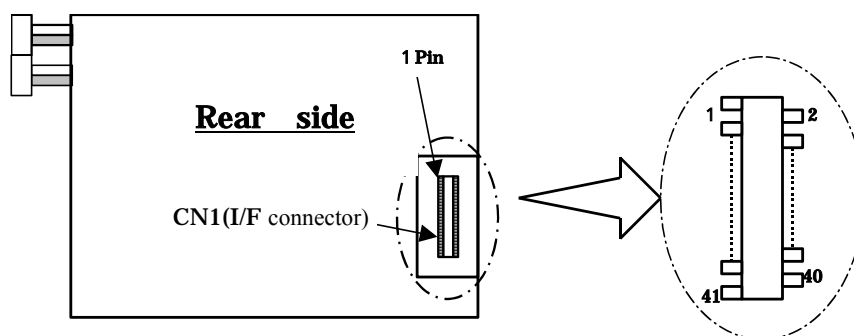

4. Input Terminals

| Pin No. | Symbol | Function | Remark |
|---------|--------|--|---------|
| 1 | GND | - | |
| 2 | CK | Clock signal for sampling each data signal | |
| 3 | GND | - | |
| 4 | Hsync | Horizontal synchronous signal | [Note1] |
| 5 | Vsync | Vertical synchronous signal | [Note1] |
| 6 | GND | - | |
| 7 | GND | - | |
| 8 | GND | - | |
| 9 | R0 | RED data signal(LSB) | |
| 10 | R1 | RED data signal | |
| 11 | R2 | RED data signal | |
| 12 | GND | - | |
| 13 | R3 | RED data signal | |
| 14 | R4 | RED data signal | |
| 15 | R5 | RED data signal(MSB) | |
| 16 | GND | - | |
| 17 | GND | - | |
| 18 | GND | - | |
| 19 | G0 | GREEN data signal(LSB) | |
| 20 | G1 | GREEN data signal | |
| 21 | G2 | GREEN data signal | |
| 22 | GND | - | |
| 23 | G3 | GREEN data signal | |
| 24 | G4 | GREEN data signal | |
| 25 | G5 | GREEN data signal(MSB) | |
| 26 | GND | - | |
| 27 | GND | - | |
| 28 | GND | - | |
| 29 | B0 | BLUE data signal(LSB) | |
| 30 | B1 | BLUE data signal | |
| 31 | B2 | BLUE data signal | |
| 32 | GND | - | |
| 33 | B3 | BLUE data signal | |
| 34 | B4 | BLUE data signal | |
| 35 | B5 | BLUE data signal(MSB) | |
| 36 | GND | - | |
| 37 | ENAB | Signal to settle the horizontal display position | [Note2] |
| 38 | R/L | Horizontal display mode select signal | [Note3] |
| 39 | Vcc | +3.3V / +5.0V power supply | |
| 40 | Vcc | +3.3V / +5.0V power supply | |
| 41 | U/D | Vertical display mode select signal | [Note4] |

The shielding case is connected with GND.

[Note1] The polarity of both synchronous signals are negative.

[Note2] The horizontal display start timing is settled in accordance with a rising timing of ENAB signal.

In case ENAB is fixed "Low", the horizontal start timing is determined as described in 7-2.

Do not keep ENAB "High" during operation.

[Note 3],[Note 4]



R/L = High, U/D = Low



R/L = Low, U/D = Low



R/L = High, U/D = High



R/L = Low, U/D = High

4-3. Backlight driving

CN2 ,CN3

Using connector : BHR-02(8.0)VS-1N (JST)

Corresponding connector : SM02(8.0)B-BHS (JST)

| Pin no. | symbol | Function | Cable color |
|---------|-------------------|---|-------------|
| 1 | V _{HIGH} | Power supply for lamp (High voltage side) | Pink |
| 2 | V _{LOW} | Power supply for lamp (Low voltage side) | White |

5. Absolute Maximum Ratings

| Parameter | Symbol | Condition | Ratings | Unit | Remark |
|-----------------------|------------------|--------------------|------------------------------|------|--------------------|
| Input voltage | V _I | T _a =25 | - 0.3 ~ V _{CC} +0.3 | V | 【Note1】 |
| +5V supply voltage | V _{CC} | T _a =25 | 0 ~ + 6 | V | |
| Storage temperature | T _{stg} | - | -30 ~ 80 | | 【Note2】 【Note4】 |
| Operating temperature | T _{opa} | Panel surface | -30 ~ 80 | | 【Note3】 【Note4】 |

【Note1】 CK,R0 ~ R5,G0 ~ G5,B0 ~ B5,Hsync,Vsync,ENAB, R/L, U/L

【Note2】 Humidity : 95%RH Max. at T_a 50 .Maximum wet-bulb temperature at 39 or less at T_a>50 . (No condensation.)【Note3】 Humidity : 95%RH Max. at T_a 40 .Maximum wet-bulb temperature at 39 or less at T_a>40 . (No condensation.)

【Note4】 There is a possibility of causing deterioration in the irregularity and others of the screen and the display fineness when preserving or using it from 60 to 80 .

6. Electrical Characteristics

6-1.TFT-LCDpaneldriving

Ta = 25

| Parameter | | Symbol | Min. | Typ. | Max. | Unit | Remark |
|---------------------------------|---------------------|------------------|-------|-------------|------|--------------------|-------------------------------|
| Power Supply | Supply voltage | Vcc | +3.0 | +3.3 +5.0 | +5.5 | V | 【 Note1 】 |
| | Current dissipation | Icc | - | 300 | 450 | mA | Vcc=3.3V 【 Note2 】 |
| Icc | | - | 200 | 300 | mA | Vcc=5.0V 【 Note2 】 | |
| Permissive input ripple voltage | | V _{RF} | - | - | 100 | mVp-p | Vcc=5.0V |
| Input voltage (Low) | | V _{IL} | - | - | 0.8 | V | 【 Note3 】 |
| Input voltage (High) | | V _{IH} | 2.1 | - | - | V | |
| Input current 1 | | I _{OL1} | -10.0 | - | 10.0 | μA | V _I =0V 【 Note4 】 |
| | | I _{OH1} | -10.0 | - | 10.0 | μA | V _I =Vcc 【 Note4 】 |
| Input current 2 | | I _{OL2} | -800 | - | - | μA | V _I =0V 【 Note5 】 |
| | | I _{OH2} | -10.0 | - | 10.0 | μA | V _I =Vcc 【 Note5 】 |
| Input current 3 | | I _{OL3} | -10.0 | - | 10.0 | μA | V _I =0V 【 Note6 】 |
| | | I _{OH3} | - | - | 800 | μA | V _I =Vcc 【 Note6 】 |

【 NOTE 1 】

Vcc-turn-on conditions

- T 1 15 ms
- 0 < T 2 10 ms
- 0 < T 3 100 ms
- 0 < T 4 1 s
- T 5 > 200 ms

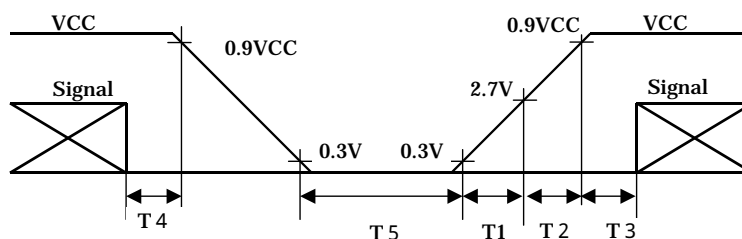

Vcc-dip conditions

- 1) 2.5V Vcc
- td 10ms
- 2) Vcc < 2.5V

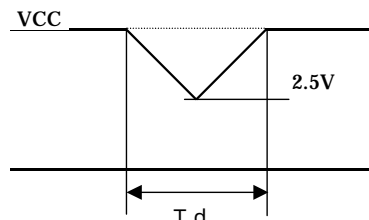

Vcc-dip condition should also follow
The Vcc-turn-on conditions

【 Note2 】 Typical current situation : 16-gray-bar pattern. Vcc=+3.3V/+5.0V

【 Note3 】 CK,R0~R5,G0~G5,B0~B5,Hsync,Vsync,ENAB,R/L,U/D

【 Note4 】 CK,R0~R5,G0~G5,B0~B5,Hsync,Vsync,ENAB

【 Note5 】 R/L

【 Note6 】 U/D

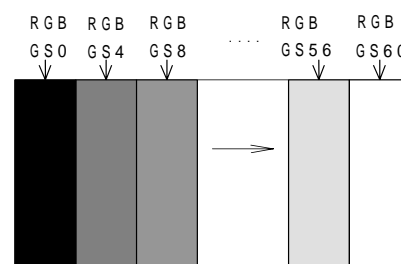

6-2. Backlight driving

The backlight system is an edge-lighting type with double CCFT (Cold Cathode Fluorescent Tube).

The characteristics of single lamp are shown in the following table.

(It is usually required to measure under the following condition. $I_L=6.0\text{mA}$, $T_a=25 \pm 2$, $F_L=60\text{kHz}$.)

| Parameter | Symbol | Min. | Typ. | Max. | Unit | Remark |
|------------------------|--------|------|------|------|--------|--|
| Lamp current | I_L | 3.5 | 6.0 | 7.0 | mA rms | [Note1] |
| Lamp power consumption | P_L | - | 2.8 | - | W | [Note2] |
| Lamp frequency | F_L | 35 | 60 | 70 | kHz | [Note3] |
| Kick-off voltage | V_s | - | - | 1300 | V rms | Inverter output $T_a=-30^\circ\text{C}$ [Note4] |

[Note1] Lamp current is measured with current meter for high frequency as shown below.

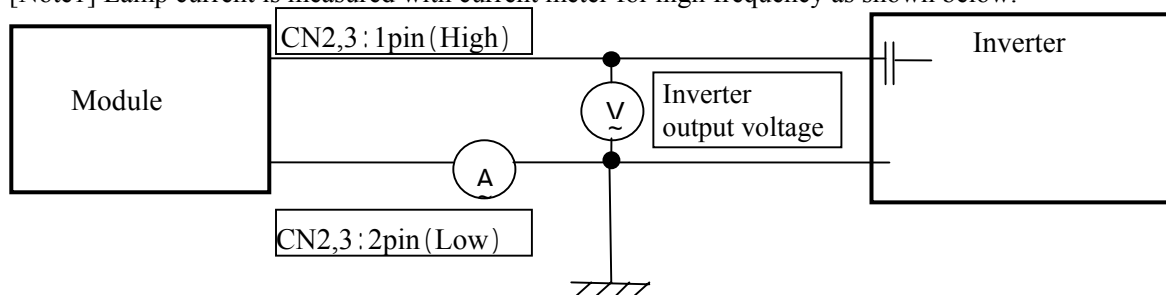

[Note2] Referential data per one CCFT by calculation. ($I_L \times V_L$)

The data don't include loss at inverter. ($I_L = 6.0\text{mA rms}$)

[Note3] Lamp frequency may produce interference with horizontal synchronous frequency, and this may cause beat on the display. Therefore lamp frequency shall be detached as much as possible from the horizontal synchronous frequency and from the harmonics of horizontal synchronous to avoid interference.

[Note4] The open output voltage of the inverter shall be maintained for more than 1s; otherwise the lamp may not be turned on.

[Note5] Lamp is consumables. In the following condition, the lamp life time is 50,000 hours as the reference value and it is not guaranteed in this specification sheet by SHARP.

Above value is applicable when lamp (the long side of LCD module) is placed horizontally. (Landscape position)

Lamp life time is defined that it applied either or under this condition.

(Continuous turning on at $T_a = 25^\circ\text{C}$, $I_L = 6.0\text{mA rms}$)

Brightness becomes 50% of the original value under standard condition.

Kick-off voltage at $T_a = -30^\circ\text{C}$ exceeds maximum value (1300Vrms).

Lamp life time shortens according to the state of mounting and use.

(Lamp lifetime may vary if lamp is in portrait position due to the change of mercury density inside the lamp.)

In case of operating under lower temp environment, the lamp exhaustion is accelerated and the brightness becomes lower.

Continuous operating for around 1 month under lower temp condition may reduce the brightness to half of the original brightness.

In case of such usage under lower temp environment, periodical lamp exchange is recommended.

[Note6] The performance of the backlight, for example life time or brightness, is much influenced by the characteristics of the DC-AC inverter for the lamp.

When you design or order the inverter, please make sure that a poor lighting caused by the mismatch of the backlight and the inverter (miss-lighting, flicker, etc.) never occur. when you confirm it, the module should be operated in the same condition as it is installed in your instrument.

Be sure to use a back light power supply with the safety protection circuit such as the detection circuit for the excess voltage, excess current and or electric discharge waveform.

Be sure to use the detect circuit by which one side of the CCFT lamps can be controlled independently.

Otherwise, when one side of the CCFT is open, the excess current may possibly be applied to the other side of the lamp.

[Note7] It is required to have the inverter designed so that to allow the impedance deviation of the two CCFT lamps and the capacity deviation of barast capacitor.

[Note8] Please make it to the structure not touching directly insulating the high voltage part.

Please stop the circuit by the protection element such as fuses for generation of heat and the ignition prevention, and use a flame resisting and high material for the substrate and the resin material.

[Note9] Under the environment of 10lx or less, miss-lighting delay may occur.

7. Timing Characteristics of input signals

Timing diagrams of input signal are shown in Fig.1.

7-1. Timing characteristics

| Parameter | Symbol | Min. | Typ. | Max. | Unit | Remark | |
|------------------------------|-------------|------|------|------|--------|--------|---|
| Clock | Frequency | 1/Tc | 35.0 | 40.0 | 42.0 | MHz | - |
| | High time | Tch | 6 | - | - | ns | - |
| | Low time | Tcl | 6 | - | - | ns | - |
| | Duty ratio | Th/T | 40 | 50 | 60 | % | - |
| Data | Setup time | Tds | 3 | - | - | ns | - |
| | Hold time | Tdh | 5 | - | - | ns | - |
| Horizontal sync. signal | Cycle | TH | 20.8 | 26.4 | 39.9 | μs | - |
| | | | 832 | 1056 | 1395 | clock | - |
| | Pulse width | THp | 2 | 128 | 200 | clock | - |
| Vertical sync. signal | Cycle | TV | 628 | 666 | 798 | line | - |
| | Pulse width | TVp | 2 | 4 | 6 | line | - |
| Horizontal display period | | THd | 800 | 800 | 800 | clock | - |
| Hsync-Clock phase difference | | THc | 3 | - | Tc-10 | ns | - |
| Hsync-Vsync phase difference | | TVh | 1 | - | TH-THp | clock | - |
| Vertical data start position | | TVs | 23 | 23 | 23 | line | - |

[Note] In case of lower frequency, the deterioration of display quality, flicker etc., may be occurred.

7-2. Horizontal display position

The horizontal display position is determined by ENAB signal and the input data corresponding to the rising edge of ENAB signal is displayed at the left end of the active area.

| Parameter | symbol | Min. | Typ. | Max. | Unit | Remark | |
|--------------------------------------|-------------|------|------|------|------------|--------|---|
| Enable signal | Setup time | Tes | 5 | - | Tc-10 | ns | - |
| | Pulse width | Tep | 2 | 800 | TH-10 | clock | - |
| Hsync-Enable signal phase difference | | THE | 0 | - | TH-THp-800 | clock | - |

[Note] When ENAB is fixed "Low", the display starts from the data of C88(clock) as shown in Fig.1.

7-3. Vertical display position

The vertical display position, TVs is fixed "23" (line).

7-4. Input Data Signals and Display Position on the screen

Display position of input data

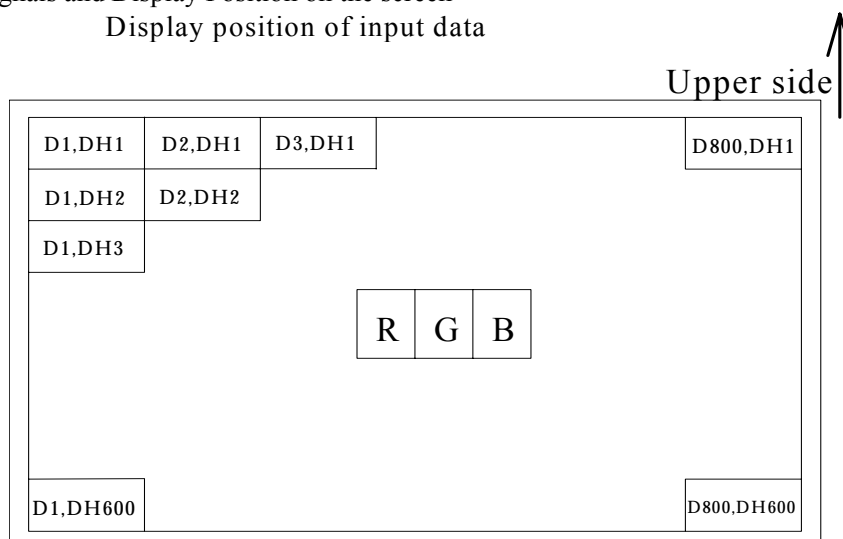

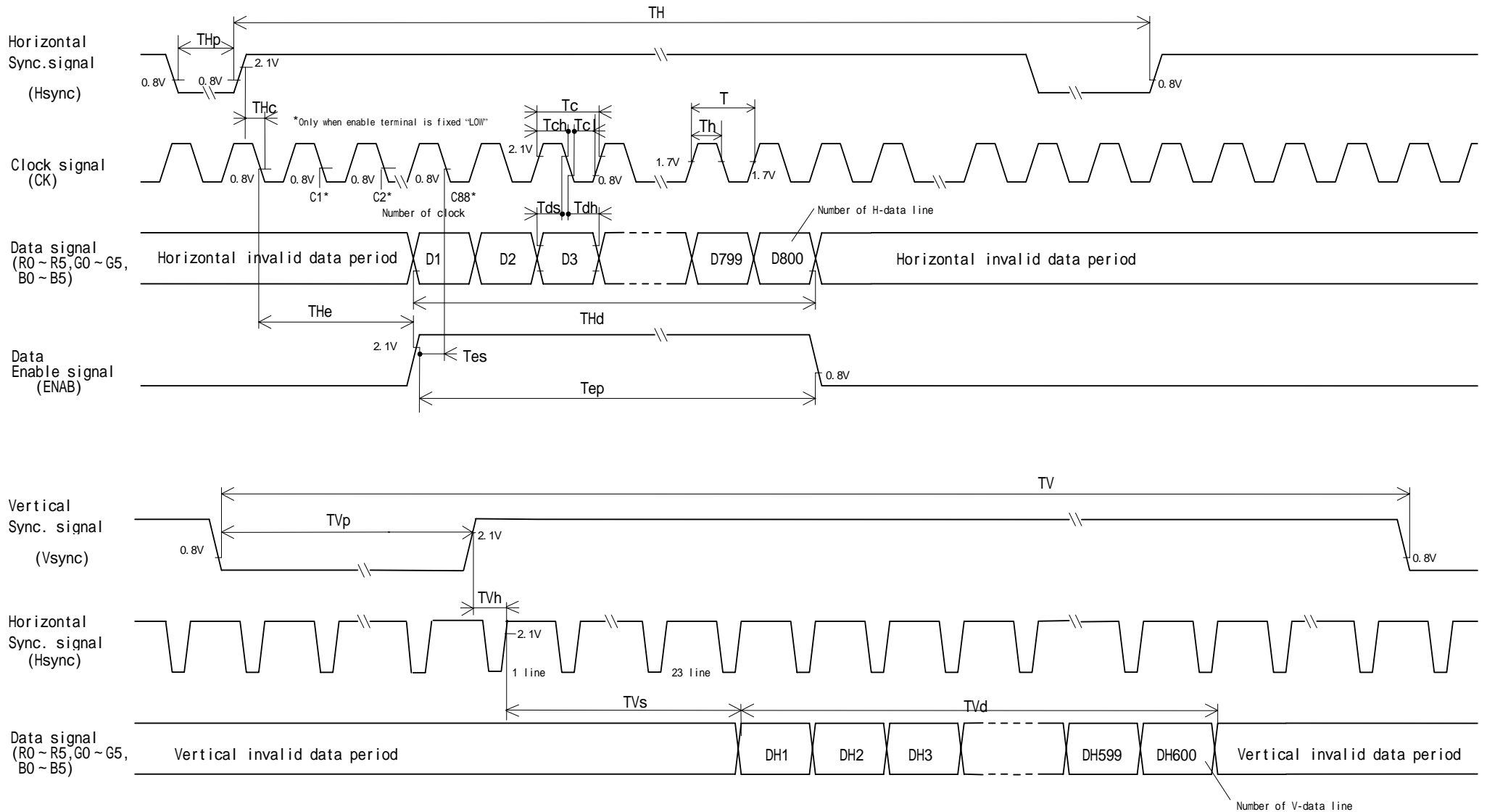

Fig. 1 Input signal waveforms

8. Input Signals, Basic Display Colors and Gray Scale of Each Color

| | Colors & | Data signal | | | | | | | | | | | | | | | | | | |
|---------------------|------------|-------------|----|----|----|----|----|----|----|----|----|----|----|----|----|----|----|----|----|----|
| | Gray scale | Gray Scale | R0 | R1 | R2 | R3 | R4 | R5 | G0 | G1 | G2 | G3 | G4 | G5 | B0 | B1 | B2 | B3 | B4 | B5 |
| Basic Color | Black | - | 0 | 0 | 0 | 0 | 0 | 0 | 0 | 0 | 0 | 0 | 0 | 0 | 0 | 0 | 0 | 0 | 0 | 0 |
| | Blue | - | 0 | 0 | 0 | 0 | 0 | 0 | 0 | 0 | 0 | 0 | 0 | 0 | 1 | 1 | 1 | 1 | 1 | 1 |
| | Green | - | 0 | 0 | 0 | 0 | 0 | 0 | 1 | 1 | 1 | 1 | 1 | 1 | 0 | 0 | 0 | 0 | 0 | 0 |
| | Cyan | - | 0 | 0 | 0 | 0 | 0 | 0 | 1 | 1 | 1 | 1 | 1 | 1 | 1 | 1 | 1 | 1 | 1 | 1 |
| | Red | - | 1 | 1 | 1 | 1 | 1 | 1 | 0 | 0 | 0 | 0 | 0 | 0 | 0 | 0 | 0 | 0 | 0 | 0 |
| | Magenta | - | 1 | 1 | 1 | 1 | 1 | 1 | 0 | 0 | 0 | 0 | 0 | 0 | 1 | 1 | 1 | 1 | 1 | 1 |
| | Yellow | - | 1 | 1 | 1 | 1 | 1 | 1 | 1 | 1 | 1 | 1 | 1 | 1 | 0 | 0 | 0 | 0 | 0 | 0 |
| | White | - | 1 | 1 | 1 | 1 | 1 | 1 | 1 | 1 | 1 | 1 | 1 | 1 | 1 | 1 | 1 | 1 | 1 | 1 |
| Gray Scale of Red | Black | GS0 | 0 | 0 | 0 | 0 | 0 | 0 | 0 | 0 | 0 | 0 | 0 | 0 | 0 | 0 | 0 | 0 | 0 | 0 |
| | ↑ | GS1 | 1 | 0 | 0 | 0 | 0 | 0 | 0 | 0 | 0 | 0 | 0 | 0 | 0 | 0 | 0 | 0 | 0 | 0 |
| | Darker | GS2 | 0 | 1 | 0 | 0 | 0 | 0 | 0 | 0 | 0 | 0 | 0 | 0 | 0 | 0 | 0 | 0 | 0 | 0 |
| | ↑ | ↓ | ↓ | | | | | ↓ | | | | | ↓ | | | | | | | |
| | ↓ | ↓ | ↓ | | | | | ↓ | | | | | ↓ | | | | | | | |
| | Brighter | GS61 | 1 | 0 | 1 | 1 | 1 | 1 | 0 | 0 | 0 | 0 | 0 | 0 | 0 | 0 | 0 | 0 | 0 | 0 |
| | ↓ | GS62 | 0 | 1 | 1 | 1 | 1 | 1 | 0 | 0 | 0 | 0 | 0 | 0 | 0 | 0 | 0 | 0 | 0 | 0 |
| | Red | GS63 | 1 | 1 | 1 | 1 | 1 | 1 | 0 | 0 | 0 | 0 | 0 | 0 | 0 | 0 | 0 | 0 | 0 | 0 |
| Gray Scale of Green | Black | GS0 | 0 | 0 | 0 | 0 | 0 | 0 | 0 | 0 | 0 | 0 | 0 | 0 | 0 | 0 | 0 | 0 | 0 | 0 |
| | ↑ | GS1 | 0 | 0 | 0 | 0 | 0 | 0 | 1 | 0 | 0 | 0 | 0 | 0 | 0 | 0 | 0 | 0 | 0 | 0 |
| | Darker | GS2 | 0 | 0 | 0 | 0 | 0 | 0 | 0 | 1 | 0 | 0 | 0 | 0 | 0 | 0 | 0 | 0 | 0 | 0 |
| | ↑ | ↓ | ↓ | | | | | ↓ | | | | | ↓ | | | | | | | |
| | ↓ | ↓ | ↓ | | | | | ↓ | | | | | ↓ | | | | | | | |
| | Brighter | GS61 | 0 | 0 | 0 | 0 | 0 | 0 | 1 | 0 | 1 | 1 | 1 | 1 | 0 | 0 | 0 | 0 | 0 | 0 |
| | ↓ | GS62 | 0 | 0 | 0 | 0 | 0 | 0 | 0 | 1 | 1 | 1 | 1 | 1 | 0 | 0 | 0 | 0 | 0 | 0 |
| | Green | GS63 | 0 | 0 | 0 | 0 | 0 | 0 | 1 | 1 | 1 | 1 | 1 | 1 | 0 | 0 | 0 | 0 | 0 | 0 |
| Gray Scale of Blue | Black | GS0 | 0 | 0 | 0 | 0 | 0 | 0 | 0 | 0 | 0 | 0 | 0 | 0 | 0 | 0 | 0 | 0 | 0 | 0 |
| | ↑ | GS1 | 0 | 0 | 0 | 0 | 0 | 0 | 0 | 0 | 0 | 0 | 0 | 0 | 1 | 0 | 0 | 0 | 0 | 0 |
| | Darker | GS2 | 0 | 0 | 0 | 0 | 0 | 0 | 0 | 0 | 0 | 0 | 0 | 0 | 0 | 1 | 0 | 0 | 0 | 0 |
| | ↑ | ↓ | ↓ | | | | | ↓ | | | | | ↓ | | | | | | | |
| | ↓ | ↓ | ↓ | | | | | ↓ | | | | | ↓ | | | | | | | |
| | Brighter | GS61 | 0 | 0 | 0 | 0 | 0 | 0 | 0 | 0 | 0 | 0 | 0 | 0 | 1 | 0 | 1 | 1 | 1 | 1 |
| | ↓ | GS62 | 0 | 0 | 0 | 0 | 0 | 0 | 0 | 0 | 0 | 0 | 0 | 0 | 0 | 1 | 1 | 1 | 1 | 1 |
| | Blue | GS63 | 0 | 0 | 0 | 0 | 0 | 0 | 0 | 0 | 0 | 0 | 0 | 0 | 1 | 1 | 1 | 1 | 1 | 1 |

0 : Low level voltage, 1 : High level voltage

Each basic color can be displayed in 64 gray scales from 6 bit data signals. According to the combination of total 18 bit data signals, the 262,144-color display can be achieved on the screen.

9. Optical Characteristics

Ta=25 , Vcc=+3.3V / +5.0V

| Parameter | | Symbol | Condition | Min. | Typ. | Max. | Unit | Remark |
|--|------------|----------------|-------------------------------|------|-------|------|-------------------|---------------------------|
| Viewing angle range | Horizontal | 21, 22 | CR>10 | 60 | 70 | - | Deg. | [Note1] |
| | Vertical | 11 | | 45 | 50 | - | Deg. | [Note4] |
| | | 12 | | 45 | 60 | - | Deg. | |
| Contrast ratio | | CRn | =0° | 150 | - | - | | [Note2] |
| | | CRo | Optimum viewing angle | - | 500 | - | | [Note4] |
| Response time | Rise | r | =0° | - | 10 | - | ms | [Note3] |
| | Decay | d | | - | 25 | - | ms | [Note4] |
| Chromaticity of white | | x | | - | 0.313 | - | | [Note4] |
| | | y | | - | 0.329 | - | | I _L =6.0mA rms |
| Luminance of white | | Y _L | | 280 | 350 | - | cd/m ² | F _L =60kHz |
| White Uniformity | | δ _w | | - | - | 1.45 | | [Note5] |
| Viewing Angle range as a Brightness Definition | Horizontal | 21, 22 | 50% of the maximum brightness | - | 35 | - | Deg. | [Note1] |
| | Vertical | 11 | | - | 25 | - | Deg. | (Reference value) |
| | | 12 | | - | 30 | - | Deg. | |

[Note] The measurement shall be executed 30 minutes after lighting at rating. (condition: I_L=6.0mA rms)
 The optical characteristics shall be measured in a dark room or equivalent state with the method shown in Fig.2 below.

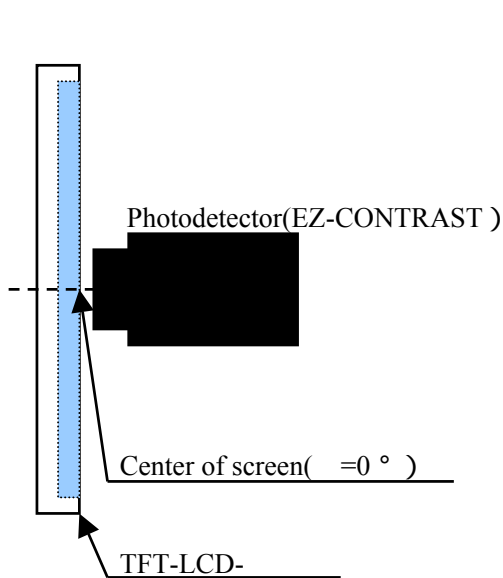

Fig.2-1 Viewing angle measurement method

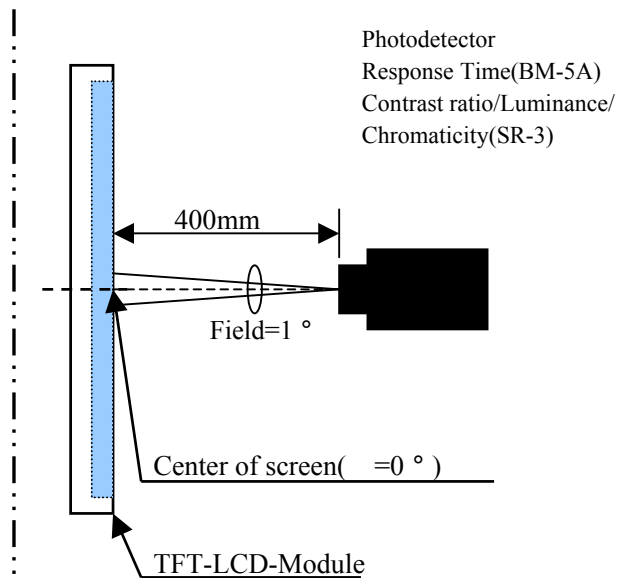
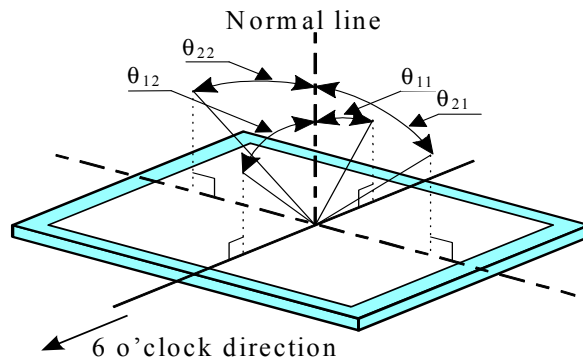

Fig.2-2 Luminance/Contrast ratio/Response time/Chromaticity measurement method

Fig.2 Optical characteristics measurement method

[Note1] Definitions of viewing angle range:



[Note2] Definition of contrast ratio:

The contrast ratio is defined as the following.

$$\text{Contrast Ratio (CR)} = \frac{\text{Luminance (brightness) with all pixels white}}{\text{Luminance (brightness) with all pixels black}}$$

[Note3] Definition of response time:

The response time is defined as the following figure and shall be measured by switching the input signal for "black" and "white" .

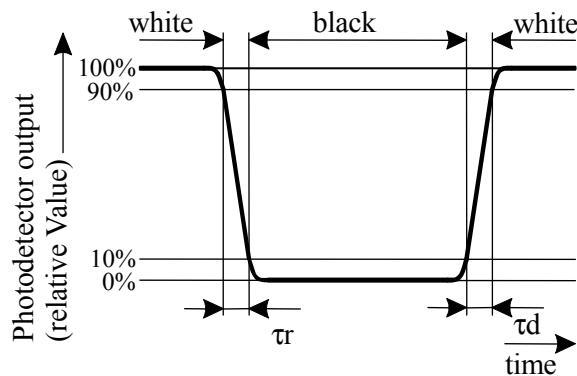

[Note4] This shall be measured at center of the screen.

[Note5] Definition of white uniformity:

White uniformity is defined as the following with five measurements (A ~ E).

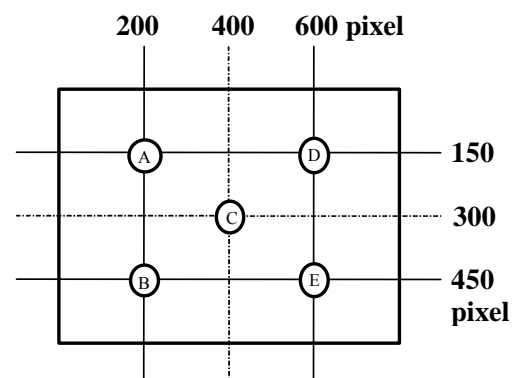

$$w = \frac{\text{Maximum Luminance of five points (brightness)}}{\text{Minimum Luminance of five points (brightness)}}$$

10. Display Quality

The display quality of the color TFT-LCD module shall be in compliance with the Incoming Inspection Standard.

11. Handling Precautions

- a) Be sure to turn off the power supply when inserting or disconnecting the cable.
- b) Be sure to design the cabinet so that the module can be installed without any extra stress such as warp or twist.
- c) Since the front polarizer is easily damaged, pay attention not to scratch it.
Blow away dust on the polarizer with antistatic N₂ blow. It is undesirable to wipe off because a polarizer is sensitive.
It is recommended to peel off softly using the adhesive tape when soil or finger oil is stuck to the polarizer.
When unavoidable, wipe off carefully with a cloth for wiping lenses.
- d) Wipe off water drop immediately. Long contact with water may cause discoloration or spots.
- e) When the panel surface is soiled, wipe it with absorbent cotton or other soft cloth.
- f) Since the panel is made of glass, it may break or crack if dropped or bumped on hard surface. Handle with care.
- g) Since CMOS LSI is used in this module, take care of static electricity and injure the human earth when handling. Observe all other precautionary requirements in handling components.
- h) Since there is a circuit board in the module back, stress is not added at the time of a design assembly.
Please make it like. If stress is added, there is a possibility that circuit parts may be damaged.
- i) Protection film is attached to the module surface to prevent it from being scratched .
Peel the film off slowly , just before the use, with strict attention to electrostatic charges.
Blow off 'dust' on the polarizer by using an ionized nitrogen.
- j) The polarizer surface on the panel is treated with Anti-Glare for low reflection. In case of attaching protective board over the LCD, be careful about the optical interface fringe etc. which degrades display quality.
- k) Do not expose the LCD panel to direct sunlight. Lightproof shade etc. should be attached when LCD panel is used under such environment. The panel characteristic might be deteriorated and the display fineness decrease when strong light is irradiated to the liquid crystal panel.
- l) Connect GND to 4 place of mounting holes to stabilize against EMI and external noise.
- m) There are high voltage portions on the backlight and very dangerous. Careless touch may lead to electrical shock.
When exchange lamps or service, turn off the power without fail.
- n) When handling LCD modules and assembling them into cabinets, that long-terms storage in the environment of oxidization or deoxidization gas and the use of such materials as reagent, solvent, adhesive, resin, etc. which generate these gasses, causes corrosion and discoloration of the modules.
Therefore, please avoid these use.
Epoxy resin (amine series curing agent), silicone adhesive material (dealcoholization series and oxime series), tray forming agent (azo compound) etc, in the cabinet or the packing materials may induce abnormal display with polarizer film deterioration regardless of contact or noncontact to polarizer film.
Be sure to confirm the component of them.
- o) Cold cathode fluorescent lamp in LCD panel contains a small amount of mercury, please follow local ordinances or regulations for disposal.
- p) Be careful of a back light lead not to pull by force at the time of the wiring to an inverter, or line processing.
- q) When install LCD modules in the cabinet, please tighten with “torque = $0.294 \pm 0.02\text{N} \cdot \text{m}$ ($3.0 \pm 0.2\text{kgf} \cdot \text{cm}$)”.
Be sure to confirm it in the same condition as it is installed in your instrument.
- r) Liquid crystal contained in the panel may leak if the LCD is broken. Rinse it as soon as possible if it gets inside your eye or mouth by mistake.
- s) Notice: Never dismantle the module , because it will cause failure. Moreover, please do not peel off the tapes other than the creped paper tape (yellow tape) of a protection film pasted to the product and a lamp connector temporary stop.
- t) Be careful when using it for long time with fixed pattern display as it may cause afterimage.
(Please use a screen saver etc., in order to avoid an afterimage.)

u) Adjusting volume have been set optimally before shipment, so do not change any adjusted value.

If adjusted value is changed, the specification may not be satisfied.

v) If a minute particle enters in the module and adheres to an optical material, it may cause display non-uniformity issue, etc.

Therefore, fine-pitch filters have to be installed to cooling and inhalation hole if you intend to install a fan.

w) The lamp used for this product is very sensitive to the temperature.

Luminance decreases rapidly when it is used for a long time or repeatedly under the environment of the low temperature or the module is being cooled.

Please avoid the continuous or repeating use of it under such an environment.

It may decrease up to 50% of the initial luminance in about one month under the low temperature environment.

Please consult our company when it is used under the environment like the above mentioned.

12. Packing form

| | | |
|---|--------------------------|-------|
| Product countries / Areas | JAPAN | CHINA |
| Piling number of cartons | 5(Max) | |
| Package quantity in one carton | 20pcs | |
| Carton size | 494(W) × 326(D) × 433(H) | |
| Total mass of one carton filled with full modules | 15.6kg(Max) | |
| Packing form is shown | Page 17 | |

13 . Reliability test items

| No. | Test item | Conditions | Remark |
|-----|---|--|--------|
| 1 | High temperature & high humidity storage test | Ta= 50 ; 95%RH 240h (No condensation) | |
| 2 | High temperature storage test | Ta= 80 240h | |
| 3 | Low temperature storage test | Ta= -30 240h | |
| 4 | High temperature & high humidity operation test | Ta= 40 ; 95%RH 240h (No condensation) | |
| 5 | High temperature operation test | Ta (panel surface) = 80 240h | |
| 6 | Low temperature operation test | Ta= -30 240h | |
| 7 | Vibration test (non- operating) | Frequency: 10 ~ 57Hz/Vibration width (one side):0.153mm : 57 ~ 500Hz/Gravity:14.7m/s ² Sweep time : 11 minutes Test period : 3 hours (1 hour for each direction of X,Y,Z) | |
| 8 | Shock test (non- operating) | Max. gravity : 490m/s ² Pulse width : 11ms, half sine wave Direction : ± X, ± Y, ± Z Once for each direction. | |

【Result Evaluation Criteria】

Under the display quality test conditions with normal operation state, these shall be no change which may affect practical display function.

14.Others

14-1. Label

Lot No. Label:

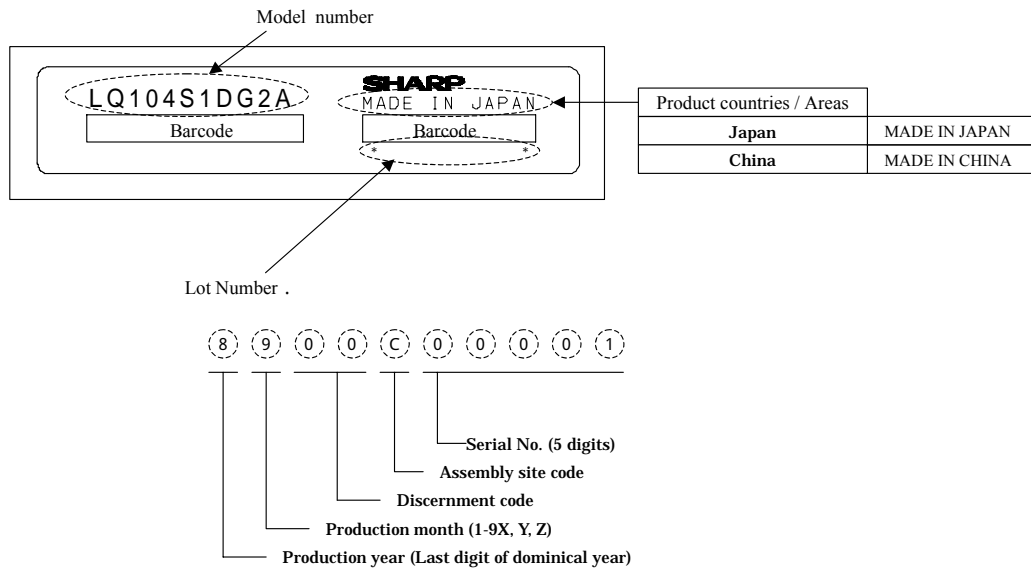

Packing box Label:

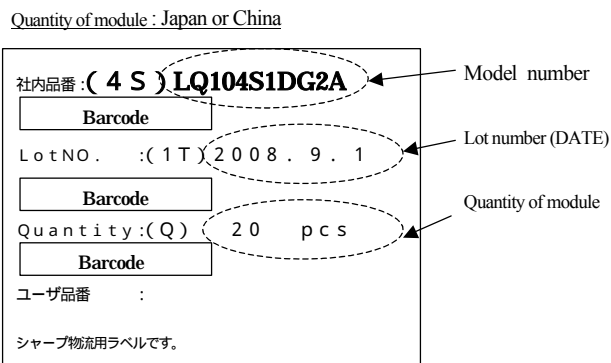

The figure right below is written to the packing box of the settlement for the RoHS restriction.
 R.C. (RoHS Compliance) means it suits the RoHS directive.
 This LCD module is compliant with RoHS Directive.

Internal Use Only
R . C .

14-2. The chemical ozone depleting substance is not used.

14-3. Cold cathode fluorescent lamp in LCD panel contains a small amount of mercury, please follow local ordinances or regulations for disposal. (It marks on the back of the module.)

• COLD CATHODE FLUORESCENT LAMP IN LCD PANEL
CONTAINS A SMALL AMOUNT OF MERCURY, PLEASE FOLLOW
LOCAL ORDINANCES OR REGULATIONS FOR DISPOSAL.

• 当該液晶ディスプレイパネルは蛍光管が組込まれてい
ますので、地方自治体の条例、または、規則に従って
廃棄してください。

14-4. Keeping environment condition

Temperature 0 ~ 40

Relative humidity 95% or less

【Note】 • Please manage as a mean value of the keeping temperature humidity environment referring to the following condition.

Summer time 20 ~ 35 85% or less

Winter 5 ~ 15 85% or less

• Please manage in total within 240 hours at the time kept under the environment of 40 ,95%RH.

Direct sunshine

Please keep it in the state of wrapping or the darkroom so that direct sunshine should not strike directly into the product.

Atmosphere

Please do not keep it in the place with the danger of the generation of the causticity gas and the volatile solvent.

Asking for be dewy prevention

- Please do not put directly on the floor, and keep the wrapping box on the palette or the stand to avoid the be dewy. Moreover, please arrange it in a constant direction correctly to improve ventilation under the palette.
- Please separate from the wall in the storage warehouse and keep it.
- Please note that ventilation is improved and consider the installation such as ventilators in the warehouse.
- Please manage so that there is no rapid temperature change more than natural environment.

Keeping period

Please make it to keeping within one year under the above-mentioned keeping condition.

14-5. If any problem occurs in relation to the description of this specification, it shall be resolved through discussion with spirit of cooperation.

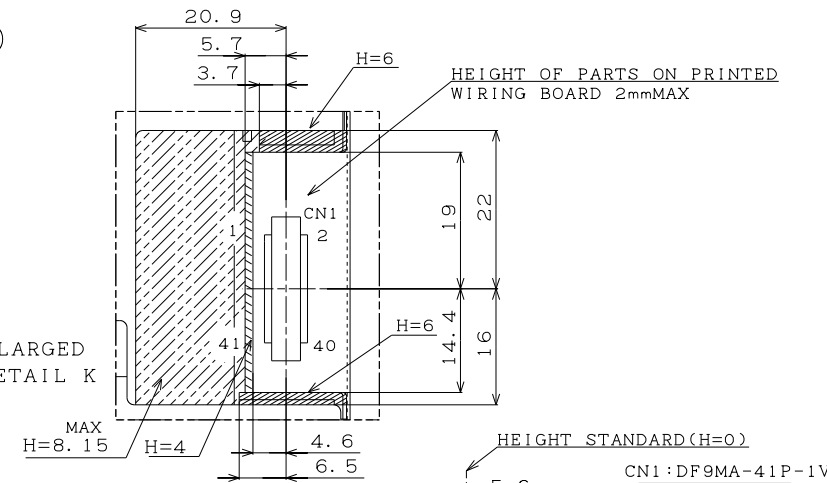
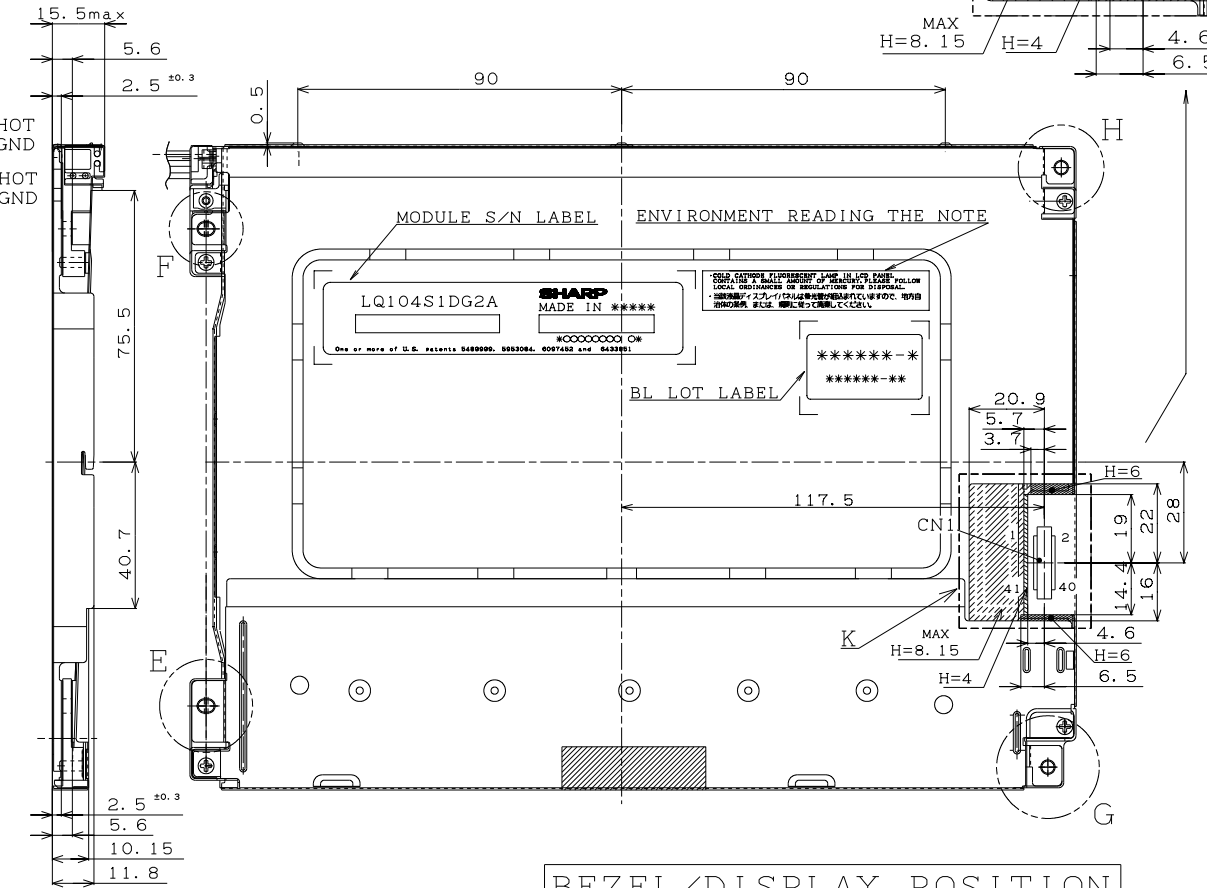
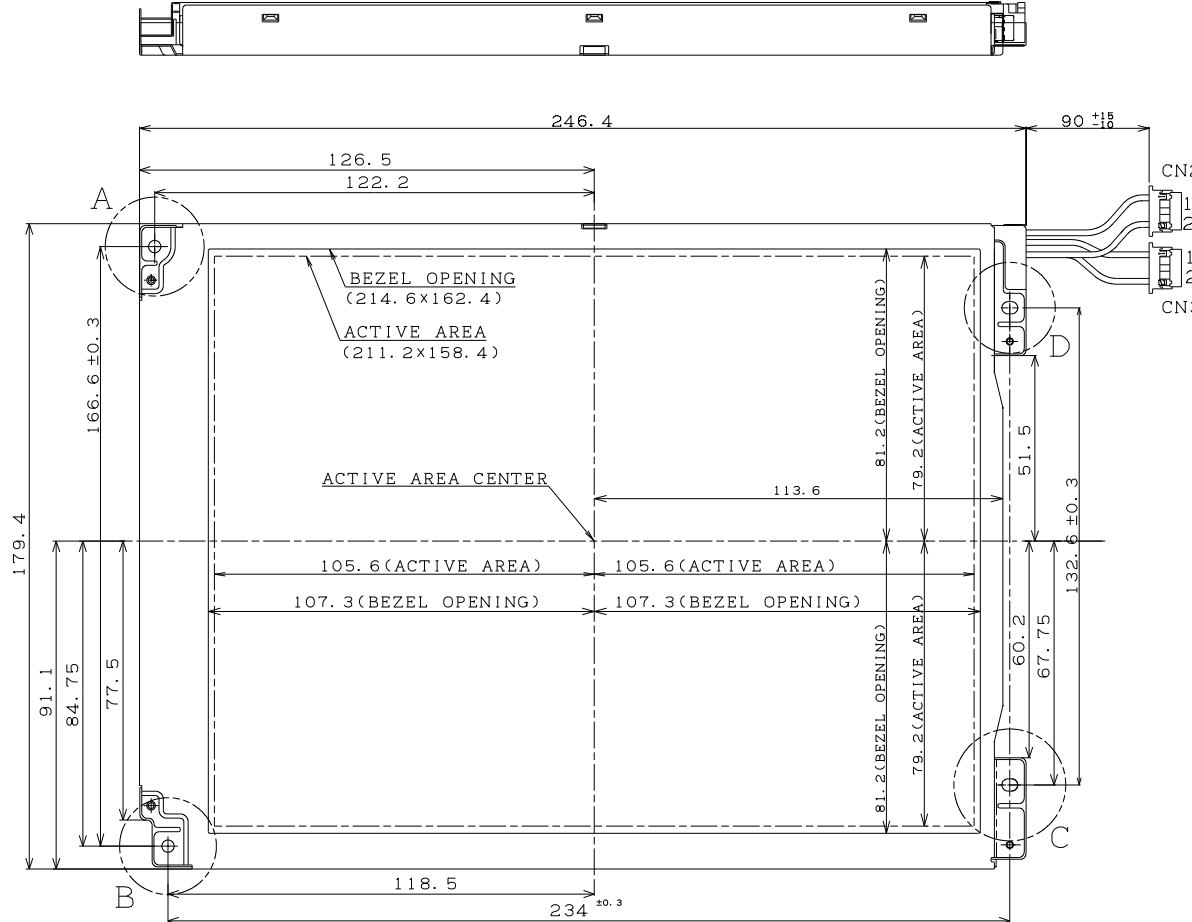
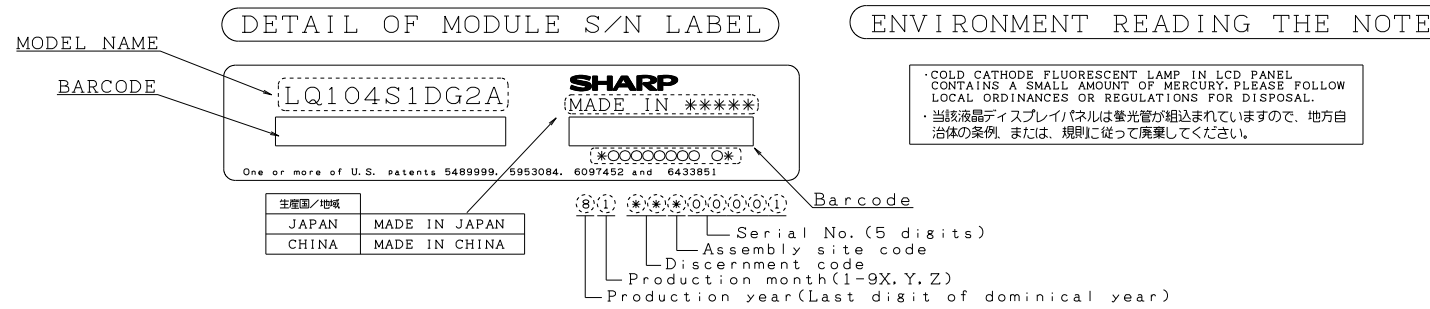

CN1: DF9MA-41P-1V

| | |
|----|-------|
| 1 | GND |
| 2 | CK |
| 3 | GND |
| 4 | Hsync |
| 5 | Vsync |
| 6 | GND |
| 7 | GND |
| 8 | GND |
| 9 | RO |
| 10 | R1 |
| 11 | R2 |
| 12 | GND |
| 13 | R3 |
| 14 | R4 |
| 15 | R5 |
| 16 | GND |
| 17 | GND |
| 18 | GND |
| 19 | G0 |
| 20 | G1 |
| 21 | G2 |
| 22 | GND |
| 23 | G3 |
| 24 | G4 |
| 25 | G5 |
| 26 | GND |
| 27 | GND |
| 28 | GND |
| 29 | B0 |
| 30 | B1 |
| 31 | B2 |
| 32 | GND |
| 33 | B3 |
| 34 | B4 |
| 35 | B5 |
| 36 | GND |
| 37 | ENAB |
| 38 | R/L |
| 39 | Vcc |
| 40 | Vcc |
| 41 | U/D |

CN2, CN3: BHR-02(8.0)VS-1N (JST)

| | |
|---|-------|
| 1 | VHigh |
| 2 | NC |
| 3 | VLow |

BEZEL/DISPLAY POSITION

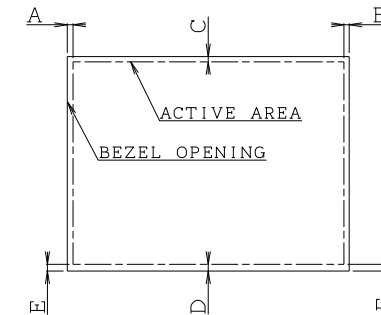

- 1) TOLERANCE X-DIRECTION A: 1.7 ± 0.8
- 2) TOLERANCE X-DIRECTION B: 1.7 ± 0.8
- 3) TOLERANCE Y-DIRECTION C: 2.0 ± 0.8
- 4) TOLERANCE Y-DIRECTION D: 2.0 ± 0.8
- 5) OBLIQUITY OF DISPLAY AREA |E-F| < 0.8

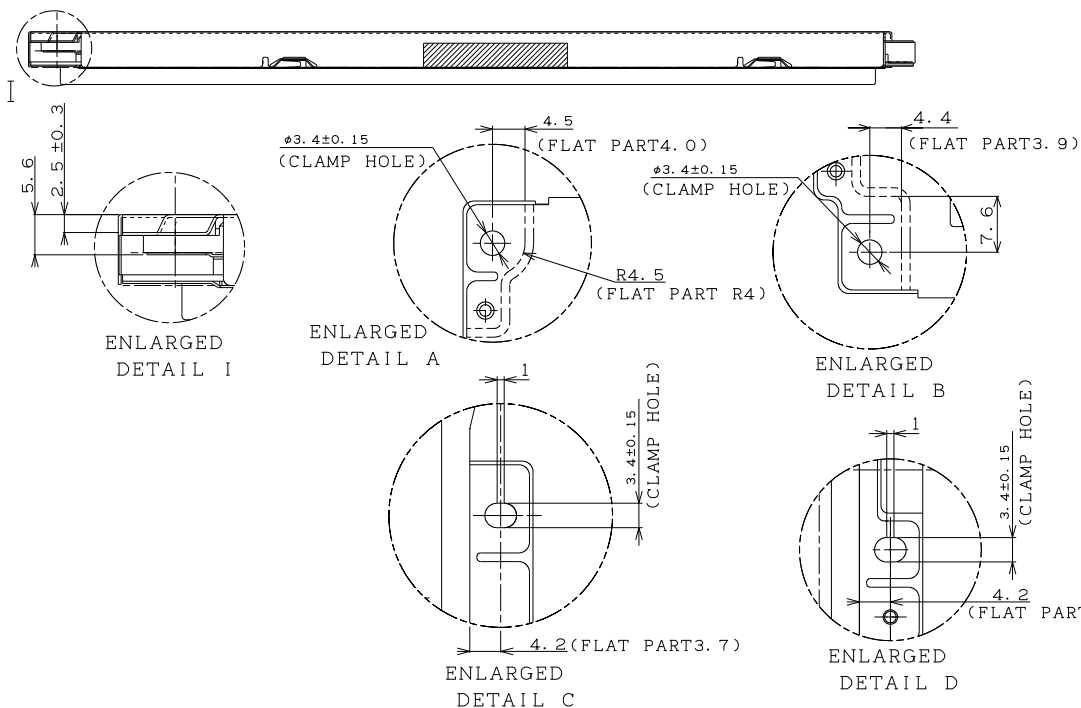

NOTES

- 1) UNSPECIFIED TOLERANCE TO BE ± 0.5 .
- 2) WARPING OF COMPONENTS SUCH AS TAPE, BEZEL, PCB, CHASSIS, FPC, PROTECTION COVER, ETC. ARE EXCLUDED FROM THICKNESS AND DIMENSIONS OF THE MODULE.
- 3) FRONT SIDE: REGARDING THE HEIGHT OF USER'S BOSSES, PLEASE DESIGN THEM FROM $\phi 6$ mm TO $\phi 7$ mm.
- 4) REAR SIDE: REGARDING THE HEIGHT OF USER'S BOSSES, PLEASE DESIGN THEM FROM $\phi 6$ mm TO $\phi 7.5$ mm.

LQ104S1DG2A OUTLINE DIMENSIONS

MASTER CARTON

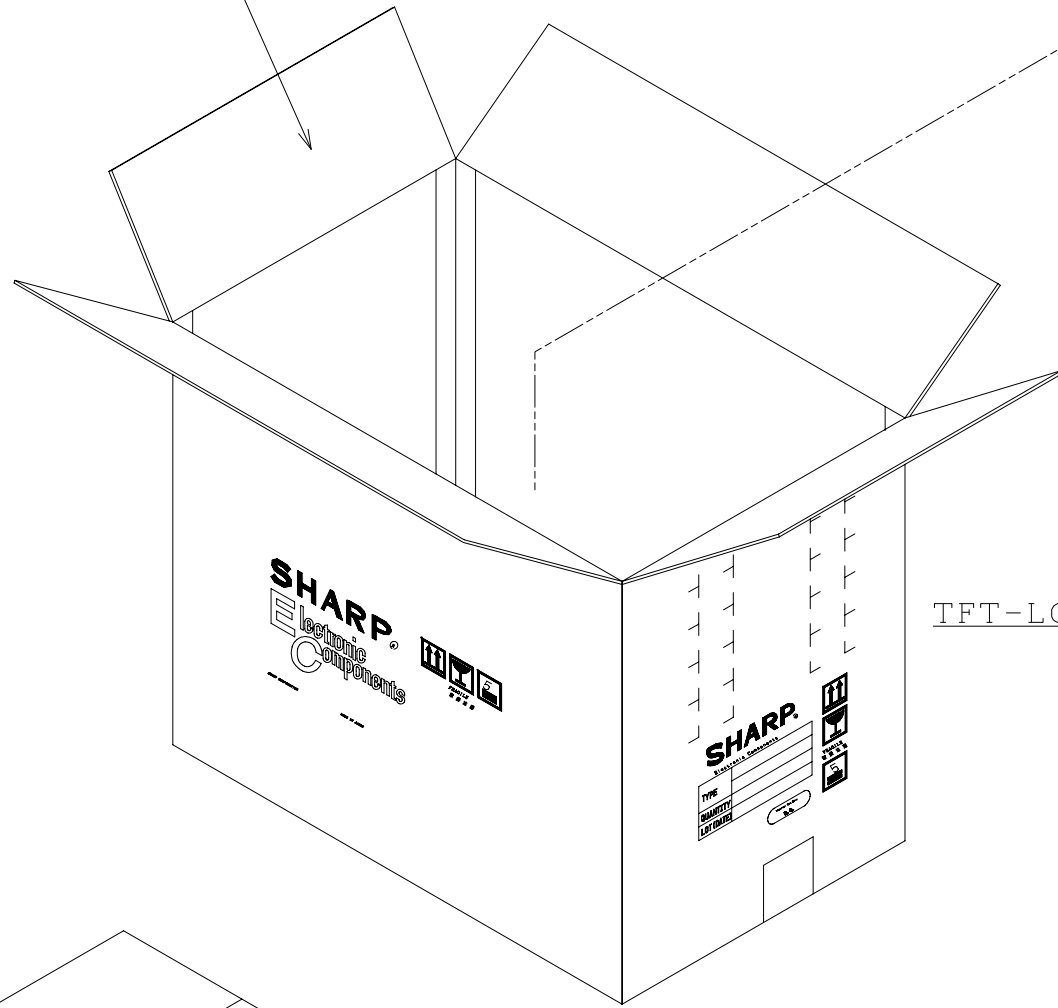

TFT-LCD MODULE

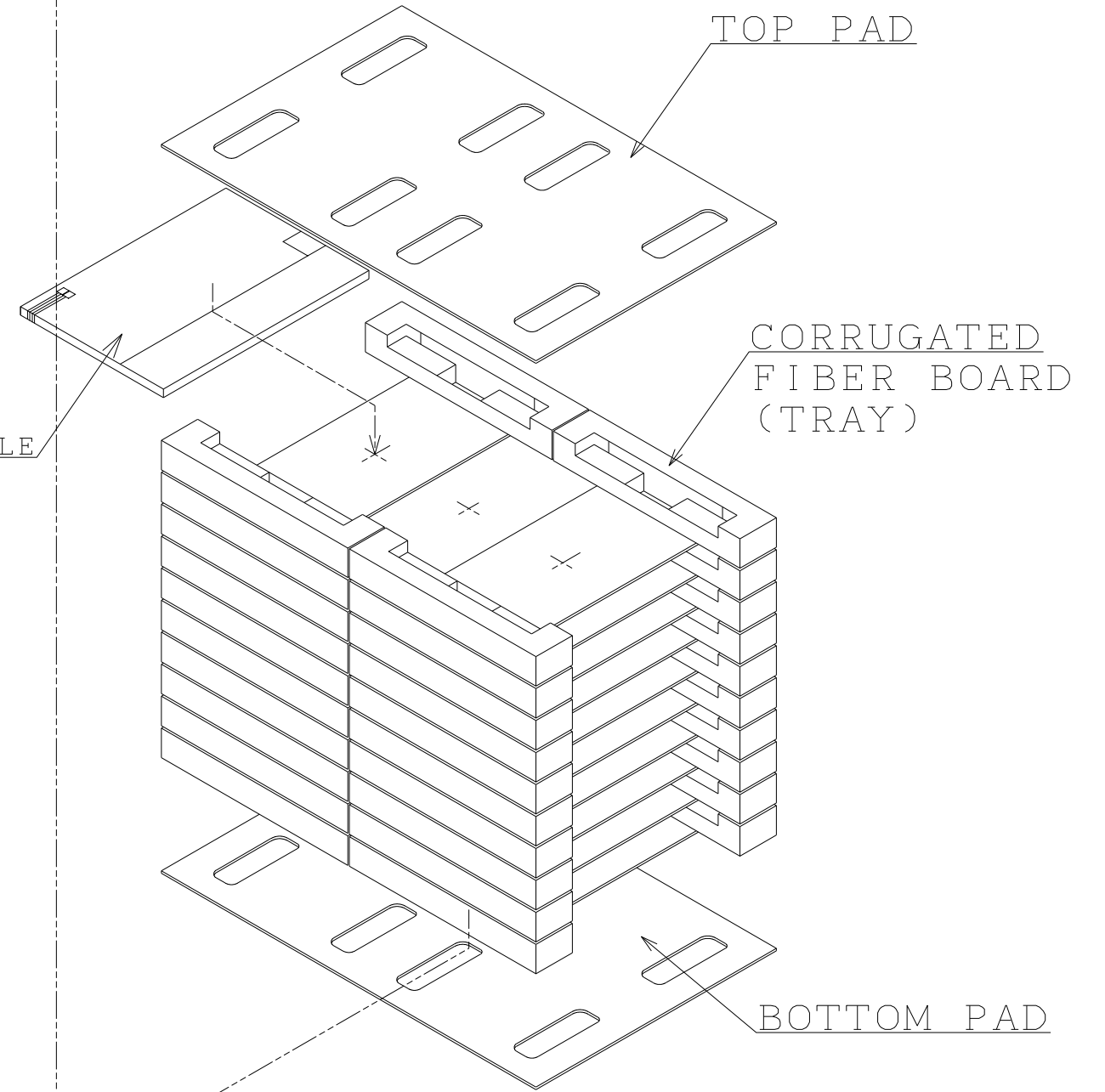

TOP PAD

CORRUGATED FIBER BOARD (TRAY)

BOTTOM PAD

OPP TAPE

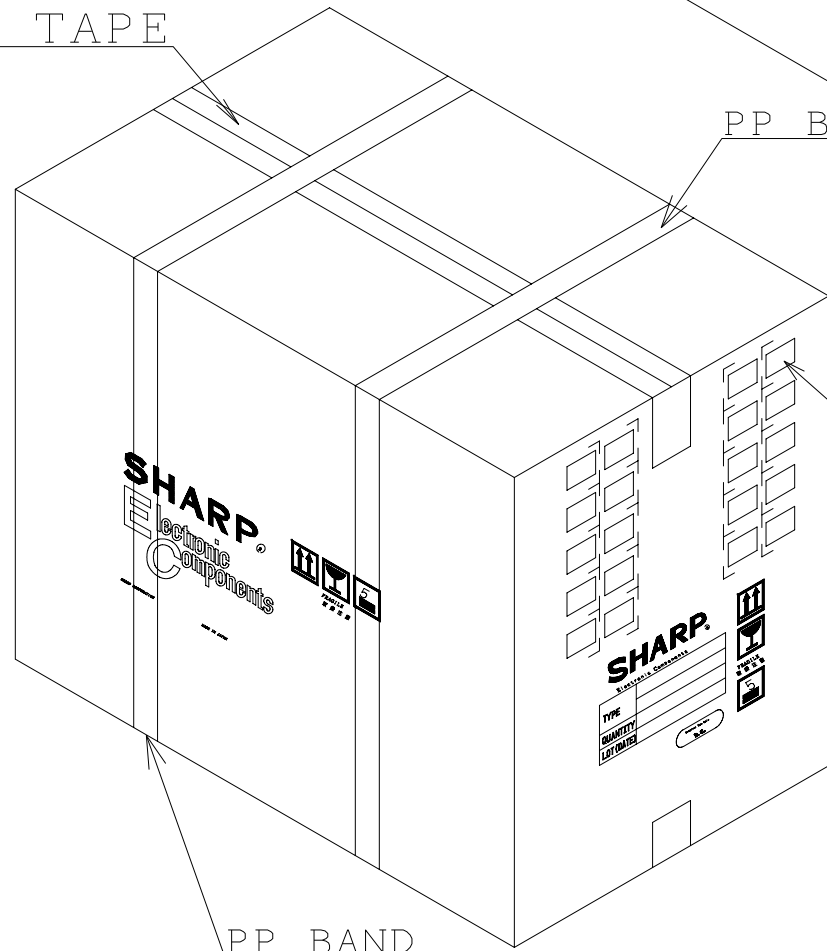

PP BAND

S/N LABEL

PP BAND

< PACKING FORM >

LCD Specification

LCD Group



NORTH AMERICA

Sharp Microelectronics of the Americas
5700 NW Pacific Rim Blvd.
Camas, WA 98607, U.S.A.
Phone: (1) 360-834-8700
Fax: (1) 360-834-8903
www.sharpsma.com

TAIWAN

Sharp Electronic Components
(Taiwan) Corporation
8F-A, No. 16, Sec. 4, Nanking E. Rd.
Taipei, Taiwan, Republic of China
Phone: (886) 2-2577-7341
Fax: (886) 2-2577-7326/2-2577-7328

CHINA

Sharp Microelectronics of China
(Shanghai) Co., Ltd.
28 Xin Jin Qiao Road King Tower 16F
Pudong Shanghai, 201206 P.R. China
Phone: (86) 21-5854-7710/21-5834-6056
Fax: (86) 21-5854-4340/21-5834-6057
Head Office:
No. 360, Bashen Road,
Xin Development Bldg. 22
Waigaoqiao Free Trade Zone Shanghai
200131 P.R. China
Email: smc@china.global.sharp.co.jp

EUROPE

Sharp Microelectronics Europe
Division of Sharp Electronics (Europe) GmbH
Sonninstrasse 3
20097 Hamburg, Germany
Phone: 49 (0)180 507 35 07
Fax: (49) 40-2376-2232
www.sharpsme.com

SINGAPORE

Sharp Electronics (Singapore) PTE., Ltd.
438A, Alexandra Road, #05-01/02
Alexandra Technopark,
Singapore 119967
Phone: (65) 271-3566
Fax: (65) 271-3855

KOREA

Sharp Electronic Components
(Korea) Corporation
RM 501 Geosung B/D, 541
Dohwa-dong, Mapo-ku
Seoul 121-701, Korea
Phone: (82) 2-711-5813 ~ 8
Fax: (82) 2-711-5819

JAPAN

Sharp Corporation
Electronic Components & Devices
22-22 Nagaïke-cho, Abeno-Ku
Osaka 545-8522, Japan
Phone: (81) 6-6621-1221
Fax: (81) 6117-725300/6117-725301
www.sharp-world.com

HONG KONG

Sharp-Roxy (Hong Kong) Ltd.
Level 26, Tower 1, Kowloon Commerce Centre,
No. 51, Kwai Cheong Road, Kwai Chung,
New Territories, Hong Kong
Phone: (852) 28229311
Fax: (852) 28660779
www.sharp.com.hk
Shenzhen Representative Office:
Room 602-603, 6/F,
International Chamber of Commerce Tower,
168 Fuhua Rd. 3, CBD,
Futian District, Shenzhen 518048,
Guangdong, P.R. China
Phone: (86) 755-88313505
Fax: (86) 755-88313515

SPECIFICATIONS ARE SUBJECT TO CHANGE WITHOUT NOTICE.

Suggested applications (if any) are for standard use; See Important Restrictions for limitations on special applications. See Limited Warranty for SHARP's product warranty.

The Limited Warranty is in lieu, and exclusive of, all other warranties, express or implied.

ALL EXPRESS AND IMPLIED WARRANTIES, INCLUDING THE WARRANTIES OF MERCHANTABILITY, FITNESS FOR USE AND FITNESS FOR A PARTICULAR PURPOSE, ARE SPECIFICALLY EXCLUDED. In no event will SHARP be liable, or responsible in any way, for any incidental or consequential economic or property damage.