

# MODEL TL-5935

International size reference: 1/6D, ER32L100

## TECHNICAL DATA

(Typical values @+25°C for batteries stored for one year or less)

■ Nominal capacity @ 1 mA, to 2V	1.7 Ah
■ Rated voltage	3.6 V
■ Maximum recommended continuous current	10 mA
■ Maximum pulse current capability	50 mA
■ Weight	21 g (0.74 oz)
■ Volume	8.2 cc
■ Operating temperature range	-55°C to +85°C
■ Li metal content	approx. 0.5 g
■ U.L. Component Recognition, MH 12193	

# TADIRAN LITHIUM BATTERIES

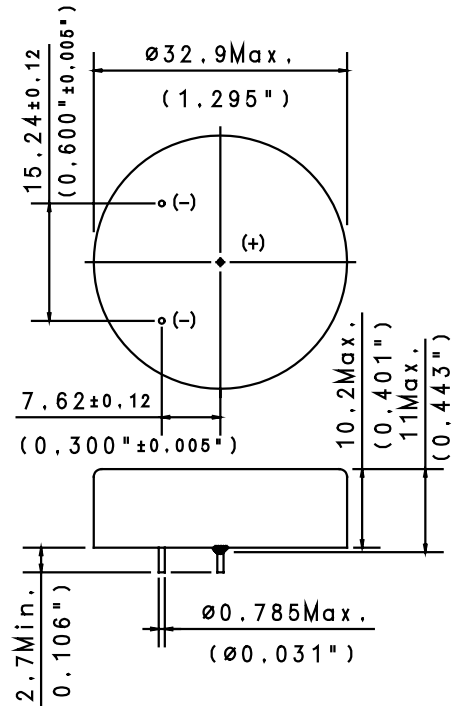

### ORDERING NO.

TERMINAL MATERIAL : TIN PLATED NICKEL  
CATALOGUE NO. : 15-5935-41500

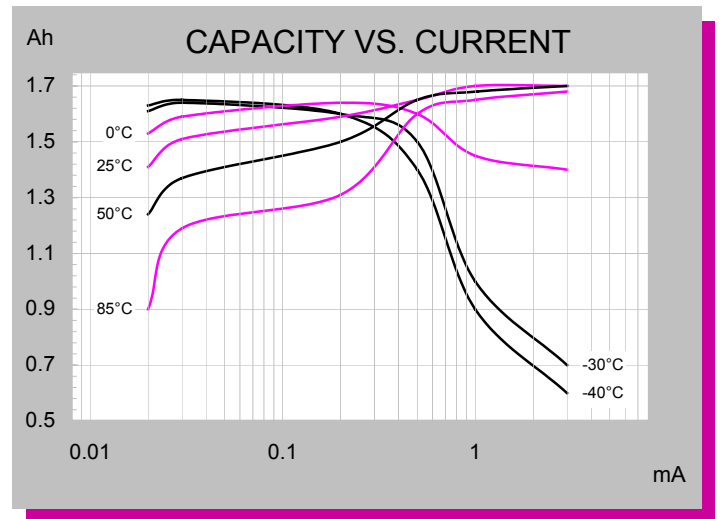
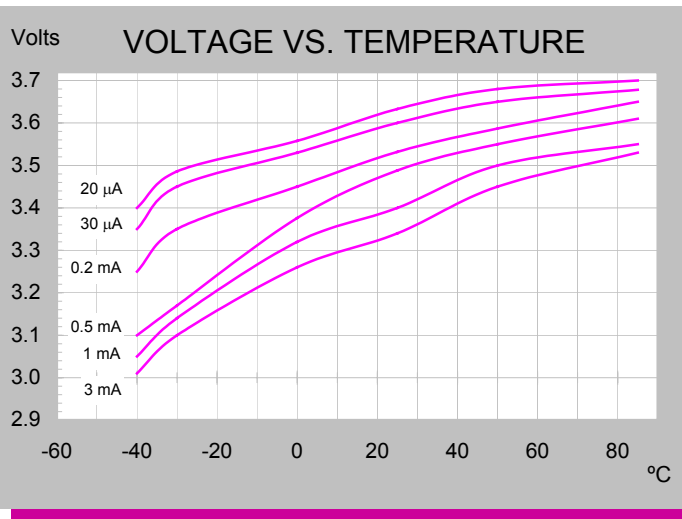
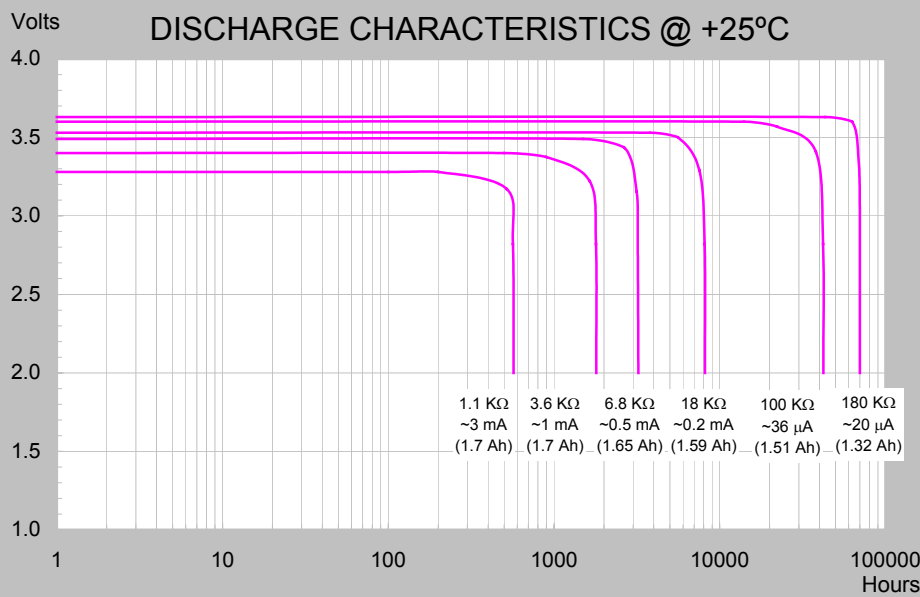

## iXtra - Long Term High Performance

Note: Any presentations in this data sheet concerning performance are for information purpose only and are not construed as warranties either expressed or implied, of future performance. Rev. A 11/05

# TL-5935

## CELL FEATURES

- 3.6 V Primary lithium-thionyl chloride (Li-SOCl<sub>2</sub>)
- Fast voltage recovery after long term storage and/or usage
- High energy density
- High and stable operating voltage
- Low self discharge rate
- 10 years shelf life
- Wafer construction
- Hermetic glass-to-metal-sealing
- Non-flammable electrolyte
- Non-restricted for transportation

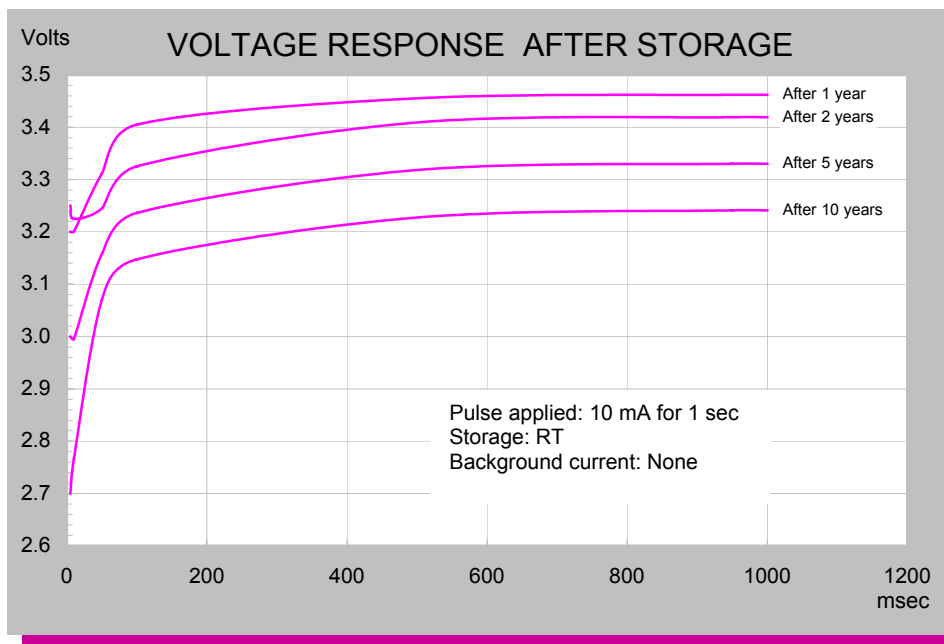

# TADIRAN LITHIUM BATTERIES

## MAIN APPLICATIONS

- Utility meters (elect., water & gas)
- Automatic meter reading
- RF systems
- Sensors & monitoring systems
- Tracking systems
- Wireless security systems
- Automotive electronics
- Industrial electronics
- Ultra Low Power (ULP) devices
- Others

## STORAGE CONDITIONS

- Cells should be stored in a clean & dry (less than 30 % RH) area
- Temp. should not exceed +30 °C

For updated information please visit our website [www.tadiranbat.com](http://www.tadiranbat.com)

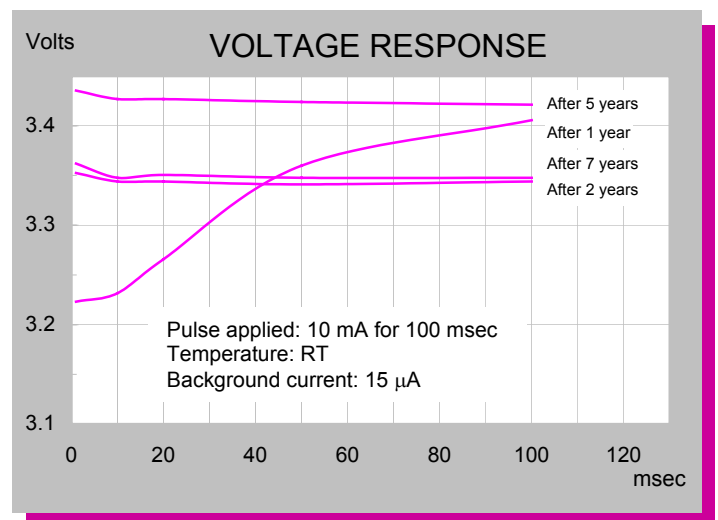
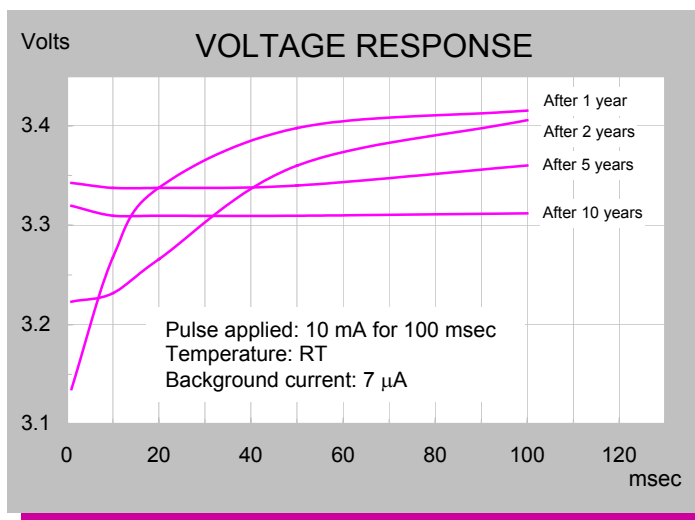

*iXtra - Long Term High Performance*

Note: Any presentations in this data sheet concerning performance are for information purpose only and are not construed as warranties either expressed or implied, of future performance. Rev. A 11/05