

$\overline{.006}$  ACROSS ALL SOLDER CHARGES

LEAD CODE  
1 = TIN  
2 = TIN/LEAD

DATE CODE

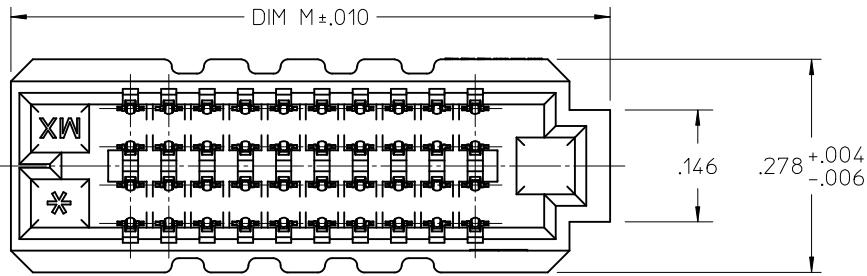

ROW 1 / CKT 1 ID

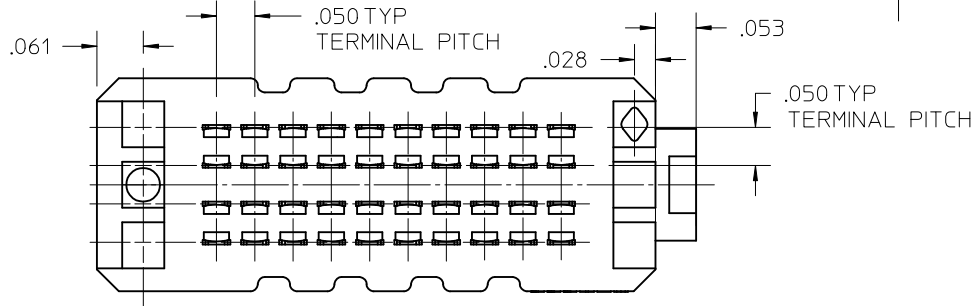
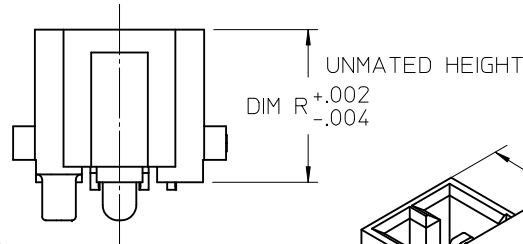
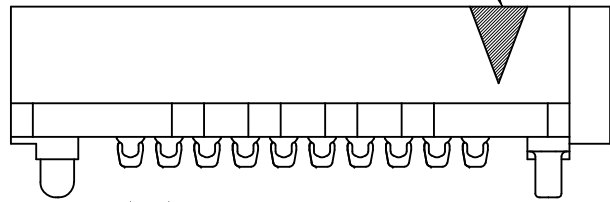

NOTES:

- MATERIALS: HOUSING- LCP, UL94V-0, BLACK  
CONTACTS- COPPER ALLOY  
SOLDER CHARGE: SEE CHART
- FINISH: ALL OPTIONS - SELECT GOLD IN CONTACT AREA: 30 MI MIN  
OPTIONS 5.0: SELECT GOLD FLASH IN TAIL, 7 MI MIN  
OPTIONS 6.0 THRU 8.0: SELECT TIN IN TAIL, 100 MI MIN  
ALL OPTIONS - OVER NICKEL
- PRODUCT SPECIFICATION: PS-45970-001
- PACKAGING SPECIFICATION: PK-45970-002
- MATES WITH SEARAY SLIM PLUG ASSY 46556
- APPLICATION SPECIFICATION: AS-45970-001
- COSMETIC SPECIFICATION: PS-45499-002 CLASS B
- PART STATUS: CONTACT MOLEX

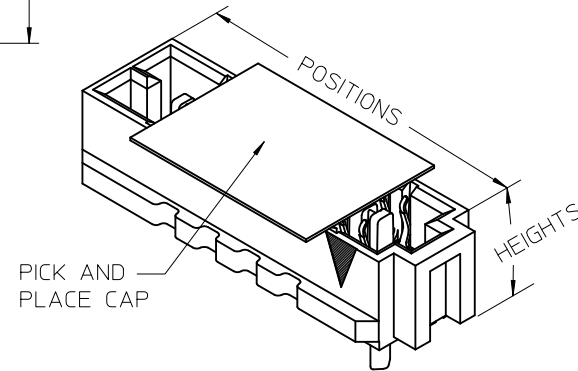

POSITION	DIM M	$\overline{.006}$
10	.782	.006
15	1.032	.006
20	1.282	.006
25	1.532	.006
30	1.782	.006
35	2.032	.006
40	2.282	.006
45	2.532	.009
50	2.782	.009

ADDED SOLDER COMP	DESCRIPTION
EC NO: UCP2011-2778	
DRWN: TGREGORI 2011/04/05	
CHKD: JCOMERCI	
APPR: JCOMERCI 2011/04/06	
K	REV

GENERAL TOLERANCES (UNLESS SPECIFIED)	
	mm INCH
4 PLACES	± --- ± ---
3 PLACES	± --- ± .005
2 PLACES	± --- ± ---
1 PLACE	± --- ± ---
ANGULAR ± ---°	
DRAFT WHERE APPLICABLE MUST REMAIN WITHIN DIMENSIONS	

DIMENSION STYLE INCH ONLY	
DRAWN BY	DATE
TGREGORI	2007/05/21
CHECKED BY	DATE
JCOMERCI	2007/05/21
APPROVED BY	DATE
JCOMERCI	2010/03/05
MATERIAL NO. SEE CHART	
SIZE	A

SCALE 4:1	DESIGN UNITS INCH	THIRD ANGLE PROJECTION
TITLE SEARAY SLIM RECEPTACLE ASSEMBLY .050 PITCH		
MOLEX INCORPORATED		
DOCUMENT NO. SD-46557-001		SHEET NO. 1 OF 4

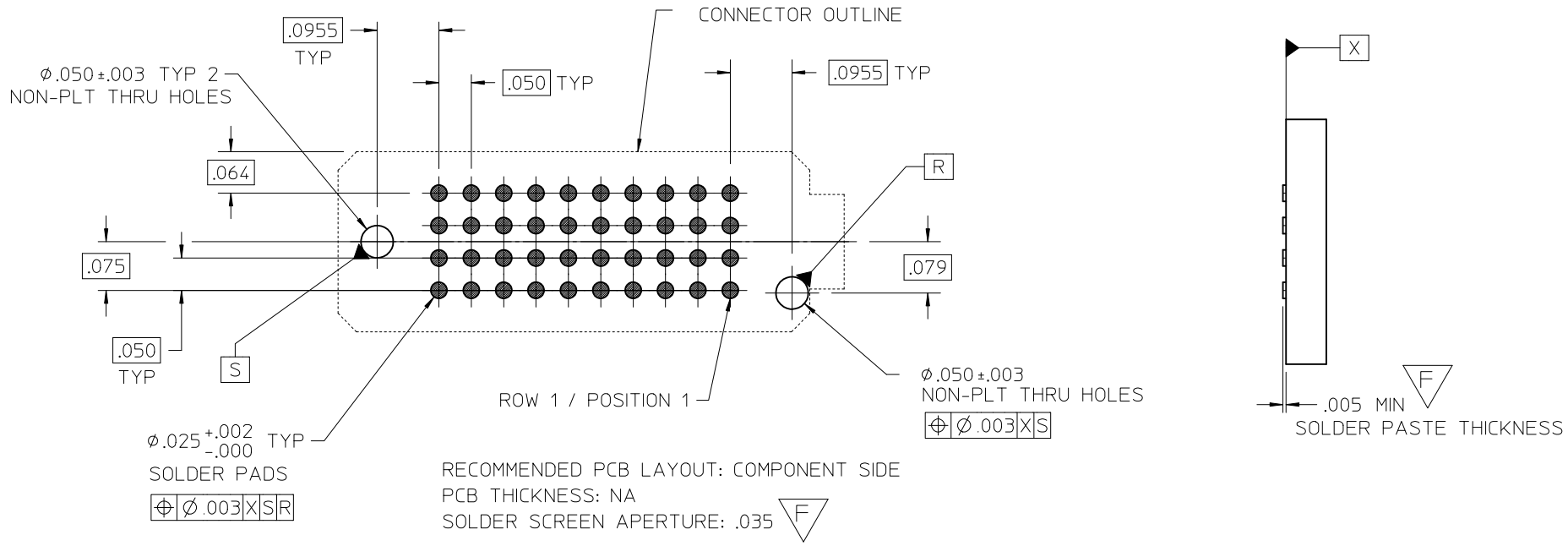

		DIM R RECEPTACLE STACK HEIGHT					
		MM	5.0	6.0	6.5	7.5	8.0
DIM P PLUG STACK HEIGHT	2.0	7.0	8.0	8.5	9.5	10.0	10.5
	3.0	8.0	9.0	9.5	10.5	11.0	11.5
	3.5	8.5	9.5	10.0	11.0	11.5	12.0
	2.5	7.5	8.5	9.0	10.0	10.5	11.0
	4.5	9.5	10.5	11.0	12.0	12.5	13.0
	5.0	10.0	11.0	11.5	12.5	13.0	13.5
	7.0	12.0	13.0	13.5	14.5	15.0	15.5

STACK HEIGHTS GIVEN IN MM FOR REF ONLY

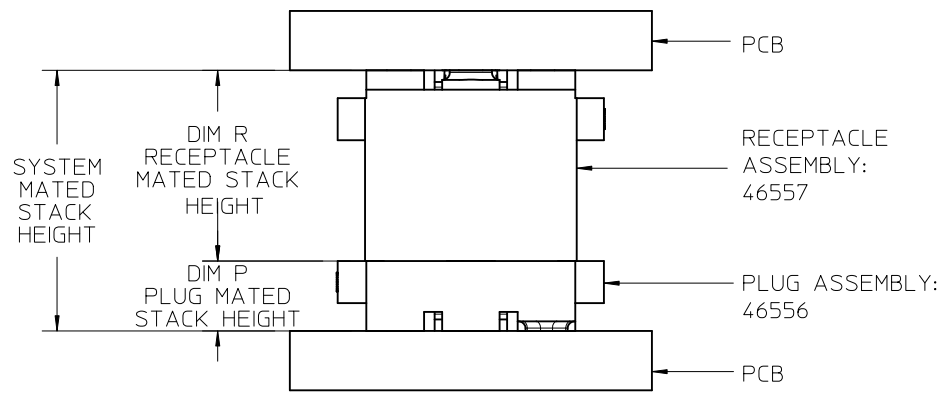

SEE SHEET 1  
EC NO: UCP2011-2778  
DRWN: TGREGOR 2011/04/05  
CHKD: JCOMERC 2011/04/06  
APPR: JCOMERC 2011/04/06

GENERAL TOLERANCES (UNLESS SPECIFIED)	
	mm INCH
4 PLACES	± .005 ± .0005
3 PLACES	± .005 ± .0005
2 PLACES	± .005 ± .0005
1 PLACE	± .005 ± .0005
ANGULAR ± .005°	
DRAFT WHERE APPLICABLE MUST REMAIN WITHIN DIMENSIONS	

DIMENSION STYLE INCH ONLY	
DRAWN BY	DATE
TGREGOR I	2007/05/21
CHECKED BY	DATE
JCOMERC I	2007/05/21
APPROVED BY	DATE
JCOMERC I	2010/03/05
MATERIAL NO.	
SEE CHART	

SCALE 4:1	DESIGN UNITS INCH	THIRD ANGLE PROJECTION
TITLE SEARAY SLIM RECEPTACLE ASSEMBLY .050 PITCH		
MOLEX INCORPORATED		
DOCUMENT NO. SD-46557-001		SHEET NO. 2 OF 4

	6	5	4	3	2	1
DIM R: (REF)	5.0 MM	6.0 MM	6.5 MM	7.5 MM	8.0 MM	STACK HEIGHTS GIVEN IN MM FOR REF ONLY
DIM R: HOUSING HEIGHT	.199	.238	.258	.297	.317	
POSITIONS	MATERIAL NO	MATERIAL NO	MATERIAL NO	MATERIAL NO	MATERIAL NO	
10	46557-1145	46557-1245	46557-1345	46557-1445	46557-1545	
20	46557-2145	46557-2245	46557-2345	46557-2445	46557-2545	
30	46557-3145	46557-3245	46557-3345	46557-3445	46557-3545	
40	46557-4145	46557-4245	46557-4345	46557-4445	46557-4545	
50	46557-5145	46557-5245	46557-5345	46557-5445	46557-5545	
15	46557-6145	46557-6245	46557-6345	46557-6445	46557-6545	
25	46557-7145	46557-7245	46557-7345	46557-7445	46557-7545	
35	46557-8145	46557-8245	46557-8345	46557-8445	46557-8545	
45	46557-9145	46557-9245	46557-9345	46557-9445	46557-9545	

NOTES:

- THIS SHEET CONTAINS THE FOLLOWING OPTIONS  
SOLDER CHARGE: TIN, 95.5/ Ag 3.8/ Cu 0.7

SEE SHEET 1 EC NO: UCP2011-2778 DRWN: TGREGORI 2011/04/05 CHKD: APPR: JCOMERCI 2011/04/06 REV DESCRIPTION	GENERAL TOLERANCES (UNLESS SPECIFIED)		DIMENSION STYLE <b>INCH ONLY</b>		SCALE <b>1:1</b>	DESIGN UNITS <b>INCH</b>	THIRD ANGLE PROJECTION		
		mm	INCH	DRAWN BY TGREGORI	DATE 2007/05/21	TITLE <b>SEARAY SLIM RECEPTACLE ASSEMBLY .050 PITCH</b>			
	4 PLACES	± ---	± ---	CHECKED BY JCOMERCI	DATE 2007/05/21				
	3 PLACES	± ---	± .005	APPROVED BY JCOMERCI	DATE 2010/03/05				
	2 PLACES	± ---	± ---	ANGULAR ± ---°		<b>MOLEX INCORPORATED</b>		MATERIAL NO. <b>SEE CHART</b>	
1 PLACE	± ---	± ---	DRAFT WHERE APPLICABLE MUST REMAIN WITHIN DIMENSIONS		DOCUMENT NO. <b>SD-46557-001</b>		SHEET NO. <b>3 OF 4</b>		

	6	5	4	3	2	1
DIM R: (REF)	5.0 MM	6.0 MM	6.5 MM	7.5 MM	8.0 MM	STACK HEIGHTS GIVEN IN MM FOR REF ONLY
DIM R: HOUSING HEIGHT	.199	.238	.258	.297	.317	
POSITIONS	MATERIAL NO	MATERIAL NO	MATERIAL NO	MATERIAL NO	MATERIAL NO	
10	46557-1147	46557-1247	46557-1347	46557-1447	46557-1547	
20	46557-2147	46557-2247	46557-2347	46557-2447	46557-2547	
30	46557-3147	46557-3247	46557-3347	46557-3447	46557-3547	
40	46557-4147	46557-4247	46557-4347	46557-4447	46557-4547	
50	46557-5147	46557-5247	46557-5347	46557-5447	46557-5547	
15	46557-6147	46557-6247	46557-6347	46557-6447	46557-6547	
25	46557-7147	46557-7247	46557-7347	46557-7447	46557-7547	
35	46557-8147	46557-8247	46557-8347	46557-8447	46557-8547	
45	46557-9147	46557-9247	46557-9347	46557-9447	46557-9547	

NOTES:

- THIS SHEET CONTAINS THE FOLLOWING OPTIONS  
SOLDER CHARGE: TIN / LEAD, 63/Pb 37

SEE SHEET 1 EC NO: UCP2011-2778 DRWN: TGREGORI 2011/04/05 CHKD: APPR: JCOMERCI 2011/04/06 REV DESCRIPTION	GENERAL TOLERANCES (UNLESS SPECIFIED)		DIMENSION STYLE <b>INCH ONLY</b>		SCALE <b>1:1</b>	DESIGN UNITS <b>INCH</b>	THIRD ANGLE PROJECTION	
		mm	INCH	DRAWN BY TGREGORI	DATE 2007/05/21	TITLE <b>SEARAY SLIM RECEPTACLE ASSEMBLY .050 PITCH</b>		
	4 PLACES	± .005	± .005	CHECKED BY JCOMERCI	DATE 2007/05/21			
	3 PLACES	± .005	± .005	APPROVED BY JCOMERCI	DATE 2010/03/05			
	2 PLACES	± .005	± .005	ANGULAR ± .005°		<b>MOLEX INCORPORATED</b> DOCUMENT NO. SD-46557-001		
1 PLACE	± .005	± .005	DRAFT WHERE APPLICABLE MUST REMAIN WITHIN DIMENSIONS		SHEET NO. 4 OF 4			
K	REV	SIZE <b>A</b>		THIS DRAWING CONTAINS INFORMATION THAT IS PROPRIETARY TO MOLEX INCORPORATED AND SHOULD NOT BE USED WITHOUT WRITTEN PERMISSION				