

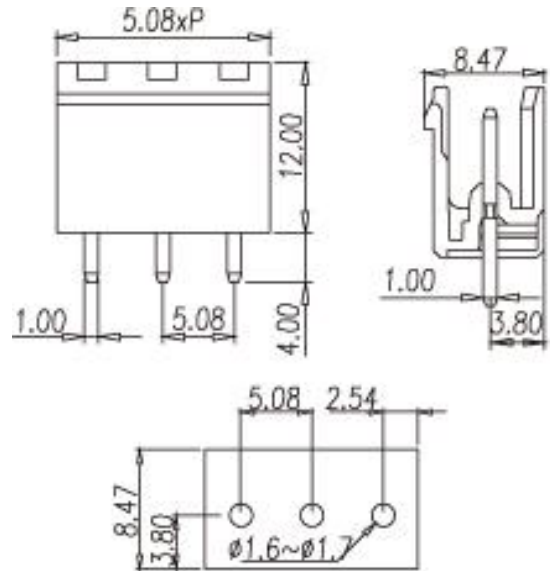

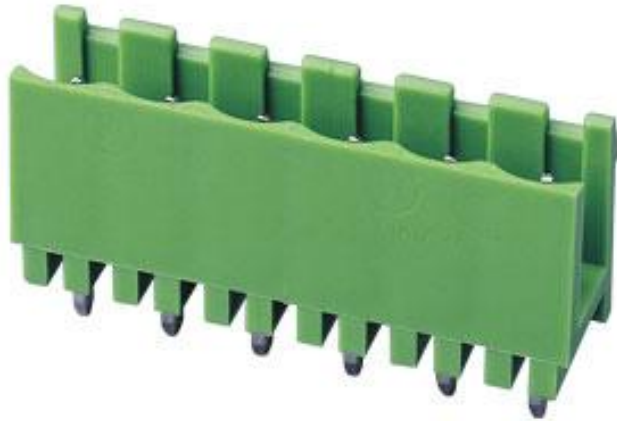

Headers(Sockets) for pluggable terminal blocks / ECH & EHD series



2EHDV



Pitch: 5.08mm

Approval	   	
Technical Data	UL	IEC
Rated voltage	300V	600V
Rated current	15A	18A
Conductor cross-section, solid (AWG/ mm ²)		
Conductor cross-section, flexible (AWG/ mm ²)		
Rated surge voltage (UL/IEC/Max.)	1.6 / 4 / 4KV	
Torque (N-m)		
Screw		
Wire strip length		
Pole	Cat. No.	
02	2EHDV-02P	
:	:	
:	:	
24	2EHDV-24P	

TEL: +886-2-2908-0614

FAX: +886-2-2908-8549

E-mail: info@dinkle.com.tw