

DATA SHEET

For a complete data sheet, please also download:

- The IC06 74HC/HCT/HCU/HCMOS Logic Family Specifications
- The IC06 74HC/HCT/HCU/HCMOS Logic Package Information
- The IC06 74HC/HCT/HCU/HCMOS Logic Package Outlines

74HC/HCT251 8-input multiplexer; 3-state

Product specification
File under Integrated Circuits, IC06

December 1990

8-input multiplexer; 3-state

74HC/HCT251

FEATURES

- True and complement outputs
- Both outputs are 3-state for further multiplexer expansion
- Multifunction capability
- Permits multiplexing from n-lines to one line
- Output capability: standard
- I_{CC} category: MSI

GENERAL DESCRIPTION

The 74HC/HCT251 are high-speed Si-gate CMOS devices and are pin compatible with low power Schottky TTL (LSTTL). They are specified in compliance with JEDEC standard no. 7A.

The 74HC/HCT251 are the logic implementations of single-pole 8-position switches with the state of three select inputs (S_0, S_1, S_2) controlling the switch positions. Assertion (Y) and negation (\bar{Y}) outputs are both provided. The output enable input (\bar{OE}) is active LOW. The logic function provided at the output, when activated, is:

$$Y = \bar{OE} \cdot (I_0 \cdot \bar{S}_0 \cdot \bar{S}_1 \cdot \bar{S}_2 + I_1 \cdot S_0 \cdot \bar{S}_1 \cdot \bar{S}_2 + I_2 \cdot \bar{S}_0 \cdot S_1 \cdot \bar{S}_2 + I_3 \cdot S_0 \cdot S_1 \cdot \bar{S}_2 + I_4 \cdot \bar{S}_0 \cdot \bar{S}_1 \cdot S_2 + I_5 \cdot S_0 \cdot \bar{S}_1 \cdot S_2 + I_6 \cdot \bar{S}_0 \cdot S_1 \cdot S_2 + I_7 \cdot S_0 \cdot S_1 \cdot S_2)$$

Both outputs are in the high impedance OFF-state (Z) when the output enable input is HIGH, allowing multiplexer expansion by tying the outputs.

QUICK REFERENCE DATA

GND = 0 V; T_{amb} = 25 °C; t_r = t_f = 6 ns

SYMBOL	PARAMETER	CONDITIONS	TYPICAL		UNIT
			HC	HCT	
t _{PHL} / t _{PLH}	propagation delay	C _L = 15 pF; V _{CC} = 5 V			
	I _n to Y		15	19	ns
	I _n to \bar{Y}		17	19	ns
	S _n to Y		20	20	ns
	S _n to \bar{Y}		21	21	ns
C _I	input capacitance		3.5	3.5	pF
C _{PD}	power dissipation capacitance per package	notes 1 and 2	44	46	pF

Notes

1. C_{PD} is used to determine the dynamic power dissipation (P_D in μW):

$$P_D = C_{PD} \times V_{CC}^2 \times f_i + \sum (C_L \times V_{CC}^2 \times f_o) \text{ where:}$$

f_i = input frequency in MHz

f_o = output frequency in MHz

∑ (C_L × V_{CC}² × f_o) = sum of outputs

C_L = output load capacitance in pF

V_{CC} = supply voltage in V

2. For HC the condition is V_I = GND to V_{CC}
For HCT the condition is V_I = GND to V_{CC} – 1.5 V

ORDERING INFORMATION

See "74HC/HCT/HCU/HCMOS Logic Package Information".

8-input multiplexer; 3-state

74HC/HCT251

PIN DESCRIPTION

PIN NO.	SYMBOL	NAME AND FUNCTION
4, 3, 2, 1, 15, 14, 13, 12	I_0 to I_7	multiplexer inputs
5	Y	multiplexer output
6	\bar{Y}	complementary multiplexer output
7	\overline{OE}	3-state output enable input (active LOW)
8	GND	ground (0 V)
11, 10, 9	S_0, S_1, S_2	select inputs
16	V_{CC}	positive supply voltage

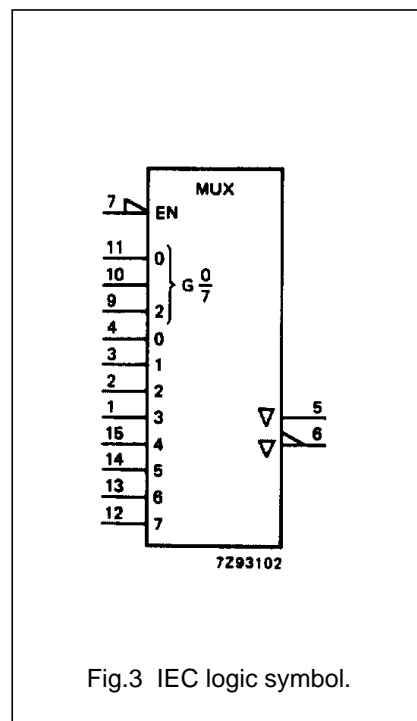
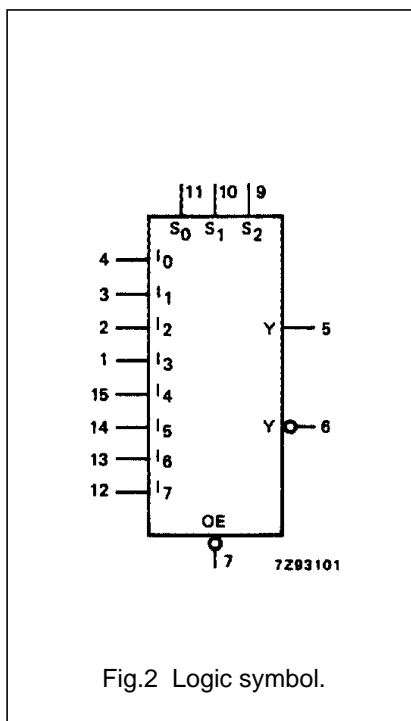
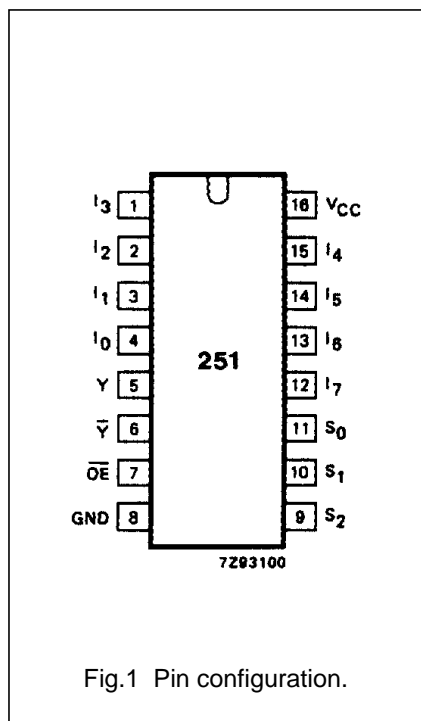

8-input multiplexer; 3-state

74HC/HCT251

FUNCTION TABLE

INPUTS												OUTPUTS	
\overline{OE}	S_2	S_1	S_0	I_0	I_1	I_2	I_3	I_4	I_5	I_6	I_7	\overline{Y}	Y
H	X	X	X	X	X	X	X	X	X	X	X	Z	Z
L	L	L	L	L	X	X	X	X	X	X	X	H	L
L	L	L	L	H	X	X	X	X	X	X	X	L	H
L	L	L	H	X	L	X	X	X	X	X	X	H	L
L	L	L	H	X	H	X	X	X	X	X	X	L	H
L	L	H	L	X	X	L	X	X	X	X	X	H	L
L	L	H	L	X	X	H	X	X	X	X	X	L	H
L	L	H	H	X	X	X	L	X	X	X	X	H	L
L	L	H	H	X	X	X	H	X	X	X	X	L	H
L	H	L	L	X	X	X	X	L	X	X	X	H	L
L	H	L	L	X	X	X	X	H	X	X	X	L	H
L	H	L	H	X	X	X	X	X	L	X	X	H	L
L	H	L	H	X	X	X	X	X	H	X	X	L	H
L	H	H	L	X	X	X	X	X	X	L	X	H	L
L	H	H	L	X	X	X	X	X	X	H	X	L	H
L	H	H	H	X	X	X	X	X	X	X	L	H	L
L	H	H	H	X	X	X	X	X	X	X	H	L	H

Note

- H = HIGH voltage level
L = LOW voltage level
X = don't care
Z = high impedance OFF-state

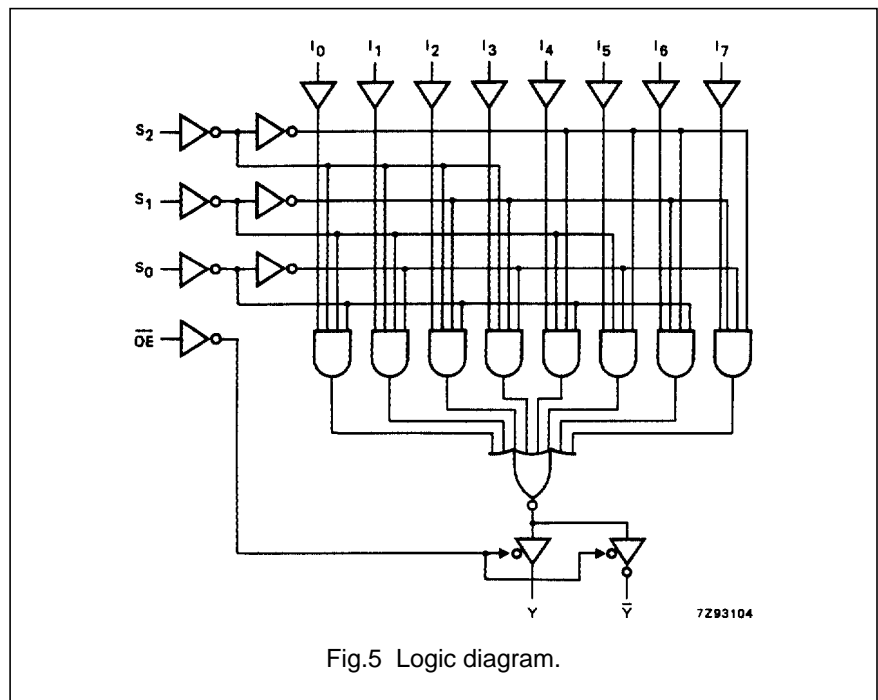
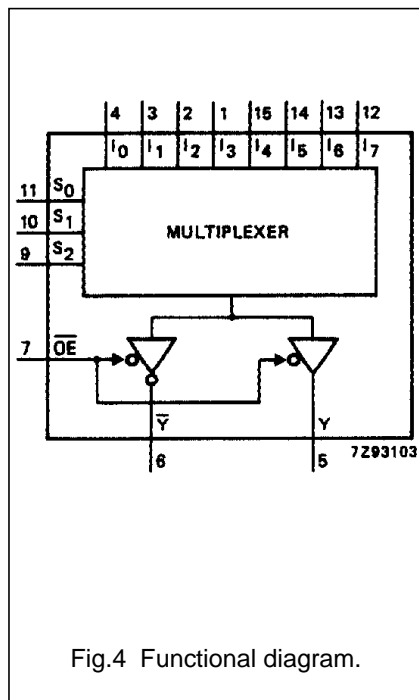

8-input multiplexer; 3-state

74HC/HCT251

DC CHARACTERISTICS FOR 74HC

For the DC characteristics see *"74HC/HCT/HCU/HCMOS Logic Family Specifications"*.

Output capability: standard

I_{CC} category: MSI

AC CHARACTERISTICS FOR 74HC

GND = 0 V; t_r = t_f = 6 ns; C_L = 50 pF

SYMBOL	PARAMETER	T _{amb} (°C)						UNIT	TEST CONDITIONS		
		74HC							V _{CC} (V)	WAVEFORMS	
		+25			-40 to +85		-40 to +125				
		min.	typ.	max.	min.	max.	min.				max.
t _{PHL} / t _{PLH}	propagation delay I _n to Y		50 18 14	170 34 29		215 43 37		255 51 43	ns	2.0 4.5 6.0	Fig.6
t _{PHL} / t _{PLH}	propagation delay I _n to \bar{Y}		55 20 16	175 35 30		220 44 37		265 53 45	ns	2.0 4.5 6.0	Fig.7
t _{PHL} / t _{PLH}	propagation delay S _n to Y		66 24 19	205 41 35		255 51 43		310 62 53	ns	2.0 4.5 6.0	Fig.6
t _{PHL} / t _{PLH}	propagation delay S _n to \bar{Y}		69 25 20	205 41 35		255 51 43		310 62 53	ns	2.0 4.5 6.0	Fig.7
t _{PZH} / t _{PZL}	3-state output enable time \overline{OE} to Y, \bar{Y}		36 13 10	140 28 24		175 35 30		210 42 36	ns	2.0 4.5 6.0	Fig.7
t _{PHZ} / t _{PLZ}	3-state output disable time \overline{OE} to Y, \bar{Y}		39 14 11	140 28 24		170 35 30		210 42 36	ns	2.0 4.5 6.0	Fig.7
t _{THL} / t _{TLH}	output transition time		19 7 6	75 15 13		95 19 16		110 22 19	ns	2.0 4.5 6.0	Figs 6 and 7

8-input multiplexer; 3-state

74HC/HCT251

DC CHARACTERISTICS FOR 74HCT

For the DC characteristics see *"74HC/HCT/HCU/HCMOS Logic Family Specifications"*.

Output capability: standard

I_{CC} category: MSI

Note to HCT types

The value of additional quiescent supply current (ΔI_{CC}) for a unit load of 1 is given in the family specifications. To determine ΔI_{CC} per input, multiply this value by the unit load coefficient shown in the table below.

INPUT	UNIT LOAD COEFFICIENT
I _n	1.00
S ₀	1.50
S ₁ , S ₂	1.50
\overline{OE}	1.50

AC CHARACTERISTICS FOR HCT

GND = 0 V; t_r = t_f = 6 ns; C_L = 50 pF

SYMBOL	PARAMETER	T _{amb} (°C)							UNIT	TEST CONDITIONS	
		74HCT								V _{CC} (V)	WAVEFORMS
		+25			-40 to +85		-40 to +125				
		min.	typ.	max.	min.	max.	min.	max.			
t _{PHL} / t _{PLH}	propagation delay I _n to Y		22	35		44		53	ns	4.5	Fig.6
t _{PHL} / t _{PLH}	propagation delay I _n to \overline{Y}		22	35		44		53	ns	4.5	Fig.7
t _{PHL} / t _{PLH}	propagation delay S _n to Y		24	44		55		66	ns	4.5	Fig.6
t _{PHL} / t _{PLH}	propagation delay S _n to \overline{Y}		25	44		55		66	ns	4.5	Fig.7
t _{PZH} / t _{PZL}	3-state output enable time \overline{OE} to Y, \overline{Y}		13	28		35		42	ns	4.5	Fig.7
t _{PHZ} / t _{PLZ}	3-state output disable time \overline{OE} to Y, \overline{Y}		14	28		35		42	ns	4.5	Fig.7
t _{THL} / t _{TLH}	output transition time		7	15		19		22	ns	4.5	Figs 6 and 7

8-input multiplexer; 3-state

74HC/HCT251

AC WAVEFORMS

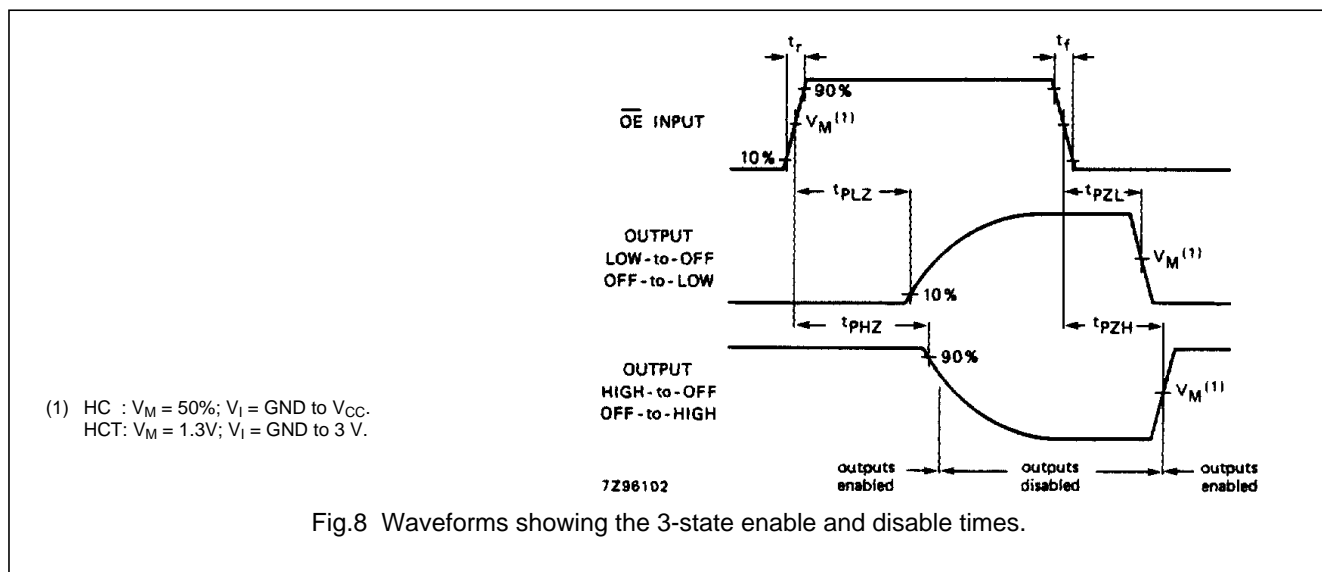
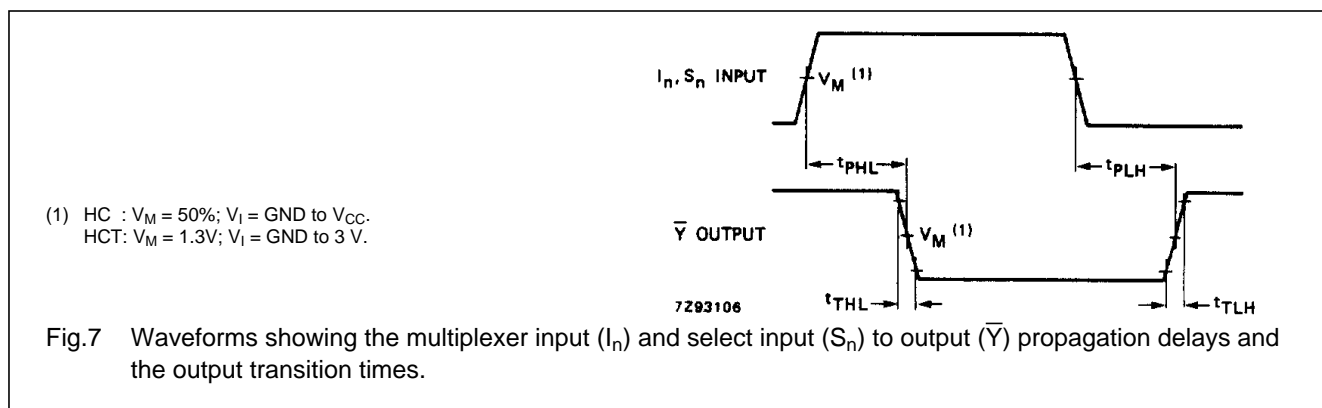
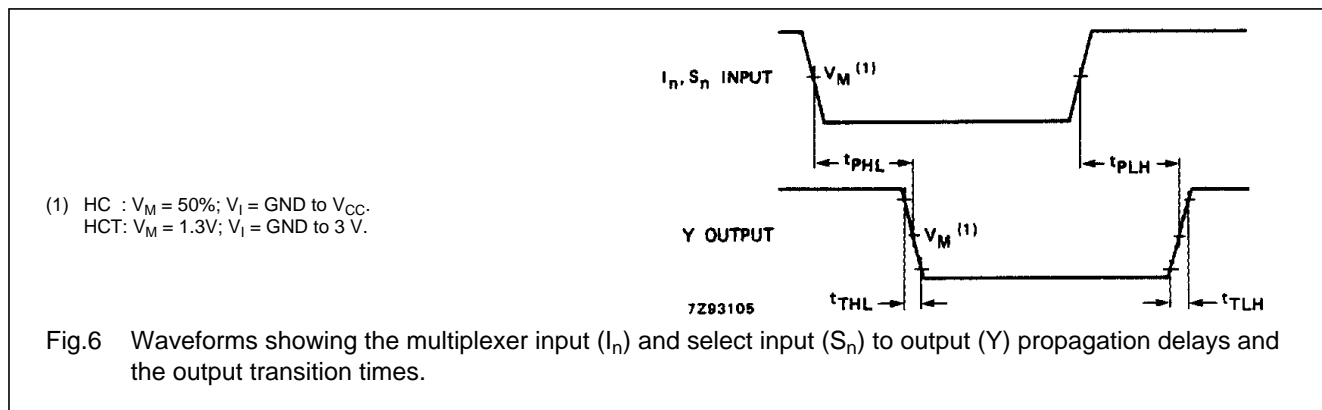

PACKAGE OUTLINES

See "74HC/HCT/HCU/HCMOS Logic Package Outlines".

This datasheet has been download from:

www.datasheetcatalog.com

Datasheets for electronics components.