

TPS7201Q, TPS7225Q, TPS7230Q
 TPS7233Q, TPS7248Q, TPS7250Q, TPS72xxY
MICROPOWER LOW-DROPOUT (LDO) VOLTAGE REGULATORS

SLVS102G – MARCH 1995 – REVISED JUNE 2000

- Available in 5-V, 4.85-V, 3.3-V, 3.0-V, and 2.5-V Fixed-Output and Adjustable Versions
- Dropout Voltage <85 mV Max at $I_O = 100$ mA (TPS7250)
- Low Quiescent Current, Independent of Load, 180 μ A Typ
- 8-Pin SOIC and 8-Pin TSSOP Package
- Output Regulated to $\pm 2\%$ Over Full Operating Range for Fixed-Output Versions
- Extremely Low Sleep-State Current, 0.5 μ A Max
- Power-Good (PG) Status Output

description

The TPS72xx family of low-dropout (LDO) voltage regulators offers the benefits of low-dropout voltage, micropower operation, and miniaturized packaging. These regulators feature extremely low dropout voltages and quiescent currents compared to conventional LDO regulators. Offered in small-outline integrated-circuit (SOIC) packages and 8-terminal thin shrink small-outline (TSSOP), the TPS72xx series devices are ideal for cost-sensitive designs and for designs where board space is at a premium.

A combination of new circuit design and process innovation has enabled the usual pnp pass transistor to be replaced by a PMOS device. Because the PMOS pass element behaves as a low-value resistor, the dropout voltage is very low – maximum of 85 mV at 100 mA of load current (TPS7250) – and is directly proportional to the load current (see Figure 1). Since the PMOS pass element is a voltage-driven device, the quiescent current is very low (300 μ A maximum) and is stable over the entire range of output load current (0 mA to 250 mA). Intended for use in portable systems such as laptops and cellular phones, the low-dropout voltage and micropower operation result in a significant increase in system battery operating life.

The TPS72xx also features a logic-enabled sleep mode to shut down the regulator, reducing quiescent current to 0.5 μ A maximum at $T_J = 25^\circ\text{C}$. Other features include a power-good function that reports low output voltage and may be used to implement a power-on reset or a low-battery indicator.

The TPS72xx is offered in 2.5-V, 3-V, 3.3-V, 4.85-V, and 5-V fixed-voltage versions and in an adjustable version (programmable over the range of 1.2 V to 9.75 V). Output voltage tolerance is specified as a maximum of 2% over line, load, and temperature ranges (3% for adjustable version).

**D, P, OR PW PACKAGE
(TOP VIEW)**

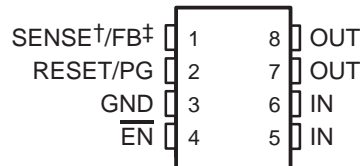

† SENSE – Fixed voltage options only (TPS7225, TPS7230, TPS7233, TPS7248, and TPS7250)

‡ FB – Adjustable version only (TPS7201)

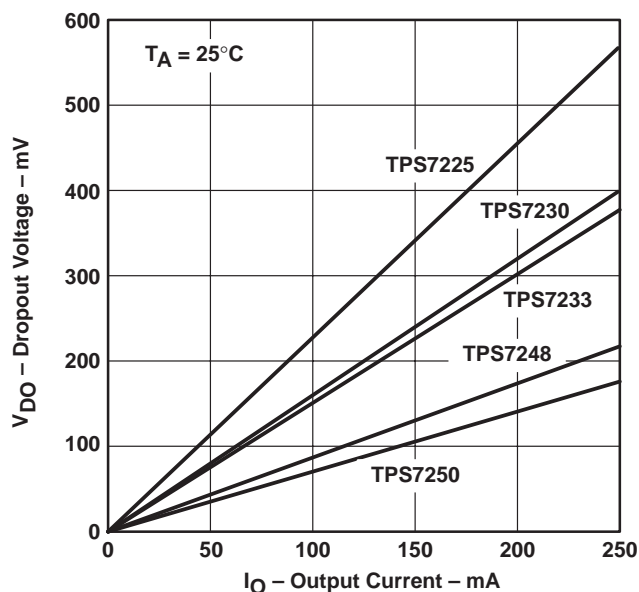

Figure 1. Typical Dropout Voltage Versus Output Current



Please be aware that an important notice concerning availability, standard warranty, and use in critical applications of Texas Instruments semiconductor products and disclaimers thereto appears at the end of this data sheet.

PRODUCTION DATA information is current as of publication date. Products conform to specifications per the terms of Texas Instruments standard warranty. Production processing does not necessarily include testing of all parameters.



POST OFFICE BOX 655303 • DALLAS, TEXAS 75265

Copyright © 2000, Texas Instruments Incorporated

TPS7201Q, TPS7225Q, TPS7230Q
 TPS7233Q, TPS7248Q, TPS7250Q, TPS72xxY
 MICROPOWER LOW-DROPOUT (LDO) VOLTAGE REGULATORS

SLVS102G – MARCH 1995 – REVISED JUNE 2000

AVAILABLE OPTIONS

| T _J | OUTPUT VOLTAGE (V) | | | PACKAGED DEVICES | | | CHIP FORM (Y) |
|----------------|-------------------------------|------|------|-------------------|-----------|-------------|---------------|
| | MIN | TYP | MAX | SMALL OUTLINE (D) | PDIP (P) | TSSOP (PW) | |
| -55°C to 150°C | 4.9 | 5 | 5.1 | TPS7250QD | TPS7250QP | TPS7250QPWR | TPS7250Y |
| | 4.75 | 4.85 | 4.95 | TPS7248QD | TPS7248QP | TPS7248QPWR | TPS7248Y |
| | 3.23 | 3.3 | 3.37 | TPS7233QD | TPS7233QP | TPS7233QPWR | TPS7233Y |
| | 2.94 | 3 | 3.06 | TPS7230QD | TPS7230QP | TPS7230QPWR | TPS7230Y |
| | 2.45 | 2.5 | 2.55 | TPS7225QD | TPS7225QP | TPS7225QPWR | TPS7225Y |
| | Adjustable 1.2 V to 9.75 V | | | TPS7201QD | TPS7201QP | TPS7201QPWR | TPS7201Y |

The D package is available taped and reeled. Add R suffix to device type (e.g., TPS7250QDR). The PW package is only available left-end taped and reeled. The TPS7201Q is programmable using an external resistor divider (see application information). The chip form is tested at 25°C.

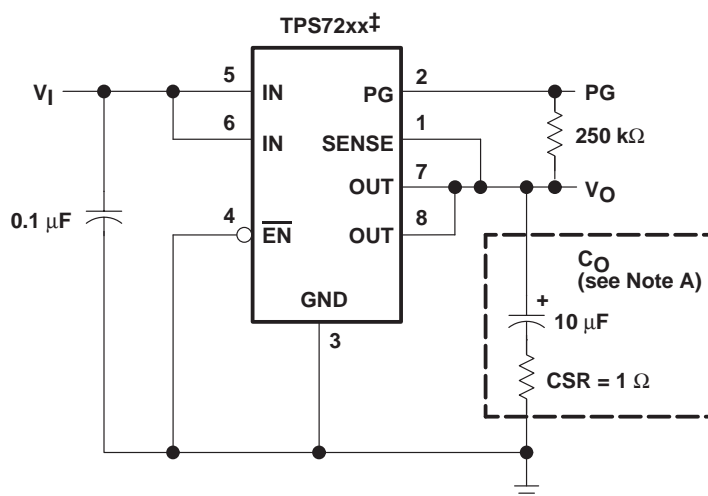

‡ TPS7225Q, TPS7230Q, TPS7233Q, TPS7248Q, TPS7250Q (fixed-voltage options)

NOTE A: Capacitor selection is nontrivial. See application information section for details.

Figure 2. Typical Application Configuration

**TPS7201Q, TPS7225Q, TPS7230Q
TPS7233Q, TPS7248Q, TPS7250Q, TPS72xxY
MICROPOWER LOW-DROPOUT (LDO) VOLTAGE REGULATORS**

SLVS102G – MARCH 1995 – REVISED JUNE 2000

TPS72xx chip information

These chips, when properly assembled, display characteristics similar to the TPS72xxQ. Thermal compression or ultrasonic bonding may be used on the doped aluminum bonding pads. The chips may be mounted with conductive epoxy or a gold-silicon preform.

BONDING PAD ASSIGNMENTS

57
69

TPS72xx

(1) GND

IN (3) EN (2)

(5) SENSE† (6) FB‡

(4) OUT (7) PG

CHIP THICKNESS: 15 MILS TYPICAL

BONDING PADS: 4 × 4 MILS MINIMUM

T_{jmax} = 150°C

TOLERANCES ARE ±10%.

ALL DIMENSIONS ARE IN MILS.

† Fixed-voltage options only (TPS7225, TPS7230, TPS7233, TPS7248, and TPS7250)

‡ Adjustable version only (TPS7201)

NOTE A. For most applications, OUT and SENSE should be tied together as close as possible to the device; for other implementations, refer to the SENSE-pin connection discussion in the application information section of this data sheet.

functional block diagram

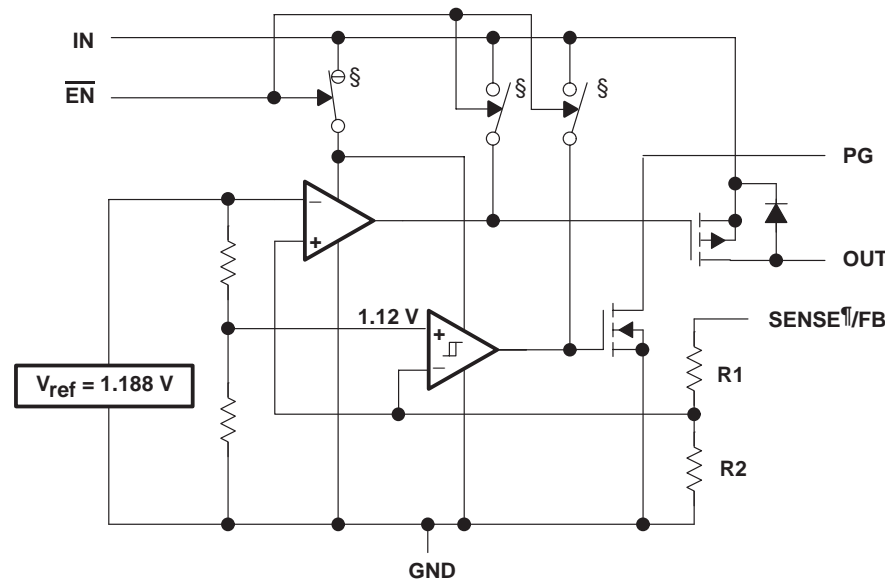

RESISTOR DIVIDER OPTIONS

| DEVICE | R1 | R2 | UNIT |
|---------|-----|-----|------|
| TPS7201 | 0 | ∞ | Ω |
| TPS7225 | 257 | 233 | kΩ |
| TPS7230 | 357 | 233 | kΩ |
| TPS7233 | 420 | 233 | kΩ |
| TPS7248 | 726 | 233 | kΩ |
| TPS7250 | 756 | 233 | kΩ |

NOTE A: Resistors are nominal values only.

COMPONENT COUNT

| | |
|---------------------|-----|
| MOS transistors | 108 |
| Bipolar transistors | 41 |
| Diodes | 4 |
| Capacitors | 15 |
| Resistors | 75 |

§ Switch positions are shown with EN low (active).

¶ For most applications, SENSE should be externally connected to OUT as close as possible to the device. For other implementations, refer to the SENSE-pin connection discussion in application information section.

**TPS7201Q, TPS7225Q, TPS7230Q
 TPS7233Q, TPS7248Q, TPS7250Q, TPS72xxY
 MICROPOWER LOW-DROPOUT (LDO) VOLTAGE REGULATORS**

SLVS102G – MARCH 1995 – REVISED JUNE 2000

absolute maximum ratings over operating free-air temperature range (unless otherwise noted)†

| | |
|--|---------------------------------------|
| Input voltage range‡, V_I , PG, SENSE, \overline{EN} | –0.3 V to 11 V |
| Output current, I_O | 1.5 A |
| Continuous total power dissipation | See Dissipation Rating Tables 1 and 2 |
| Operating virtual junction temperature range, T_J | –55°C to 150°C |
| Storage temperature range, T_{stg} | –65°C to 150°C |
| Lead temperature 1,6 mm (1/16 inch) from case for 10 seconds | 260°C |

† Stresses beyond those listed under “absolute maximum ratings” may cause permanent damage to the device. These are stress ratings only, and functional operation of the device at these or any other conditions beyond those indicated under “recommended operating conditions” is not implied. Exposure to absolute-maximum-rated conditions for extended periods may affect device reliability.

‡ All voltage values are with respect to network ground terminal.

DISSIPATION RATING TABLE 1 – FREE-AIR TEMPERATURE (see Note 1 and Figure 3)

| PACKAGE | $T_A \leq 25^\circ\text{C}$ POWER RATING | DERATING FACTOR ABOVE $T_A = 25^\circ\text{C}$ | $T_A = 70^\circ\text{C}$ POWER RATING | $T_A = 85^\circ\text{C}$ POWER RATING | $T_A = 125^\circ\text{C}$ POWER RATING |
|---------|---|---|--|--|---|
| D | 725 mW | 5.8 mW/°C | 464 mW | 377 mW | 145 mW |
| P | 1175 mW | 8.74 mW/°C | 782 mW | 650 mW | 301 mW |
| PW | 525 mW | 4.2 mW/°C | 336 mW | 273 mW | 105 mW |

DISSIPATION RATING TABLE 2 – CASE TEMPERATURE (see Note 1 and Figure 4)

| PACKAGE | $T_C \leq 25^\circ\text{C}$ POWER RATING | DERATING FACTOR ABOVE $T_C = 25^\circ\text{C}$ | $T_C = 70^\circ\text{C}$ POWER RATING | $T_C = 85^\circ\text{C}$ POWER RATING | $T_C = 125^\circ\text{C}$ POWER RATING |
|---------|---|---|--|--|---|
| D | 2063 mW | 16.5 mW/°C | 1320 mW | 1073 mW | 413 mW |
| P | 2738 mW | 20.49 mW/°C | 1816 mW | 1508 mW | 689 mW |
| PW | 2900 mW | 23.2 mW/°C | 1856 mW | 1508 mW | 580 mW |

NOTE 1: Dissipation rating tables and figures are provided for maintenance of junction temperature at or below absolute maximum of 150°C. For guidelines on maintaining junction temperature within the recommended operating range, see application information section.

**MAXIMUM CONTINUOUS DISSIPATION
 vs
 FREE-AIR TEMPERATURE**

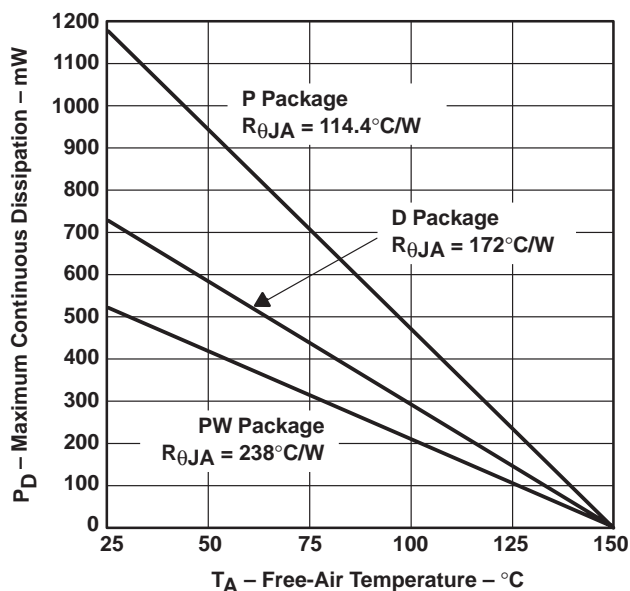

Figure 3

**MAXIMUM CONTINUOUS DISSIPATION
 vs
 CASE TEMPERATURE**

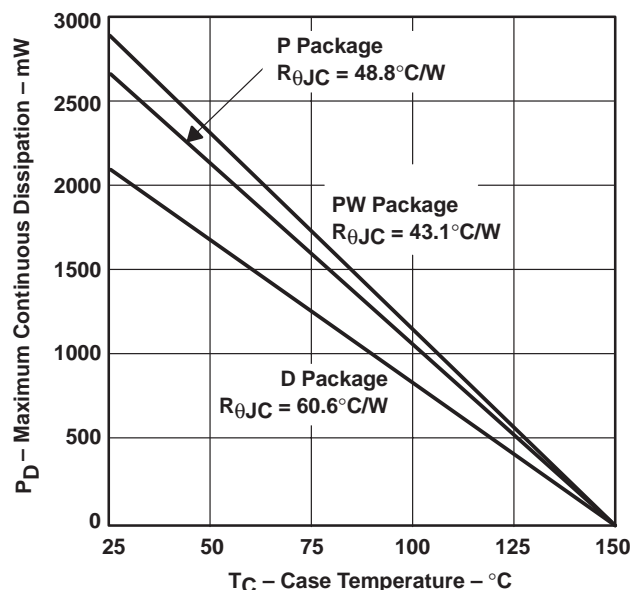

Figure 4



TPS7201Q, TPS7225Q, TPS7230Q
 TPS7233Q, TPS7248Q, TPS7250Q, TPS72xxY
MICROPOWER LOW-DROPOUT (LDO) VOLTAGE REGULATORS
 SLVS102G – MARCH 1995 – REVISED JUNE 2000

recommended operating conditions

| | | MIN | MAX | UNIT |
|--|----------|------|-----|------|
| Input voltage, V_I^\dagger | TPS7201Q | 3 | 10 | V |
| | TPS7225Q | 3.65 | 10 | |
| | TPS7230Q | 3.96 | 10 | |
| | TPS7233Q | 3.98 | 10 | |
| | TPS7248Q | 5.24 | 10 | |
| | TPS7250Q | 5.41 | 10 | |
| High-level input voltage at \overline{EN} , V_{IH} | | 2 | | V |
| Low-level input voltage at \overline{EN} , V_{IL} | | | 0.5 | V |
| Output current, I_O | | 0 | 250 | mA |
| Operating virtual junction temperature, T_J | | -40 | 125 | °C |

† Minimum input voltage defined in the recommended operating conditions is the maximum specified output voltage plus dropout voltage at the maximum specified load range. Since dropout voltage is a function of output current, *the usable range can be extended for lighter loads*. To calculate the minimum input voltage for the maximum load current used in a given application, use the following equation:

$$V_{I(\min)} = V_{O(\max)} + V_{DO(\max \text{ load})}$$

Because the TPS7201 is programmable, $r_{DS(on)}$ should be used to calculate V_{DO} before applying the above equation. The equation for calculating V_{DO} from $r_{DS(on)}$ is given in Note 3 under the TPS7201 electrical characteristics table. The minimum value of 3 V is the absolute lower limit for the recommended input-voltage range for the TPS7201.

TPS7201Q, TPS7225Q, TPS7230Q
 TPS7233Q, TPS7248Q, TPS7250Q, TPS72xxY
 MICROPOWER LOW-DROPOUT (LDO) VOLTAGE REGULATORS

SLVS102G – MARCH 1995 – REVISED JUNE 2000

electrical characteristics, $I_O = 10 \text{ mA}$, $\overline{EN} = 0 \text{ V}$, $C_O = 4.7 \mu\text{F}$ ($\text{CSR}^\dagger = 1 \Omega$), SENSE/FB shorted to OUT (unless otherwise noted)

| PARAMETER | TEST CONDITIONS‡ | T _J | TPS72xxQ | | | UNIT |
|--|--|-------------------------------------|----------|-----|--------|------|
| | | | MIN | TYP | MAX | |
| Ground current (active mode) | $EN \leq 0.5 \text{ V}$, $0 \text{ mA} \leq I_O \leq 250 \text{ mA}$ | $V_I = V_O + 1 \text{ V}$, 25°C | 180 | 225 | μA | |
| | | -40°C to 125°C | 325 | | | |
| Input current (standby mode) | $\overline{EN} = V_I$, $3 \text{ V} \leq V_I \leq 10 \text{ V}$ | 25°C | 0.5 | | μA | |
| | | -40°C to 125°C | 1 | | | |
| Output current limit threshold | $V_O = 0 \text{ V}$ $V_I = 10 \text{ V}$ | 25°C | 0.6 | 1 | A | |
| | | -40°C to 125°C | 1.5 | | | |
| Pass-element leakage current in standby mode | $EN = V_I$, $3 \text{ V} \leq V_I \leq 10 \text{ V}$ | 25°C | 0.5 | | μA | |
| | | -40°C to 125°C | 1 | | | |
| PG leakage current | $V_{PG} = 10 \text{ V}$, Normal operation | 25°C | 0.5 | | μA | |
| | | -40°C to 125°C | 0.5 | | | |
| Output voltage temperature coefficient | | -40°C to 125°C | 31 | 75 | ppm/°C | |
| Thermal shutdown junction temperature | | | 165 | | °C | |
| \overline{EN} logic high (standby mode) | $3 \text{ V} \leq V_I \leq 6 \text{ V}$ | -40°C to 125°C | 2 | | V | |
| | $6 \text{ V} \leq V_I \leq 10 \text{ V}$ | | 2.7 | | | |
| \overline{EN} logic low (active mode) | $3 \text{ V} \leq V_I \leq 10 \text{ V}$ | 25°C | 0.5 | | V | |
| | | -40°C to 125°C | 0.5 | | | |
| \overline{EN} hysteresis voltage | | 25°C | 50 | | mV | |
| \overline{EN} input current | $0 \text{ V} \leq V_I \leq 10 \text{ V}$ | 25°C | -0.5 | 0.5 | μA | |
| | | -40°C to 125°C | -0.5 | 0.5 | | |
| Minimum V_I for active pass element | | 25°C | 1.9 | 2.5 | V | |
| | | -40°C to 125°C | 2.5 | | | |
| Minimum V_I for valid PG | $I_{PG} = 300 \mu\text{A}$ | 25°C | 1.1 | 1.5 | V | |
| | | -40°C to 125°C | 1.9 | | | |

† CSR(compensation series resistance) refers to the total series resistance, including the equivalent series resistance (ESR) of the capacitor, any series resistance added externally, and PWB trace resistance to C_O .

‡ Pulse-testing techniques are used to maintain virtual junction temperature as close as possible to ambient temperature; thermal effects must be taken into account separately.



**TPS7201Q, TPS7225Q, TPS7230Q
TPS7233Q, TPS7248Q, TPS7250Q, TPS72xxY
MICROPOWER LOW-DROPOUT (LDO) VOLTAGE REGULATORS**

SLVS102G – MARCH 1995 – REVISED JUNE 2000

TPS7201Q electrical characteristics, $I_O = 10$ mA, $V_I = 3.5$ V, $\overline{EN} = 0$ V, $C_O = 4.7$ μ F ($CSR^\dagger = 1$ Ω), FB shorted to OUT at device leads (unless otherwise noted)

| PARAMETER | TEST CONDITIONS [‡] | | T _J | TPS7201Q | | | UNIT |
|---|--|--------------------------------------|----------------|----------------------------------|-------|-----|-----------------------------|
| | | | | MIN | TYP | MAX | |
| Reference voltage (measured at FB with OUT connected to FB) | $V_I = 3.5$ V, | $I_O = 10$ mA | 25°C | 1.188 | | | V |
| | 3 V $\leq V_I \leq 10$ V, See Note 2 | 5 mA $\leq I_O \leq 250$ mA, | -40°C to 125°C | 1.152 | 1.224 | | V |
| Reference voltage temperature coefficient | | | -40°C to 125°C | 31 | 75 | | ppm/°C |
| Pass-element series resistance (see Note 3) | $V_I = 2.4$ V, [§] | 50 μ A $\leq I_O \leq 100$ mA | 25°C | 2.1 | | | Ω |
| | $V_I = 2.4$ V, [§] | 100 mA $\leq I_O \leq 200$ mA | 25°C | 2.9 | | | |
| | $V_I = 2.9$ V, | 50 μ A $\leq I_O \leq 250$ mA | 25°C | 1.6 | 2.7 | | |
| | | | -40°C to 125°C | 4.5 | | | |
| | $V_I = 3.9$ V, | 50 μ A $\leq I_O \leq 250$ mA | 25°C | 1 | | | |
| | $V_I = 5.9$ V, | 50 μ A $\leq I_O \leq 250$ mA | 25°C | 0.8 | | | |
| Input regulation | $V_I = 3$ V to 10 V, See Note 2 | 50 μ A $\leq I_O \leq 250$ mA, | 25°C | 23 | | | mV |
| | | | -40°C to 125°C | 36 | | | |
| Output regulation | $I_O = 5$ mA to 250 mA, See Note 2 | 3 V $\leq V_I \leq 10$ V, | 25°C | 15 | 25 | | mV |
| | | | -40°C to 125°C | 36 | | | |
| | $I_O = 50$ μ A to 250 mA, See Note 2 | 3 V $\leq V_I \leq 10$ V, | 25°C | 17 | 27 | | |
| | | | -40°C to 125°C | 43 | | | |
| Ripple rejection | $f = 120$ Hz | $I_O = 50$ μ A | 25°C | 49 | 60 | | dB |
| | | | -40°C to 125°C | 32 | | | |
| | | $I_O = 250$ mA, See Note 2 | 25°C | 45 | 50 | | |
| | | | -40°C to 125°C | 30 | | | |
| Output noise spectral density | $f = 120$ Hz | | 25°C | 2 | | | μ V/ $\sqrt{\text{Hz}}$ |
| Output noise voltage | 10 Hz $\leq f \leq 100$ kHz, $CSR^\dagger = 1$ Ω | $C_O = 4.7$ μ F | 25°C | 235 | | | μ Vrms |
| | | $C_O = 10$ μ F | 25°C | 190 | | | |
| | | $C_O = 100$ μ F | 25°C | 125 | | | |
| PG trip-threshold voltage [¶] | V_{FB} voltage decreasing from above V_{PG} | | -40°C to 125°C | $0.95 \times V_{FB(\text{nom})}$ | | | V |
| PG hysteresis voltage [¶] | Measured at V_{FB} | | 25°C | 12 | | | mV |
| PG output low voltage [¶] | $I_{PG} = 400$ μ A, | $V_I = 2.13$ V | 25°C | 0.1 | 0.4 | | V |
| | | | -40°C to 125°C | 0.4 | | | |
| FB input current | | | 25°C | -10 | 0.1 | 10 | nA |
| | | | -40°C to 125°C | -20 | 20 | | |

[†] CSR refers to the total series resistance, including the ESR of the capacitor, any series resistance added externally, and PWB trace resistance to C_O .

[‡] Pulse-testing techniques are used to maintain virtual junction temperature as close as possible to ambient temperature; thermal effects must be taken into account separately.

[§] This voltage is not recommended.

[¶] Output voltage programmed to 2.5 V with closed-loop configuration (see application information).

NOTES: 2. When $V_I < 2.9$ V and $I_O > 100$ mA simultaneously, pass element $r_{DS(\text{on})}$ increases (see Figure 10) to a point such that the resulting dropout voltage prevents the regulator from maintaining the specified tolerance range.

3. To calculate dropout voltage, use equation:

$$V_{DO} = I_O \cdot r_{DS(\text{on})}$$

$r_{DS(\text{on})}$ is a function of both output current and input voltage. The parametric table lists $r_{DS(\text{on})}$ for $V_I = 2.4$ V, 2.9 V, 3.9 V, and 5.9 V, which corresponds to dropout conditions for programmed output voltages of 2.5 V, 3 V, 4 V, and 6 V, respectively. For other programmed values, refer to Figures 10 and 11.

TPS7201Q, TPS7225Q, TPS7230Q
 TPS7233Q, TPS7248Q, TPS7250Q, TPS72xxY
MICROPOWER LOW-DROPOUT (LDO) VOLTAGE REGULATORS

SLVS102G – MARCH 1995 – REVISED JUNE 2000

TPS7225Q electrical characteristics, $I_O = 10\text{ mA}$, $V_I = 3.5\text{ V}$, $\overline{EN} = 0\text{ V}$, $C_O = 4.7\text{ }\mu\text{F}$ ($CSR^\dagger = 1\text{ }\Omega$), SENSE shorted to OUT (unless otherwise noted)

| PARAMETER | TEST CONDITIONS‡ | | T _J | TPS7225Q | | | UNIT |
|--------------------------------|--|---|--------------------------------|---------------------------------|------|--------------------------------|------------------|
| | | | | MIN | TYP | MAX | |
| Output voltage | $V_I = 3.5\text{ V}$, | $I_O = 10\text{ mA}$ | 25°C | 2.5 | | | V |
| | $3.5\text{ V} \leq V_I \leq 10\text{ V}$, | $5\text{ mA} \leq I_O \leq 250\text{ mA}$ | -40°C to 125°C | 2.45 | 2.55 | | |
| Dropout voltage | $I_O = 250\text{ mA}$, | $V_I = 2.97\text{ V}$ | 25°C | 560 | 850 | | mV |
| | | | -40°C to 125°C | 1.1 | | | V |
| Pass-element series resistance | $(2.97\text{ V} - V_O)/I_O$, | $V_I = 2.97\text{ V}$, | 25°C | 2.24 | 3.4 | | Ω |
| | | | -40°C to 125°C | 3.84 | | | |
| Input regulation | $V_I = 3.5\text{ V to }10\text{ V}$, | $50\text{ }\mu\text{A} \leq I_O \leq 250\text{ mA}$ | 25°C | 9 | 27 | | mV |
| | | | -40°C to 125°C | 33 | | | |
| Output regulation | $I_O = 5\text{ mA to }250\text{ mA}$, | $3.5\text{ V} \leq V_I \leq 10\text{ V}$ | 25°C | 28 | 36 | | mV |
| | | | -40°C to 125°C | 60 | | | |
| | $I_O = 50\text{ }\mu\text{A to }250\text{ mA}$, | $3.5\text{ V} \leq V_I \leq 10\text{ V}$ | 25°C | 24 | 41 | | |
| | | | -40°C to 125°C | 73 | | | |
| Ripple rejection | $f = 120\text{ Hz}$ | $I_O = 50\text{ }\mu\text{A}$ | 25°C | 47 | 58 | | dB |
| | | | -40°C to 125°C | 45 | | | |
| | | $I_O = 250\text{ mA}$ | 25°C | 40 | 46 | | |
| | | | -40°C to 125°C | 38 | | | |
| Output noise spectral density | $f = 120\text{ Hz}$ | | 25°C | 2 | | $\mu\text{V}/\sqrt{\text{Hz}}$ | |
| Output noise voltage | $10\text{ Hz} \leq f \leq 100\text{ kHz}$, | $CSR^\dagger = 1\text{ }\Omega$ | $C_O = 4.7\text{ }\mu\text{F}$ | 25°C | 248 | | μVrms |
| | | | $C_O = 10\text{ }\mu\text{F}$ | 25°C | 200 | | |
| | | | $C_O = 100\text{ }\mu\text{F}$ | 25°C | 130 | | |
| PG trip-threshold voltage | V_O voltage decreasing from above V_{PG} | | -40°C to 125°C | $0.95 \times V_{O(\text{nom})}$ | | V | |
| PG hysteresis voltage | | | 25°C | 50 | | mV | |
| PG output low voltage | $I_{PG} = 1.2\text{ mA}$, | $V_I = 2.13\text{ V}$ | 25°C | 0.3 | 0.44 | | V |
| | | | -40°C to 125°C | 0.5 | | | |

† CSR refers to the total series resistance, including the ESR of the capacitor, any series resistance added externally, and PWB trace resistance to C_O .

‡ Pulse-testing techniques are used to maintain virtual junction temperature as close as possible to ambient temperature; thermal effects must be taken into account separately.



TPS7201Q, TPS7225Q, TPS7230Q
 TPS7233Q, TPS7248Q, TPS7250Q, TPS72xxY
MICROPOWER LOW-DROPOUT (LDO) VOLTAGE REGULATORS

SLVS102G – MARCH 1995 – REVISED JUNE 2000

TPS7230Q electrical characteristics, $I_O = 10\text{ mA}$, $V_I = 4\text{ V}$, $\overline{EN} = 0\text{ V}$, $C_O = 4.7\text{ }\mu\text{F}$ ($CSR^\dagger = 1\text{ }\Omega$), SENSE shorted to OUT (unless otherwise noted)

| PARAMETER | TEST CONDITIONS‡ | | T _J | TPS7230Q | | | UNIT |
|--------------------------------|--|---|-----------------------|---------------------------------|------|--------------------------------|----------|
| | | | | MIN | TYP | MAX | |
| Output voltage | $V_I = 4\text{ V}$, | $I_O = 10\text{ mA}$ | 25°C | 3 | | | V |
| | $4\text{ V} \leq V_I \leq 10\text{ V}$, | $5\text{ mA} \leq I_O \leq 250\text{ mA}$ | -40°C to 125°C | 2.94 | 3.06 | | |
| Dropout voltage | $I_O = 100\text{ mA}$, | $V_I = 2.97\text{ V}$ | 25°C | 145 | 185 | | mV |
| | | | -40°C to 125°C | 270 | | | |
| | $I_O = 250\text{ mA}$, | $V_I = 2.97\text{ V}$ | 25°C | 390 | 502 | | |
| | | | -40°C to 125°C | 900 | | | |
| Pass-element series resistance | $(2.97\text{ V} - V_O)/I_O$, | $V_I = 2.97\text{ V}$, | 25°C | 1.56 | 2.01 | | Ω |
| | | | $I_O = 250\text{ mA}$ | 3.6 | | | |
| Input regulation | $V_I = 4\text{ V}$ to 10 V, | $50\text{ }\mu\text{A} \leq I_O \leq 250\text{ mA}$ | 25°C | 9 | 27 | | mV |
| | | | -40°C to 125°C | 33 | | | |
| Output regulation | $I_O = 5\text{ mA}$ to 250 mA, | $4\text{ V} \leq V_I \leq 10\text{ V}$ | 25°C | 34 | 45 | | mV |
| | | | -40°C to 125°C | 74 | | | |
| | $I_O = 50\text{ }\mu\text{A}$ to 250 mA, | $4\text{ V} \leq V_I \leq 10\text{ V}$ | 25°C | 42 | 60 | | |
| | | | -40°C to 125°C | 98 | | | |
| Ripple rejection | $f = 120\text{ Hz}$ | $I_O = 50\text{ }\mu\text{A}$ | 25°C | 45 | 56 | | dB |
| | | | -40°C to 125°C | 44 | | | |
| | | $I_O = 250\text{ mA}$ | 25°C | 40 | 45 | | |
| | | | -40°C to 125°C | 38 | | | |
| Output noise spectral density | $f = 120\text{ Hz}$ | | 25°C | 2 | | $\mu\text{V}/\sqrt{\text{Hz}}$ | |
| Output noise voltage | $10\text{ Hz} \leq f \leq 100\text{ kHz}$, | $CSR^\dagger = 1\text{ }\Omega$ | 25°C | 256 | | μV_{rms} | |
| | | | 25°C | 206 | | | |
| | | | 25°C | 132 | | | |
| PG trip-threshold voltage | V_O voltage decreasing from above V_{PG} | | -40°C to 125°C | $0.95 \times V_{O(\text{nom})}$ | | V | |
| PG hysteresis voltage | | | 25°C | 50 | | mV | |
| PG output low voltage | $I_{PG} = 1.2\text{ mA}$, | $V_I = 2.55\text{ V}$ | 25°C | 0.25 | 0.44 | | V |
| | | | -40°C to 125°C | 0.44 | | | |

† CSR refers to the total series resistance, including the ESR of the capacitor, any series resistance added externally, and PWB trace resistance to C_O .

‡ Pulse-testing techniques are used to maintain virtual junction temperature as close as possible to ambient temperature; thermal effects must be taken into account separately.

TPS7201Q, TPS7225Q, TPS7230Q
 TPS7233Q, TPS7248Q, TPS7250Q, TPS72xxY
 MICROPPOWER LOW-DROPOUT (LDO) VOLTAGE REGULATORS

SLVS102G – MARCH 1995 – REVISED JUNE 2000

TPS7233Q electrical characteristics, $I_O = 10\text{ mA}$, $V_I = 4.3\text{ V}$, $\overline{EN} = 0\text{ V}$, $C_O = 4.7\text{ }\mu\text{F}$ ($CSR^\dagger = 1\text{ }\Omega$), SENSE shorted to OUT (unless otherwise noted)

| PARAMETER | TEST CONDITIONS‡ | | T _J | TPS7233Q | | | UNIT |
|--------------------------------|---|---|--------------------------------|---------------------------------|------|--------------------------------|----------------------------|
| | | | | MIN | TYP | MAX | |
| Output voltage | $V_I = 4.3\text{ V}$, | $I_O = 10\text{ mA}$ | 25°C | 3.3 | | | V |
| | $4.3\text{ V} \leq V_I \leq 10\text{ V}$, | $5\text{ mA} \leq I_O \leq 250\text{ mA}$ | -40°C to 125°C | 3.23 | 3.37 | | |
| Dropout voltage | $I_O = 10\text{ mA}$, | $V_I = 3.23\text{ V}$ | 25°C | 14 | | 20 | mV |
| | | | -40°C to 125°C | 30 | | | |
| | $I_O = 100\text{ mA}$, | $V_I = 3.23\text{ V}$ | 25°C | 140 | | 180 | |
| | | | -40°C to 125°C | 232 | | | |
| | $I_O = 250\text{ mA}$, | $V_I = 3.23\text{ V}$ | 25°C | 360 | | 460 | |
| | | | -40°C to 125°C | 610 | | | |
| Pass-element series resistance | $(3.23\text{ V} - V_O)/I_O$, | $V_I = 3.23\text{ V}$, | 25°C | 1.5 | | 1.84 | Ω |
| | | | $I_O = 250\text{ mA}$ | -40°C to 125°C | 2.5 | | |
| Input regulation | $V_I = 4.3\text{ V to }10\text{ V}$, | $50\text{ }\mu\text{A} \leq I_O \leq 250\text{ mA}$ | 25°C | 8 | | 25 | mV |
| | | | -40°C to 125°C | 33 | | | |
| Output regulation | $I_O = 5\text{ mA to }250\text{ mA}$, | $4.3\text{ V} \leq V_I \leq 10\text{ V}$ | 25°C | 32 | | 42 | mV |
| | | | -40°C to 125°C | 71 | | | |
| | $I_O = 50\text{ }\mu\text{A to }250\text{ mA}$, | $4.3\text{ V} \leq V_I \leq 10\text{ V}$ | 25°C | 41 | | 55 | |
| | | | -40°C to 125°C | 98 | | | |
| Ripple rejection | $f = 120\text{ Hz}$ | $I_O = 50\text{ }\mu\text{A}$ | 25°C | 40 | | 52 | dB |
| | | | -40°C to 125°C | 38 | | | |
| | | $I_O = 250\text{ mA}$ | 25°C | 35 | | 44 | |
| | | | -40°C to 125°C | 33 | | | |
| Output noise spectral density | $f = 120\text{ Hz}$ | | 25°C | 2 | | $\mu\text{V}/\sqrt{\text{Hz}}$ | |
| Output noise voltage | $10\text{ Hz} \leq f \leq 100\text{ kHz}$, | $CSR^\dagger = 1\text{ }\Omega$ | $C_O = 4.7\text{ }\mu\text{F}$ | 25°C | | 265 | μV_{rms} |
| | | | $C_O = 10\text{ }\mu\text{F}$ | 25°C | | 212 | |
| | | | $C_O = 100\text{ }\mu\text{F}$ | 25°C | | 135 | |
| PG trip-threshold voltage | V_O voltage decreasing from above V_{PG} | | -40°C to 125°C | $0.95 \times V_{O(\text{nom})}$ | | V | |
| PG hysteresis voltage | | | 25°C | 32 | | mV | |
| PG output low voltage | $I_{\text{PG}} = 1.2\text{ mA}$, | $V_I = 2.8\text{ V}$ | 25°C | 0.22 | | 0.4 | V |
| | | | -40°C to 125°C | 0.4 | | | |

† CSR refers to the total series resistance, including the ESR of the capacitor, any series resistance added externally, and PWB trace resistance to C_O .

‡ Pulse-testing techniques are used to maintain virtual junction temperature as close as possible to ambient temperature; thermal effects must be taken into account separately.



TPS7201Q, TPS7225Q, TPS7230Q
 TPS7233Q, TPS7248Q, TPS7250Q, TPS72xxY
MICROPOWER LOW-DROPOUT (LDO) VOLTAGE REGULATORS

SLVS102G – MARCH 1995 – REVISED JUNE 2000

TPS7248Q electrical characteristics, $I_O = 10\text{ mA}$, $V_I = 5.85\text{ V}$, $\overline{EN} = 0\text{ V}$, $C_O = 4.7\text{ }\mu\text{F}$ ($\text{CSR}^\dagger = 1\text{ }\Omega$), SENSE shorted to OUT (unless otherwise noted)

| PARAMETER | TEST CONDITIONS [‡] | | T _J | TPS7248Q | | | UNIT |
|--------------------------------|---|---|-----------------------|---------------------------------|------|--------------------------------|----------|
| | | | | MIN | TYP | MAX | |
| Output voltage | $V_I = 5.85\text{ V}$, | $I_O = 10\text{ mA}$ | 25°C | 4.85 | | | V |
| | $5.85\text{ V} \leq V_I \leq 10\text{ V}$, | $5\text{ mA} \leq I_O \leq 250\text{ mA}$ | -40°C to 125°C | 4.75 | 4.95 | | |
| Dropout voltage | $I_O = 10\text{ mA}$, | $V_I = 4.75\text{ V}$ | 25°C | 10 | | 19 | mV |
| | | | -40°C to 125°C | 30 | | | |
| | $I_O = 100\text{ mA}$, | $V_I = 4.75\text{ V}$ | 25°C | 90 | | 100 | |
| | | | -40°C to 125°C | 150 | | | |
| | $I_O = 250\text{ mA}$, | $V_I = 4.75\text{ V}$ | 25°C | 216 | | 250 | |
| | | | -40°C to 125°C | 285 | | | |
| Pass-element series resistance | $(4.75\text{ V} - V_O)/I_O$, | $V_I = 4.75\text{ V}$, | 25°C | 0.8 | | 1 | Ω |
| | | | $I_O = 250\text{ mA}$ | 1.4 | | | |
| Input regulation | $V_I = 5.85\text{ V}$ to 10 V, | $50\text{ }\mu\text{A} \leq I_O \leq 250\text{ mA}$ | 25°C | 34 | | | mV |
| | | | -40°C to 125°C | 50 | | | |
| Output regulation | $I_O = 5\text{ mA}$ to 250 mA, | $5.85\text{ V} \leq V_I \leq 10\text{ V}$ | 25°C | 43 | | 55 | mV |
| | | | -40°C to 125°C | 95 | | | |
| | $I_O = 50\text{ }\mu\text{A}$ to 250 mA, | $5.85\text{ V} \leq V_I \leq 10\text{ V}$ | 25°C | 55 | | 75 | |
| | | | -40°C to 125°C | 135 | | | |
| Ripple rejection | $f = 120\text{ Hz}$ | $I_O = 50\text{ }\mu\text{A}$ | 25°C | 42 | | 53 | dB |
| | | | -40°C to 125°C | 36 | | | |
| | | $I_O = 250\text{ mA}$ | 25°C | 36 | | 46 | |
| | | | -40°C to 125°C | 34 | | | |
| Output noise spectral density | $f = 120\text{ Hz}$ | | 25°C | 2 | | $\mu\text{V}/\sqrt{\text{Hz}}$ | |
| Output noise voltage | $10\text{ Hz} \leq f \leq 100\text{ kHz}$, | $\text{CSR}^\dagger = 1\text{ }\Omega$ | 25°C | 370 | | μV_{rms} | |
| | | | 25°C | 290 | | | |
| | | | 25°C | 168 | | | |
| PG trip-threshold voltage | V_O voltage decreasing from above V_{PG} | | -40°C to 125°C | $0.95 \times V_{O(\text{nom})}$ | | V | |
| PG hysteresis voltage | | | 25°C | 50 | | mV | |
| PG output low voltage | $I_{\text{PG}} = 1.2\text{ mA}$, | $V_I = 4.12\text{ V}$ | 25°C | 0.2 | | 0.4 | V |
| | | | -40°C to 125°C | 0.4 | | | |

[†] CSR refers to the total series resistance, including the ESR of the capacitor, any series resistance added externally, and PWB trace resistance to C_O .

[‡] Pulse-testing techniques are used to maintain virtual junction temperature as close as possible to ambient temperature; thermal effects must be taken into account separately.

TPS7201Q, TPS7225Q, TPS7230Q
 TPS7233Q, TPS7248Q, TPS7250Q, TPS72xxY
MICROPOWER LOW-DROPOUT (LDO) VOLTAGE REGULATORS

SLVS102G – MARCH 1995 – REVISED JUNE 2000

TPS7250Q electrical characteristics, $I_O = 10\text{ mA}$, $V_I = 6\text{ V}$, $\overline{EN} = 0\text{ V}$, $C_O = 4.7\text{ }\mu\text{F}$ ($CSR^\dagger = 1\text{ }\Omega$), SENSE shorted to OUT (unless otherwise noted)

| PARAMETER | TEST CONDITIONS‡ | T _J | TPS7250Q | | | UNIT |
|--------------------------------|---|--------------------------------|---------------------------------|-------|--------------------------------|----------------------------|
| | | | MIN | TYP | MAX | |
| Output voltage | $V_I = 6\text{ V}$, $I_O = 10\text{ mA}$ | 25°C | 5 | | | V |
| | $6\text{ V} \leq V_I \leq 10\text{ V}$, $5\text{ mA} \leq I_O \leq 250\text{ mA}$ | -40°C to 125°C | 4.9 | 5.1 | | |
| Dropout voltage | $I_O = 10\text{ mA}$, $V_I = 4.88\text{ V}$ | 25°C | 8 | | 12 | mV |
| | | -40°C to 125°C | | | | |
| | $I_O = 100\text{ mA}$, $V_I = 4.88\text{ V}$ | 25°C | 76 | | 85 | |
| | | -40°C to 125°C | | | 136 | |
| | $I_O = 250\text{ mA}$, $V_I = 4.88\text{ V}$ | 25°C | 190 | | 206 | |
| | | -40°C to 125°C | | | 312 | |
| Pass-element series resistance | $(4.88\text{ V} - V_O)/I_O$, $I_O = 250\text{ mA}$, $V_I = 4.88\text{ V}$ | 25°C | 0.76 | 0.825 | | Ω |
| | | -40°C to 125°C | 1.25 | | | |
| Input regulation | $V_I = 6\text{ V to }10\text{ V}$, $50\text{ }\mu\text{A} \leq I_O \leq 250\text{ mA}$ | 25°C | 28 | | | mV |
| | | -40°C to 125°C | 35 | | | |
| Output regulation | $I_O = 5\text{ mA to }250\text{ mA}$, $6\text{ V} \leq V_I \leq 10\text{ V}$ | 25°C | 46 | | 61 | mV |
| | | -40°C to 125°C | 100 | | | |
| | $I_O = 50\text{ }\mu\text{A to }250\text{ mA}$, $6\text{ V} \leq V_I \leq 10\text{ V}$ | 25°C | 59 | | 79 | |
| | | -40°C to 125°C | 150 | | | |
| Ripple rejection | $f = 120\text{ Hz}$ | $I_O = 50\text{ }\mu\text{A}$ | 25°C | 41 | 52 | dB |
| | | | -40°C to 125°C | 37 | | |
| | | $I_O = 250\text{ mA}$ | 25°C | 36 | 46 | |
| | | | -40°C to 125°C | 32 | | |
| Output noise spectral density | $f = 120\text{ Hz}$ | 25°C | 2 | | $\mu\text{V}/\sqrt{\text{Hz}}$ | |
| Output noise voltage | $10\text{ Hz} \leq f \leq 100\text{ kHz}$, $CSR^\dagger = 1\text{ }\Omega$ | $C_O = 4.7\text{ }\mu\text{F}$ | 25°C | 390 | | μV_{rms} |
| | | $C_O = 10\text{ }\mu\text{F}$ | 25°C | 300 | | |
| | | $C_O = 100\text{ }\mu\text{F}$ | 25°C | 175 | | |
| PG trip-threshold voltage | V_O voltage decreasing from above V_{PG} | -40°C to 125°C | $0.95 \times V_{O(\text{nom})}$ | | V | |
| PG hysteresis voltage | | 25°C | 50 | | mV | |
| PG output low voltage | $I_{\text{PG}} = 1.2\text{ mA}$, $V_I = 4.25\text{ V}$ | 25°C | 0.19 | 0.4 | | V |
| | | -40°C to 125°C | 0.4 | | | |

† CSR refers to the total series resistance, including the ESR of the capacitor, any series resistance added externally, and PWB trace resistance to C_O .

‡ Pulse-testing techniques are used to maintain virtual junction temperature as close as possible to ambient temperature; thermal effects must be taken into account separately.



TPS7201Q, TPS7225Q, TPS7230Q
 TPS7233Q, TPS7248Q, TPS7250Q, TPS72xxY
MICROPOWER LOW-DROPOUT (LDO) VOLTAGE REGULATORS

SLVS102G – MARCH 1995 – REVISED JUNE 2000

electrical characteristics, $I_O = 10\text{ mA}$, $\overline{EN} = 0\text{ V}$, $C_O = 4.7\text{ }\mu\text{F}$ ($CSR^\dagger = 1\text{ }\Omega$), $T_J = 25^\circ\text{C}$, SENSE/FB shorted to OUT (unless otherwise noted)

| PARAMETER | TEST CONDITIONS‡ | TPS72xxY | | | UNIT |
|---------------------------------------|---|----------|-----|-----|------------------|
| | | MIN | TYP | MAX | |
| Ground current (active mode) | $\overline{EN} \leq 0.5\text{ V}$, $V_I = V_O + 1\text{ V}$, $0\text{ mA} \leq I_O \leq 250\text{ mA}$ | | 180 | | μA |
| Output current limit threshold | $V_O = 0\text{ V}$, $V_I = 10\text{ V}$ | | 0.6 | | A |
| Thermal shutdown junction temperature | | | 165 | | $^\circ\text{C}$ |
| \overline{EN} hysteresis voltage | | | 50 | | mV |
| Minimum V_I for active pass element | | | 1.9 | | V |
| Minimum V_I for valid PG | $I_{PG} = 300\text{ }\mu\text{A}$ | | 1.1 | | V |

electrical characteristics, $I_O = 10\text{ mA}$, $\overline{EN} = 0\text{ V}$, $C_O = 4.7\text{ }\mu\text{F}$ ($CSR^\dagger = 1\text{ }\Omega$), $T_J = 25^\circ\text{C}$, FB shorted to OUT at device leads (unless otherwise noted)

| PARAMETER | TEST CONDITIONS‡ | TPS7201Y | | | UNIT |
|---|---|---------------------------------------|-------|-----|--------------------------------|
| | | MIN | TYP | MAX | |
| Reference voltage (measured at FB with OUT connected to FB) | $V_I = 3.5\text{ V}$, $I_O = 10\text{ mA}$ | | 1.188 | | V |
| Pass-element series resistance (see Note 3) | $V_I = 2.4\text{ V}$, § $50\text{ }\mu\text{A} \leq I_O \leq 100\text{ mA}$ | | 2.1 | | Ω |
| | $V_I = 2.4\text{ V}$, § $100\text{ mA} \leq I_O \leq 200\text{ mA}$ | | 2.9 | | |
| | $V_I = 2.9\text{ V}$, $50\text{ }\mu\text{A} \leq I_O \leq 250\text{ mA}$ | | 1.6 | | |
| | $V_I = 3.9\text{ V}$, $50\text{ }\mu\text{A} \leq I_O \leq 250\text{ mA}$ | | 1 | | |
| | $V_I = 5.9\text{ V}$, $50\text{ }\mu\text{A} \leq I_O \leq 250\text{ mA}$ | | 0.8 | | |
| Output regulation | $3\text{ V} \leq V_I \leq 10\text{ V}$, See Note 2, $I_O = 5\text{ mA to } 250\text{ mA}$, | | 15 | | mV |
| | $3\text{ V} \leq V_I \leq 10\text{ V}$, See Note 2, $I_O = 50\text{ }\mu\text{A to } 250\text{ mA}$, | | 17 | | |
| Ripple rejection | $V_I = 3.5\text{ V}$, $f = 120\text{ Hz}$ | $I_O = 50\text{ }\mu\text{A}$ | 60 | | dB |
| | | $I_O = 250\text{ mA}$, See Note 2 | 50 | | |
| Output noise spectral density | $V_I = 3.5\text{ V}$, $f = 120\text{ Hz}$ | | 2 | | $\mu\text{V}/\sqrt{\text{Hz}}$ |
| Output noise voltage | $V_I = 3.5\text{ V}$, $10\text{ Hz} \leq f \leq 100\text{ kHz}$, $CSR^\dagger = 1\text{ }\Omega$ | $C_O = 4.7\text{ }\mu\text{F}$ | 235 | | μV_{rms} |
| | | $C_O = 10\text{ }\mu\text{F}$ | 190 | | |
| | | $C_O = 100\text{ }\mu\text{F}$ | 125 | | |
| PG hysteresis voltage¶ | $V_I = 3.5\text{ V}$, Measured at V_{FB} | | 12 | | mV |
| PG output low voltage¶ | $V_I = 2.13\text{ V}$, $I_{PG} = 400\text{ }\mu\text{A}$ | | 0.1 | | V |
| FB input current | $V_I = 3.5\text{ V}$ | | 0.1 | | nA |

† CSR refers to the total series resistance, including the ESR of the capacitor, any series resistance added externally, and PWB trace resistance to C_O .

‡ Pulse-testing techniques are used to maintain virtual junction temperature as close as possible to ambient temperature; thermal effects must be taken into account separately.

§ This voltage is not recommended.

¶ Output voltage programmed to 2.5 V with closed-loop configuration (see application information).

NOTES: 2 When $V_I < 2.9\text{ V}$ and $I_O > 100\text{ mA}$ simultaneously, pass element $r_{DS(on)}$ increases (see Figure 10) to a point such that the resulting dropout voltage prevents the regulator from maintaining the specified tolerance range.

3 To calculate dropout voltage, use equation:

$$V_{DO} = I_O \cdot r_{DS(on)}$$

$r_{DS(on)}$ is a function of both output current and input voltage. The parametric table lists $r_{DS(on)}$ for $V_I = 2.4\text{ V}$, 2.9 V , 3.9 V , and 5.9 V , which corresponds to dropout conditions for programmed output voltages of 2.5 V, 3 V, 4 V, and 6 V, respectively. For other programmed values, refer to Figures 10 and 11.



TPS7201Q, TPS7225Q, TPS7230Q
 TPS7233Q, TPS7248Q, TPS7250Q, TPS72xxY
MICROPOWER LOW-DROPOUT (LDO) VOLTAGE REGULATORS

SLVS102G – MARCH 1995 – REVISED JUNE 2000

electrical characteristics, $I_O = 10 \text{ mA}$, $\overline{EN} = 0 \text{ V}$, $C_O = 4.7 \mu\text{F}$ ($\text{CSR}^\dagger = 1 \Omega$), $T_J = 25^\circ\text{C}$, FB shorted to OUT at device leads (unless otherwise noted)

| PARAMETER | TEST CONDITIONS‡ | TPS7225Y | | | UNIT |
|--------------------------------|---|-------------------------|-----|-----|--------------------------------|
| | | MIN | TYP | MAX | |
| Output voltage | $V_I = 3.5 \text{ V}$, $I_O = 10 \text{ mA}$ | 2.5 | | | V |
| Dropout voltage | $V_I = 2.97 \text{ V}$, $I_O = 250 \text{ mA}$ | 560 | | | mV |
| Pass-element series resistance | $(2.97 \text{ V} - V_O)/I_O$, $I_O = 250 \text{ mA}$, $V_I = 2.97 \text{ V}$ | 2.24 | | | Ω |
| Input regulation | $V_I = 3.5 \text{ V to } 10 \text{ V}$, $50 \mu\text{A} \leq I_O \leq 250 \text{ mA}$ | 9 | | | mV |
| Output regulation | $3.5 \text{ V} \leq V_I \leq 10 \text{ V}$, $I_O = 5 \text{ mA to } 250 \text{ mA}$ | 28 | | | mV |
| | $3.5 \text{ V} \leq V_I \leq 10 \text{ V}$, $I_O = 50 \mu\text{A to } 250 \text{ mA}$ | 24 | | | |
| Ripple rejection | $V_I = 3.5 \text{ V}$, $f = 120 \text{ Hz}$ | $I_O = 50 \mu\text{A}$ | 58 | | dB |
| | | $I_O = 250 \text{ mA}$ | 46 | | |
| Output noise spectral density | $V_I = 3.5 \text{ V}$, $f = 120 \text{ Hz}$ | 2 | | | $\mu\text{V}/\sqrt{\text{Hz}}$ |
| Output noise voltage | $V_I = 3.5 \text{ V}$, $10 \text{ Hz} \leq f \leq 100 \text{ kHz}$, $\text{CSR}^\dagger = 1 \Omega$ | $C_O = 4.7 \mu\text{F}$ | 248 | | μV_{rms} |
| | | $C_O = 10 \mu\text{F}$ | 200 | | |
| | | $C_O = 100 \mu\text{F}$ | 130 | | |
| PG hysteresis voltage | $V_I = 3.5 \text{ V}$ | 50 | | | mV |
| PG output low voltage | $V_I = 2.13 \text{ V}$, $I_{\text{PG}} = 1.2 \text{ mA}$ | 0.3 | | | V |

† CSR refers to the total series resistance, including the ESR of the capacitor, any series resistance added externally, and PWB trace resistance to C_O .

‡ Pulse-testing techniques are used to maintain virtual junction temperature as close as possible to ambient temperature; thermal effects must be taken into account separately.



TPS7201Q, TPS7225Q, TPS7230Q
 TPS7233Q, TPS7248Q, TPS7250Q, TPS72xxY
MICROPOWER LOW-DROPOUT (LDO) VOLTAGE REGULATORS

SLVS102G – MARCH 1995 – REVISED JUNE 2000

electrical characteristics, $I_O = 10\text{ mA}$, $\overline{EN} = 0\text{ V}$, $C_O = 4.7\text{ }\mu\text{F}$ ($\text{CSR}^\dagger = 1\text{ }\Omega$), $T_J = 25^\circ\text{C}$, SENSE shorted to OUT (unless otherwise noted)

| PARAMETER | TEST CONDITIONS‡ | | TPS7230Y | | | UNIT |
|--------------------------------|---|---|----------|------|-----|--------------------------------|
| | | | MIN | TYP | MAX | |
| Output voltage | $V_I = 4\text{ V}$, | $I_O = 10\text{ mA}$ | | 3 | | V |
| Dropout voltage | $V_I = 2.97\text{ V}$, | $I_O = 100\text{ mA}$ | | 145 | | mV |
| | $V_I = 2.97\text{ V}$, | $I_O = 250\text{ mA}$ | | 390 | | |
| Pass-element series resistance | $(2.97\text{ V} - V_O)/I_O$, | $V_I = 2.97\text{ V}$, | | 1.56 | | Ω |
| Input regulation | $V_I = 4\text{ V to }10\text{ V}$, | $50\text{ }\mu\text{A} \leq I_O \leq 250\text{ mA}$ | | 9 | | mV |
| Output regulation | $4\text{ V} \leq V_I \leq 10\text{ V}$ | $I_O = 5\text{ mA to }250\text{ mA}$ | | 34 | | mV |
| | $4\text{ V} \leq V_I \leq 10\text{ V}$ | $I_O = 50\text{ }\mu\text{A to }250\text{ mA}$ | | 41 | | |
| Ripple rejection | $V_I = 4\text{ V}$, $f = 120\text{ Hz}$ | $I_O = 50\text{ }\mu\text{A}$ | | 56 | | dB |
| | | $I_O = 250\text{ mA}$ | | 45 | | |
| Output noise spectral density | $V_I = 4\text{ V}$, | $f = 120\text{ Hz}$ | | 2 | | $\mu\text{V}/\sqrt{\text{Hz}}$ |
| Output noise voltage | $V_I = 4\text{ V}$, $10\text{ Hz} \leq f \leq 100\text{ kHz}$, $\text{CSR}^\dagger = 1\text{ }\Omega$ | $C_O = 4.7\text{ }\mu\text{F}$ | | 256 | | μV_{rms} |
| | | $C_O = 10\text{ }\mu\text{F}$ | | 206 | | |
| | | $C_O = 100\text{ }\mu\text{F}$ | | 132 | | |
| PG hysteresis voltage | $V_I = 4\text{ V}$ | | | 50 | | mV |
| PG output low voltage | $V_I = 2.55\text{ V}$ | $I_{\text{PG}} = 1.2\text{ mA}$ | | 0.25 | | V |

† CSR refers to the total series resistance, including the ESR of the capacitor, any series resistance added externally, and PWB trace resistance to C_O .

‡ Pulse-testing techniques are used to maintain virtual junction temperature as close as possible to ambient temperature; thermal effects must be taken into account separately.

| PARAMETER | TEST CONDITIONS‡ | | TPS7233Y | | | UNIT |
|--------------------------------|---|---|----------|------|-----|--------------------------------|
| | | | MIN | TYP | MAX | |
| Output voltage | $V_I = 4.3\text{ V}$, | $I_O = 10\text{ mA}$ | | 3.3 | | V |
| Dropout voltage | $V_I = 3.23\text{ V}$, | $I_O = 10\text{ mA}$ | | 14 | | mV |
| | $V_I = 3.23\text{ V}$, | $I_O = 100\text{ mA}$ | | 140 | | |
| | $V_I = 3.23\text{ V}$, | $I_O = 250\text{ mA}$ | | 360 | | |
| Pass-element series resistance | $(3.23\text{ V} - V_O)/I_O$, | $V_I = 3.23\text{ V}$, | | 1.5 | | Ω |
| Input regulation | $V_I = 4.3\text{ V to }10\text{ V}$, | $50\text{ }\mu\text{A} \leq I_O \leq 250\text{ mA}$ | | 8 | | mV |
| Output regulation | $4.3\text{ V} \leq V_I \leq 10\text{ V}$, | $I_O = 5\text{ mA to }250\text{ mA}$ | | 32 | | mV |
| | $4.3\text{ V} \leq V_I \leq 10\text{ V}$, | $I_O = 50\text{ }\mu\text{A to }250\text{ mA}$ | | 41 | | |
| Ripple rejection | $V_I = 4.3\text{ V}$, $f = 120\text{ Hz}$ | $I_O = 50\text{ }\mu\text{A}$ | | 52 | | dB |
| | | $I_O = 250\text{ mA}$ | | 44 | | |
| Output noise spectral density | $V_I = 4.3\text{ V}$, | $f = 120\text{ Hz}$ | | 2 | | $\mu\text{V}/\sqrt{\text{Hz}}$ |
| Output noise voltage | $V_I = 4.3\text{ V}$, $10\text{ Hz} \leq f \leq 100\text{ kHz}$, $\text{CSR}^\dagger = 1\text{ }\Omega$ | $C_O = 4.7\text{ }\mu\text{F}$ | | 265 | | μV_{rms} |
| | | $C_O = 10\text{ }\mu\text{F}$ | | 212 | | |
| | | $C_O = 100\text{ }\mu\text{F}$ | | 135 | | |
| PG hysteresis voltage | $V_I = 4.3\text{ V}$ | | | 32 | | mV |
| PG output low voltage | $V_I = 2.8\text{ V}$, | $I_{\text{PG}} = 1.2\text{ mA}$ | | 0.22 | | V |

† CSR refers to the total series resistance, including the ESR of the capacitor, any series resistance added externally, and PWB trace resistance to C_O .

‡ Pulse-testing techniques are used to maintain virtual junction temperature as close as possible to ambient temperature; thermal effects must be taken into account separately.



TPS7201Q, TPS7225Q, TPS7230Q
 TPS7233Q, TPS7248Q, TPS7250Q, TPS72xxY
 MICROPOWER LOW-DROPOUT (LDO) VOLTAGE REGULATORS

SLVS102G – MARCH 1995 – REVISED JUNE 2000

electrical characteristics, $I_O = 10\text{ mA}$, $\overline{EN} = 0\text{ V}$, $C_O = 4.7\text{ }\mu\text{F}$ ($\text{CSR}^\dagger = 1\text{ }\Omega$), $T_J = 25^\circ\text{C}$, SENSE shorted to OUT (unless otherwise noted) (continued)

| PARAMETER | TEST CONDITIONS‡ | TPS7248Y | | | UNIT |
|--------------------------------|--|--------------------------------|-----|-----|--------------------------------|
| | | MIN | TYP | MAX | |
| Output voltage | $V_I = 5.85\text{ V}$, $I_O = 10\text{ mA}$ | 4.85 | | | V |
| Dropout voltage | $V_I = 4.75\text{ V}$, $I_O = 10\text{ mA}$ | 10 | | | mV |
| | $V_I = 4.75\text{ V}$, $I_O = 100\text{ mA}$ | 90 | | | |
| | $V_I = 4.75\text{ V}$, $I_O = 250\text{ mA}$ | 216 | | | |
| Pass-element series resistance | $(4.75\text{ V} - V_O)/I_O$, $I_O = 250\text{ mA}$, $V_I = 4.75\text{ V}$ | 0.8 | | | Ω |
| Output regulation | $5.85\text{ V} \leq V_I \leq 10\text{ V}$, $I_O = 5\text{ mA to }250\text{ mA}$ | 43 | | | mV |
| | $5.85\text{ V} \leq V_I \leq 10\text{ V}$, $I_O = 50\text{ }\mu\text{A to }250\text{ mA}$ | 55 | | | |
| Ripple rejection | $V_I = 5.85\text{ V}$, $f = 120\text{ Hz}$ | $I_O = 50\text{ }\mu\text{A}$ | 53 | | dB |
| | | $I_O = 250\text{ mA}$ | 46 | | |
| Output noise spectral density | $V_I = 5.85\text{ V}$, $f = 120\text{ Hz}$ | 2 | | | $\mu\text{V}/\sqrt{\text{Hz}}$ |
| Output noise voltage | $V_I = 5.85\text{ V}$, $10\text{ Hz} \leq f \leq 100\text{ kHz}$, $\text{CSR}^\dagger = 1\text{ }\Omega$ | $C_O = 4.7\text{ }\mu\text{F}$ | 370 | | μV_{rms} |
| | | $C_O = 10\text{ }\mu\text{F}$ | 290 | | |
| | | $C_O = 100\text{ }\mu\text{F}$ | 168 | | |
| PG hysteresis voltage | $V_I = 5.85\text{ V}$ | 50 | | | mV |
| PG output low voltage | $V_I = 4.12\text{ V}$, $I_{\text{PG}} = 1.2\text{ mA}$ | 0.2 | | | V |

† CSR refers to the total series resistance, including the ESR of the capacitor, any series resistance added externally, and PWB trace resistance to C_O .

‡ Pulse-testing techniques are used to maintain virtual junction temperature as close as possible to ambient temperature; thermal effects must be taken into account separately.

| PARAMETER | TEST CONDITIONS‡ | TPS7250Y | | | UNIT |
|--------------------------------|---|--------------------------------|-----|-----|--------------------------------|
| | | MIN | TYP | MAX | |
| Output voltage | $V_I = 6\text{ V}$, $I_O = 10\text{ mA}$ | 5 | | | V |
| Dropout voltage | $V_I = 4.88\text{ V}$, $I_O = 10\text{ mA}$ | 8 | | | mV |
| | $V_I = 4.88\text{ V}$, $I_O = 100\text{ mA}$ | 76 | | | |
| | $V_I = 4.88\text{ V}$, $I_O = 250\text{ mA}$ | 190 | | | |
| Pass-element series resistance | $(4.88\text{ V} - V_O)/I_O$, $I_O = 250\text{ mA}$, $V_I = 4.88\text{ V}$ | 0.76 | | | Ω |
| Input regulation | $V_I = 6\text{ V to }10\text{ V}$, $50\text{ }\mu\text{A} \leq I_O \leq 250\text{ mA}$ | | | | mV |
| Output regulation | $6\text{ V} \leq V_I \leq 10\text{ V}$, $I_O = 5\text{ mA to }250\text{ mA}$ | 46 | | | mV |
| | $6\text{ V} \leq V_I \leq 10\text{ V}$, $I_O = 50\text{ }\mu\text{A to }250\text{ mA}$ | 59 | | | |
| Ripple rejection | $V_I = 6\text{ V}$, $f = 120\text{ Hz}$ | $I_O = 50\text{ }\mu\text{A}$ | 52 | | dB |
| | | $I_O = 250\text{ mA}$ | 46 | | |
| Output noise spectral density | $V_I = 6\text{ V}$, $f = 120\text{ Hz}$ | 2 | | | $\mu\text{V}/\sqrt{\text{Hz}}$ |
| Output noise voltage | $V_I = 6\text{ V}$, $10\text{ Hz} \leq f \leq 100\text{ kHz}$, $\text{CSR}^\dagger = 1\text{ }\Omega$ | $C_O = 4.7\text{ }\mu\text{F}$ | 390 | | μV_{rms} |
| | | $C_O = 10\text{ }\mu\text{F}$ | 300 | | |
| | | $C_O = 100\text{ }\mu\text{F}$ | 175 | | |
| PG hysteresis voltage | $V_I = 6\text{ V}$ | 50 | | | mV |
| PG output low voltage | $V_I = 4.25\text{ V}$, $I_{\text{PG}} = 1.2\text{ mA}$ | 0.19 | | | V |

† CSR refers to the total series resistance, including the ESR of the capacitor, any series resistance added externally, and PWB trace resistance to C_O .

‡ Pulse-testing techniques are used to maintain virtual junction temperature as close as possible to ambient temperature; thermal effects must be taken into account separately.



TYPICAL CHARACTERISTICS

Table of Graphs

| | | FIGURE | |
|----------------------|---|--|----|
| I_Q | Quiescent current | vs Output current | 5 |
| | | vs Input voltage | 6 |
| ΔI_Q^\dagger | Change in quiescent current | vs Free-air temperature | 7 |
| V_{DO} | Dropout voltage | vs Output current | 8 |
| ΔV_{DO} | Change in dropout voltage | vs Free-air temperature | 9 |
| V_{DO} | Dropout voltage (TPS7201 only) | vs Output current | 10 |
| $r_{DS(on)}$ | Pass-element series resistance | vs Input voltage | 11 |
| ΔV_O | Change in output voltage | vs Free-air temperature | 12 |
| V_O | Output voltage | vs Input voltage | 13 |
| | Line regulation (TPS7201, TPS7233, TPS7248, TPS7250) | | 14 |
| | Load regulation (TPS7225, TPS7233, TPS7248, TPS7250) | | 15 |
| $V_{O(PG)}$ | Power-good (PG) voltage | vs Output voltage | 16 |
| $r_{DS(on)PG}$ | Power-good (PG) on-resistance | vs Input voltage | 17 |
| V_I | Minimum input voltage for valid PG | vs Free-air temperature | 18 |
| | Output voltage response from enable (\overline{EN}) | | 19 |
| | Load transient response (TPS7201/TPS7233) | | 20 |
| | Load transient response (TPS7248/TPS7250) | | 21 |
| | Line transient response (TPS7201) | | 22 |
| | Line transient response (TPS7233) | | 23 |
| | Line transient response (TPS7248/TPS7250) | | 24 |
| | Ripple rejection | vs Frequency | 25 |
| | Output Spectral Noise Density | vs Frequency | 26 |
| | Compensation series resistance (CSR) | vs Output current ($C_O = 4.7 \mu F$) | 27 |
| | | vs Added ceramic capacitance ($C_O = 4.7 \mu F$) | 28 |
| | | vs Output current ($C_O = 10 \mu F$) | 29 |
| | | vs Added ceramic capacitance ($C_O = 10 \mu F$) | 30 |

† This symbol is not currently listed within EIA or JEDEC standards for semiconductor symbology.

TYPICAL CHARACTERISTICS

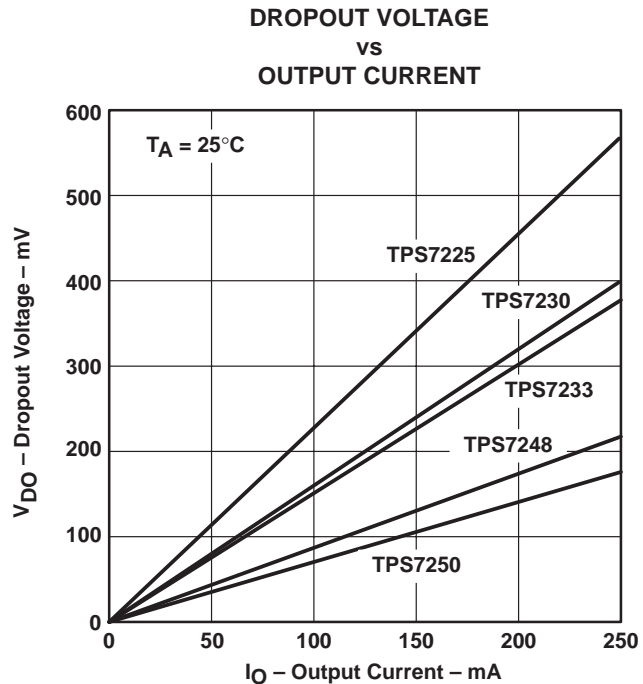
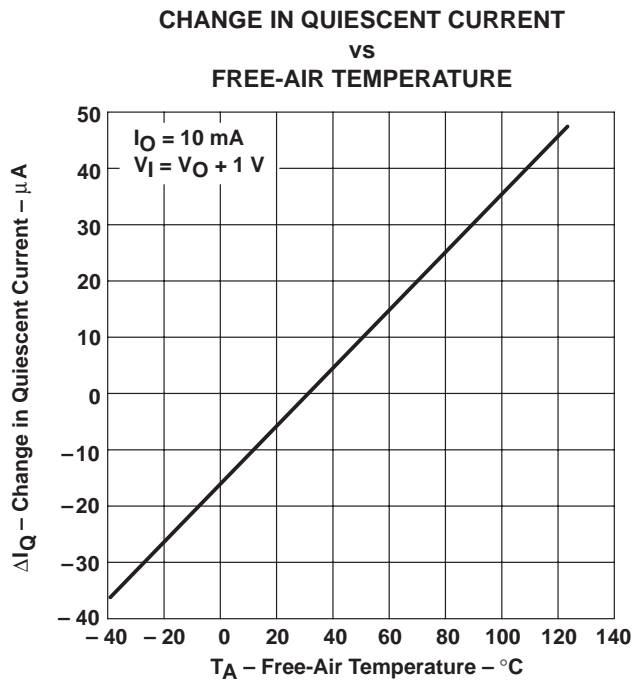
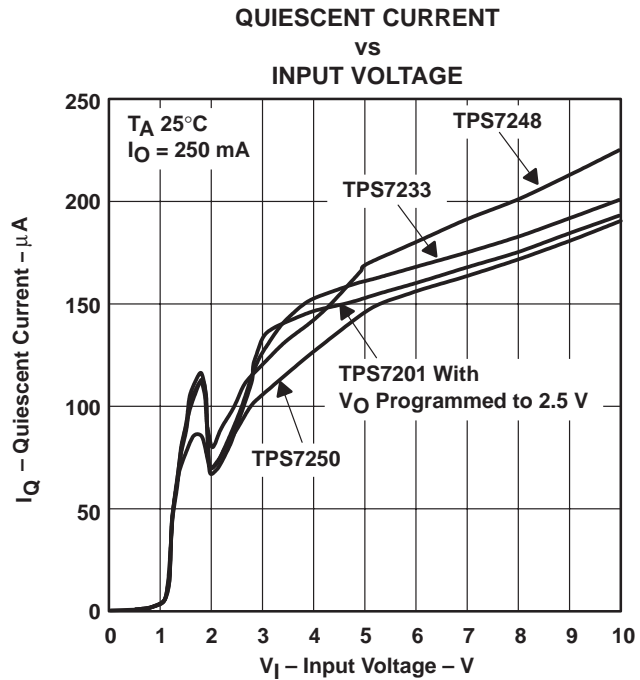
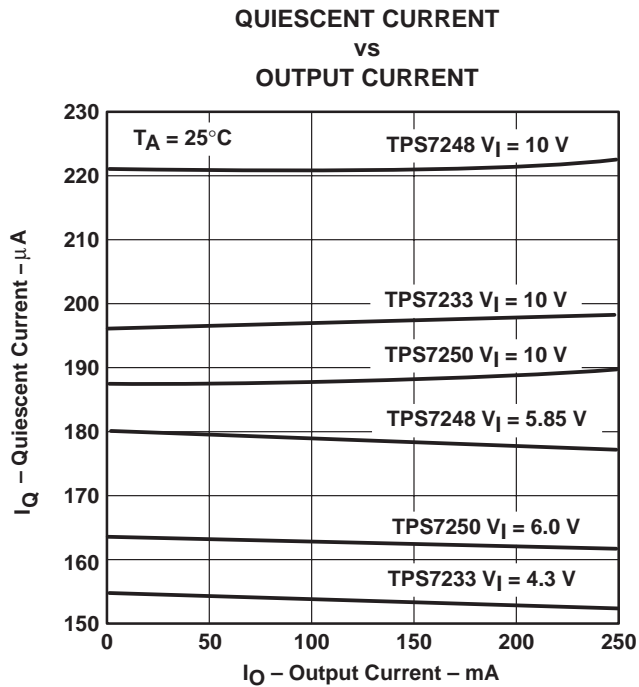

TYPICAL CHARACTERISTICS

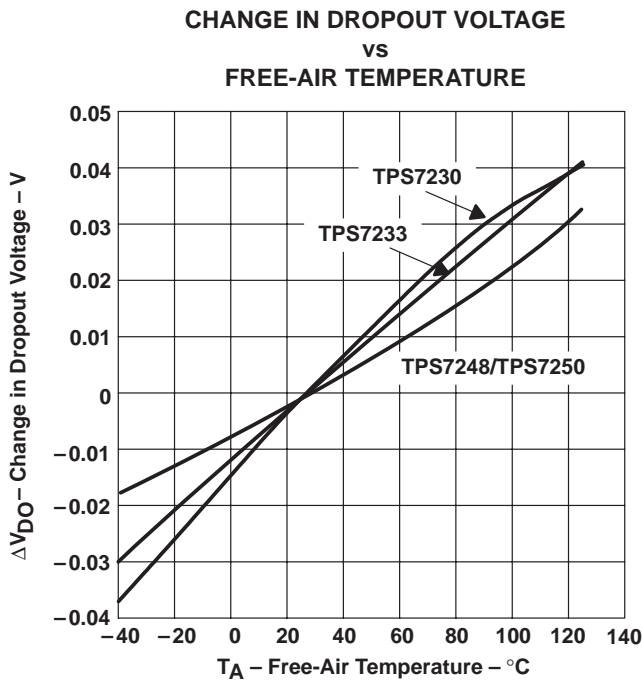
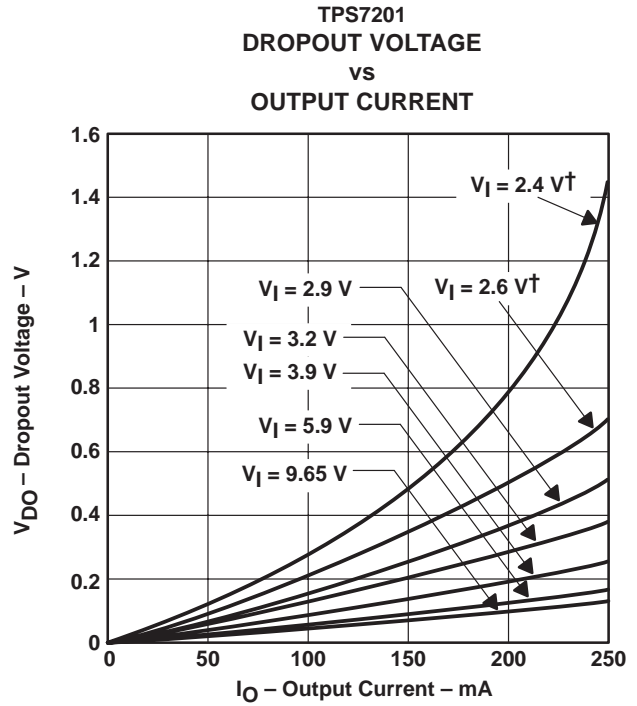

Figure 9



† This voltage is not recommended.

Figure 10

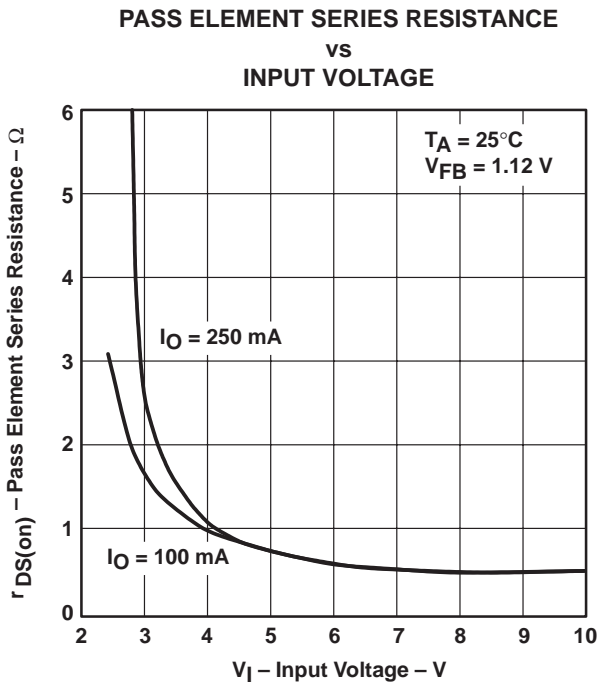

Figure 11

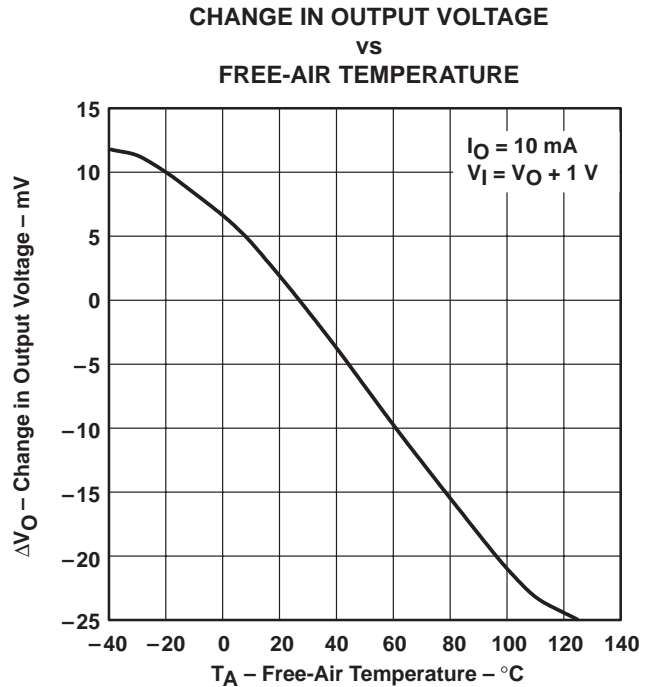

Figure 12

TYPICAL CHARACTERISTICS

OUTPUT VOLTAGE
 vs
 INPUT VOLTAGE

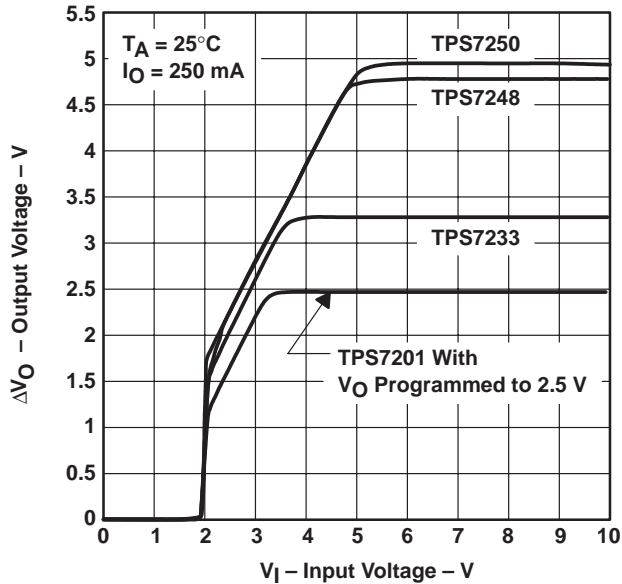

Figure 13

LINE REGULATION

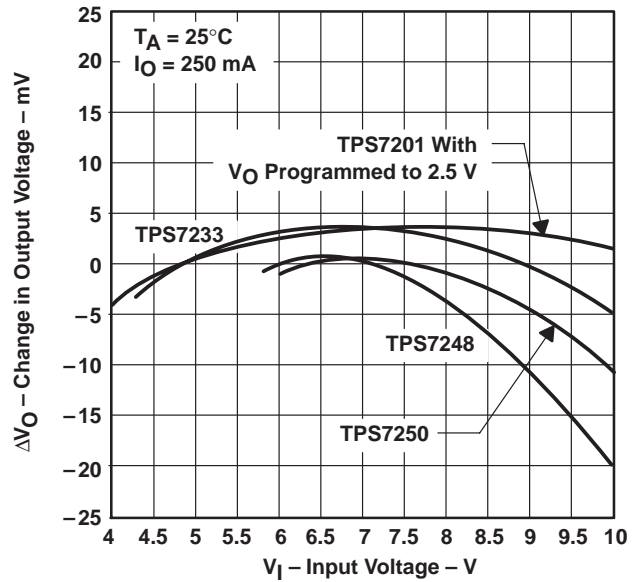

Figure 14

LOAD REGULATION

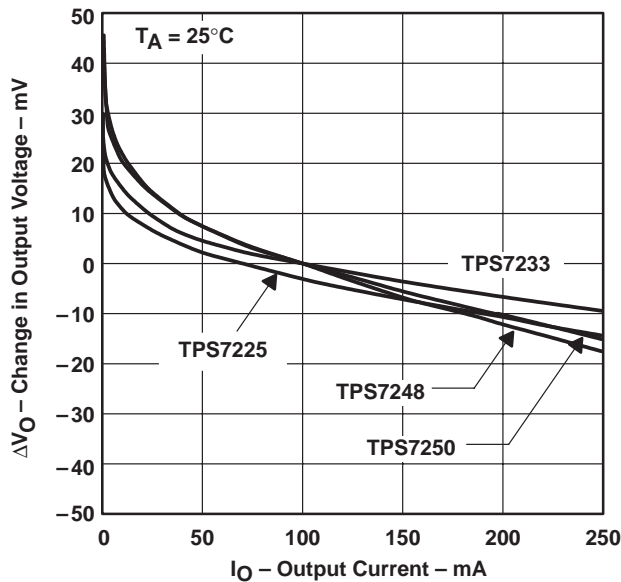
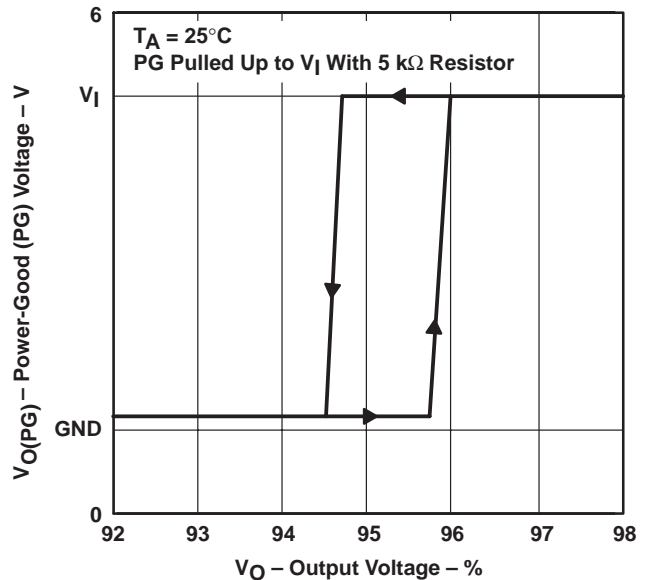

Figure 15

POWER-GOOD (PG) VOLTAGE
 vs
 OUTPUT VOLTAGE†



† V_O as a percent of $V_{O\text{nom}}$.

Figure 16

TYPICAL CHARACTERISTICS

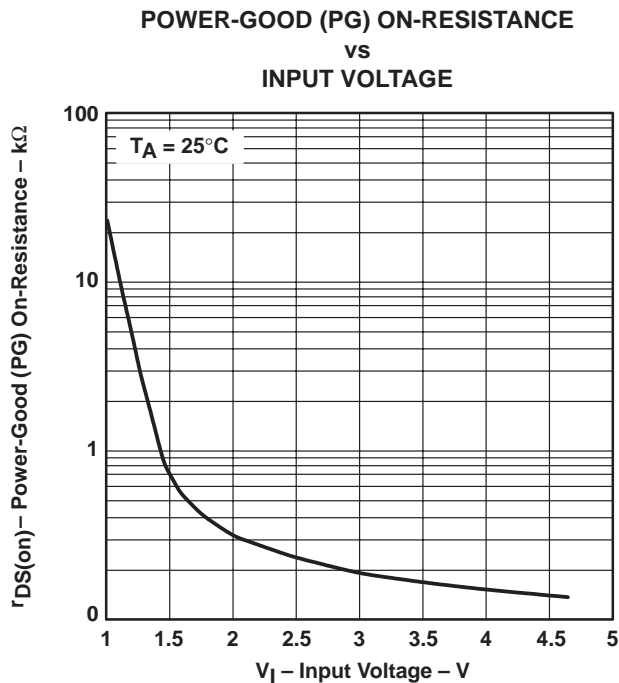

Figure 17

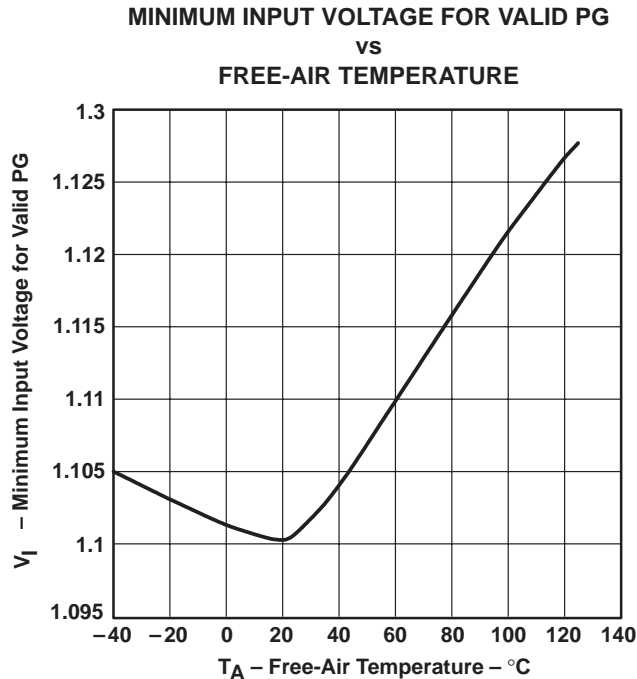

Figure 18

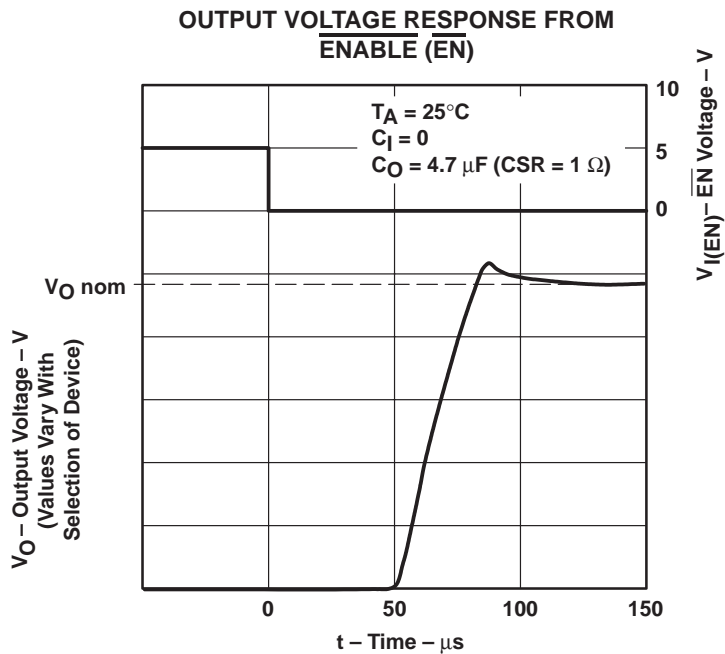

Figure 19

TYPICAL CHARACTERISTICS

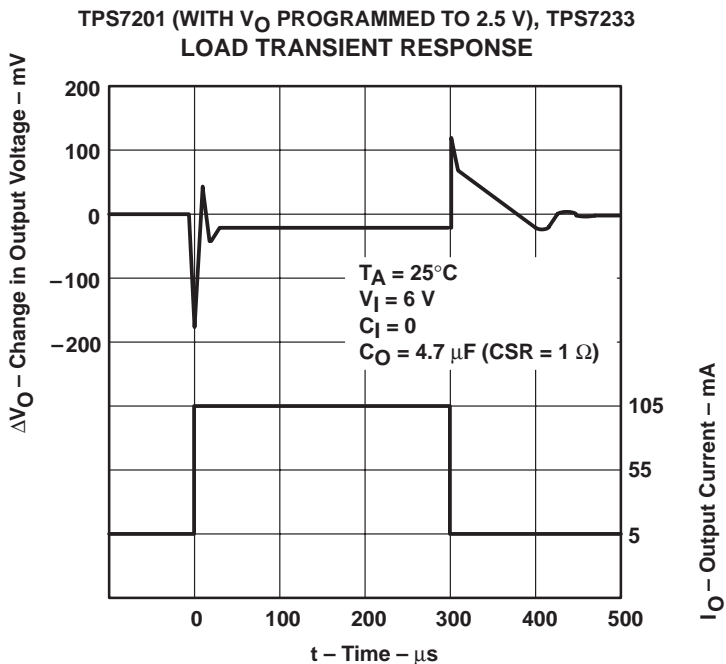

Figure 20

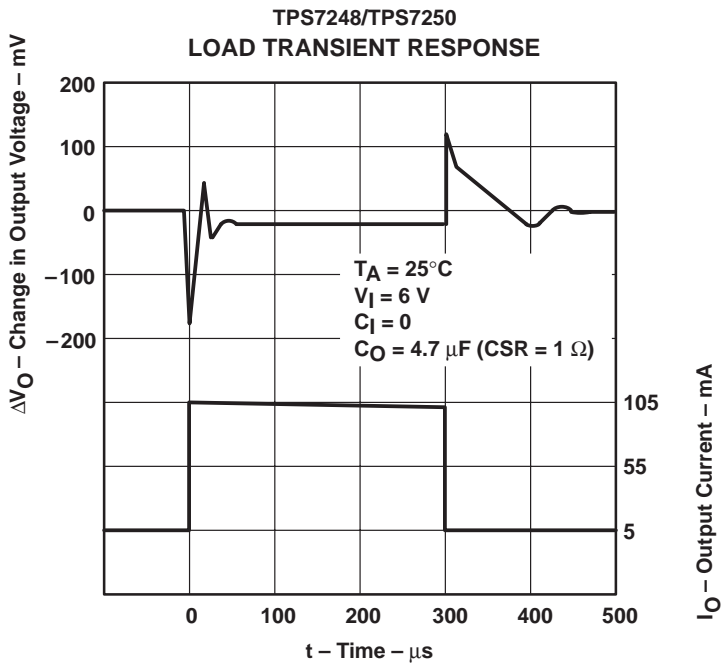

Figure 21

TYPICAL CHARACTERISTICS

TPS7201 WITH V_O PROGRAMMED TO 2.5 V
 LINE TRANSIENT RESPONSE

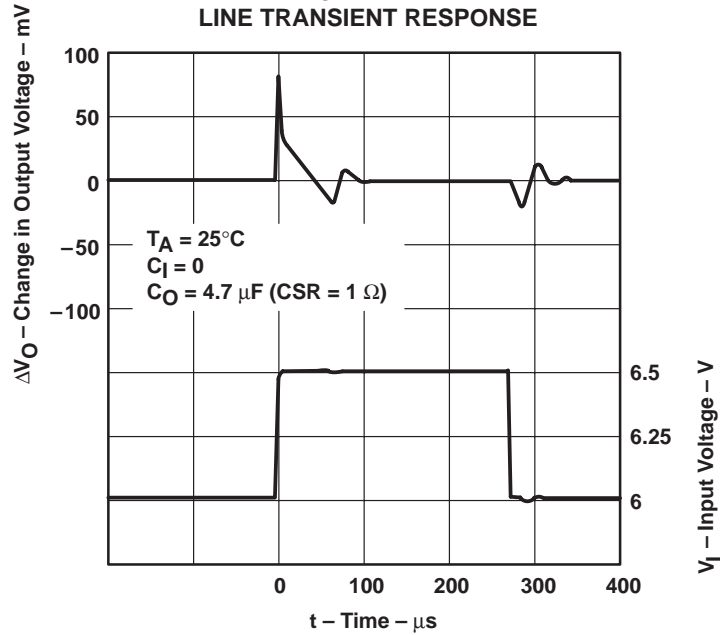

Figure 22

TPS7233
 LINE TRANSIENT RESPONSE

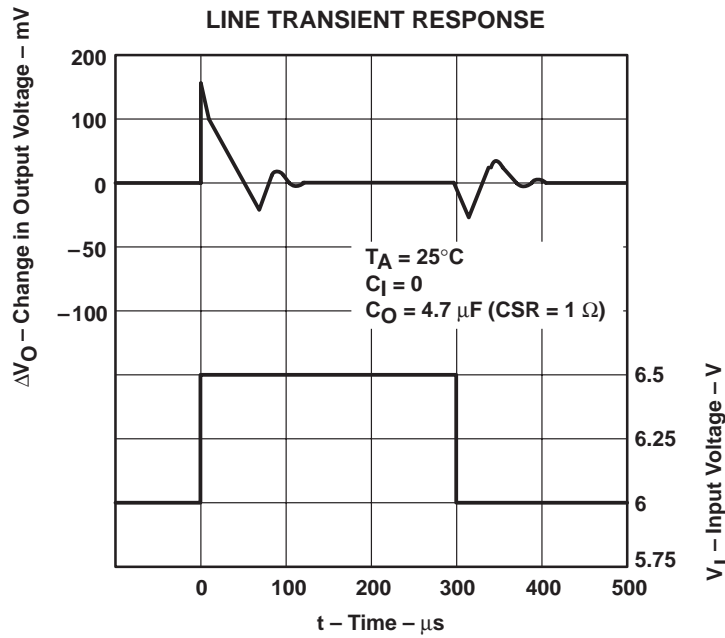

Figure 23

TYPICAL CHARACTERISTICS

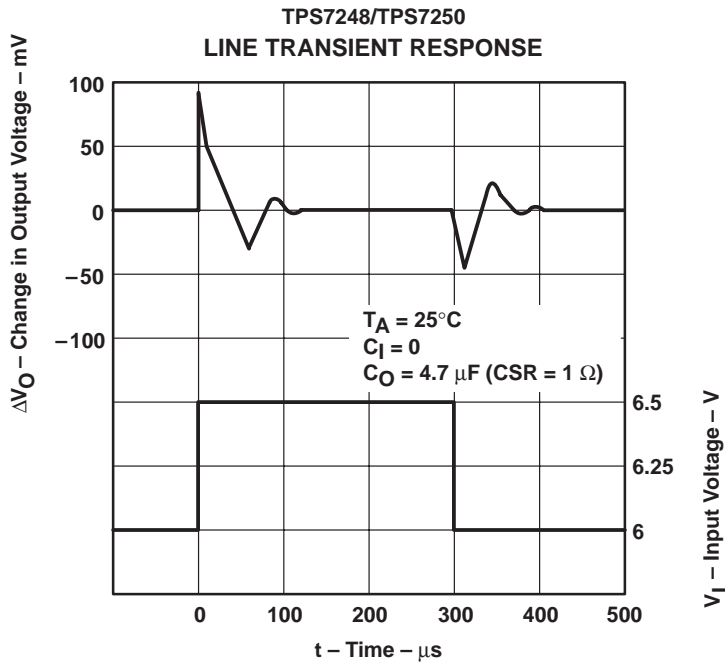

Figure 24

RIPPLE REJECTION
 VS
 FREQUENCY

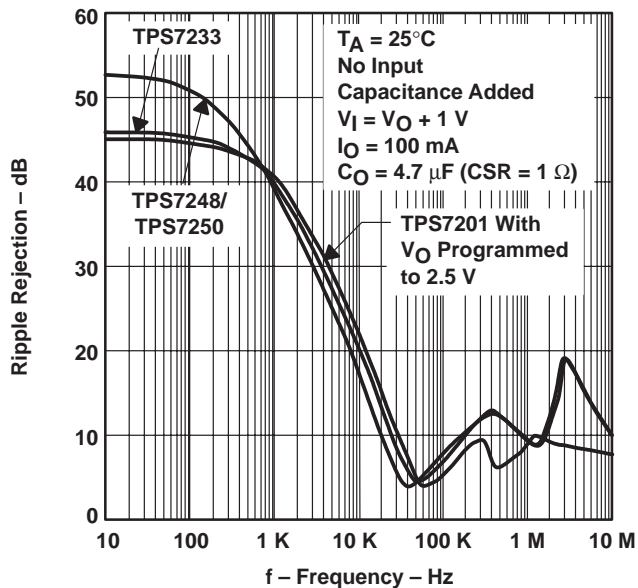

Figure 25

OUTPUT SPECTRAL NOISE DENSITY
 VS
 FREQUENCY

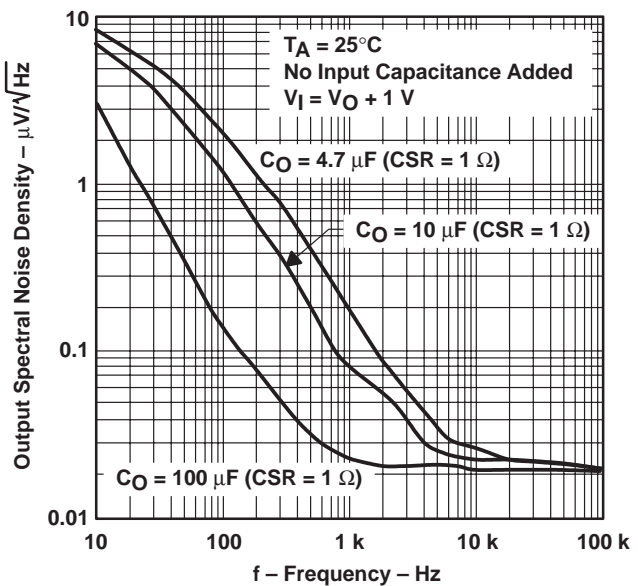

Figure 26

TYPICAL CHARACTERISTICS

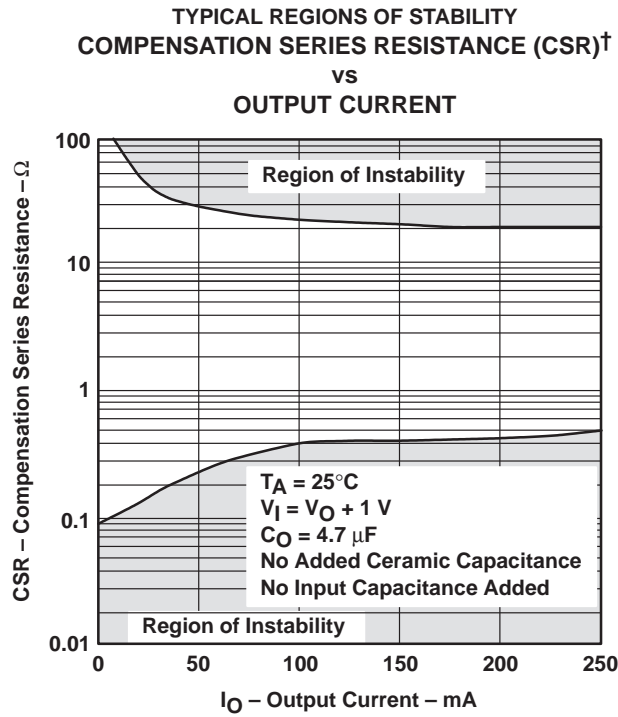

Figure 27

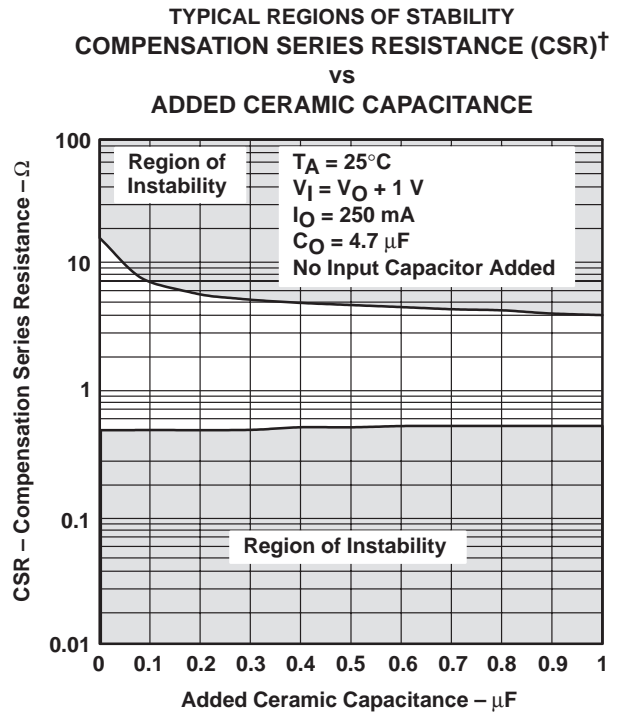

Figure 28

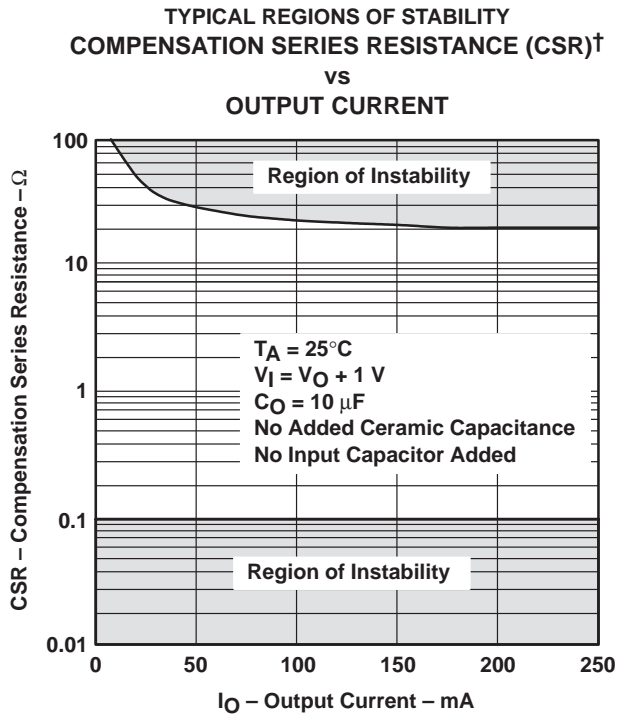

Figure 29

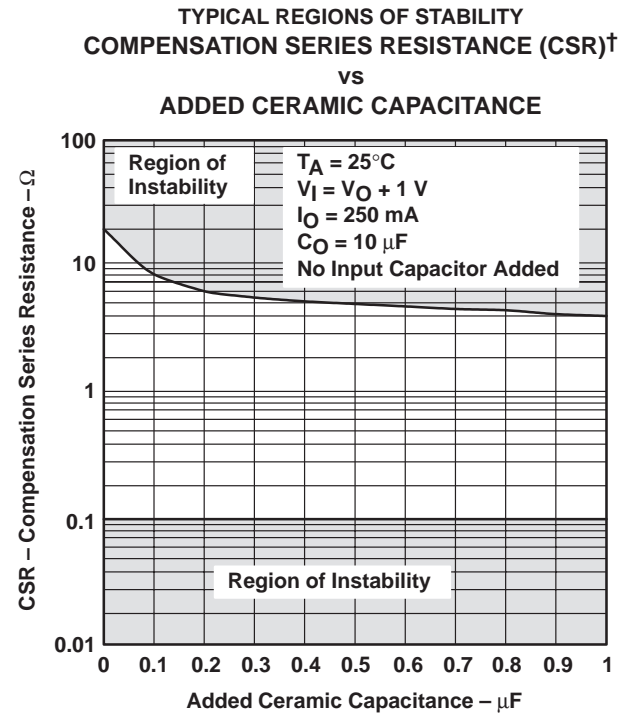

Figure 30

[†] CSR refers to the total series resistance, including the ESR of the capacitor, any series resistance added externally, and PWB trace resistance to C_O .

TPS7201Q, TPS7225Q, TPS7230Q
TPS7233Q, TPS7248Q, TPS7250Q, TPS72xxY
MICROPOWER LOW-DROPOUT (LDO) VOLTAGE REGULATORS

SLVS102G – MARCH 1995 – REVISED JUNE 2000

APPLICATION INFORMATION

The design of the TPS72xx family of low-dropout (LDO) regulators is based on the higher-current TPS71xx family. These new families of regulators have been optimized for use in battery-operated equipment and feature extremely low dropout voltages, low supply currents that remain constant over the full-output-current range of the device, and an enable input to reduce supply currents to less than 0.5 μA when the regulator is turned off.

device operation

The TPS72xx uses a PMOS pass element to dramatically reduce both dropout voltage and supply current over more conventional PNP-pass-element LDO designs. The PMOS transistor is a voltage-controlled device that, unlike a PNP transistor, does not require increased drive current as output current increases. Supply current in the TPS72xx is essentially constant from no-load to maximum.

Current limiting and thermal protection prevent damage by excessive output current and/or power dissipation. The device switches into a constant-current mode at approximately 1 A; further load increases reduce the output voltage instead of increasing the output current. The thermal protection shuts the regulator off if the junction temperature rises above 165°C. Recovery is automatic when the junction temperature drops approximately 5°C below the high temperature trip point. The PMOS pass element includes a back diode that safely conducts reverse current when the input voltage level drops below the output voltage level.

A logic high on the enable input, $\overline{\text{EN}}$, shuts off the output and reduces the supply current to less than 0.5 μA . $\overline{\text{EN}}$ should be grounded in applications where the shutdown feature is not used.

Power good (PG) is an open-drain output signal used to indicate output-voltage status. A comparator circuit continuously monitors the output voltage. When the output drops to approximately 95% of its nominal regulated value, the comparator turns on and pulls PG low.

Transient loads or line pulses can also cause activation of PG if proper care is not taken in selecting the input and output capacitors. Load transients that are faster than 5 μs can cause a signal on PG if high-ESR output capacitors (greater than approximately 7 Ω) are used. A 1- μs transient causes a PG signal when using an output capacitor with greater than 3.5 Ω of ESR. It is interesting to note that the output-voltage spike during the transient can drop well below the reset threshold and still not trip if the transient duration is short. A 1- μs transient must drop at least 500 mV below the threshold before tripping the PG circuit. A 2- μs transient trips PG at just 400 mV below the threshold. Lower-ESR output capacitors help by reducing the drop in output voltage during a transient and should be used when fast transients are expected.

A typical application circuit is shown in Figure 31.



APPLICATION INFORMATION

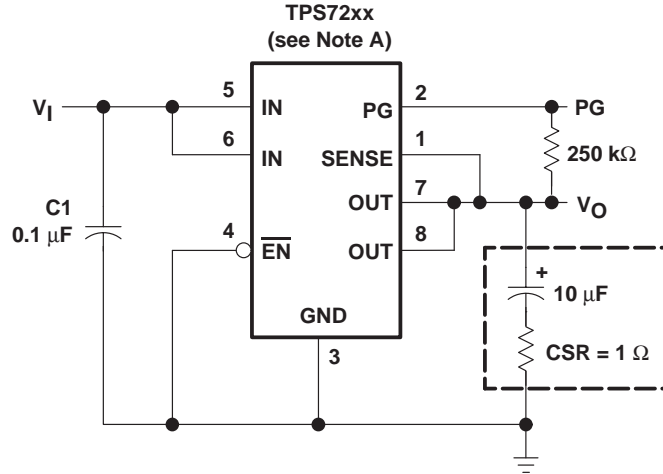

NOTE A: TPS7225, TPS7230, TPS7233, TPS7248, TPS7250
 (fixed-voltage options).

Figure 31. Typical Application Circuit

external capacitor requirements

Although not required, a 0.047- μF to 0.1- μF ceramic bypass input capacitor, connected between IN and GND and located close to the TPS72xx, is recommended to improve transient response and noise rejection. A higher-value electrolytic input capacitor may be necessary if large, fast-rise-time load transients are anticipated and the device is located several inches from the power source.

An output capacitor is required to stabilize the internal feedback loop. For most applications, a 10- μF to 15- μF solid-tantalum capacitor with a 0.5- Ω resistor (see capacitor selection table) in series is sufficient. The maximum capacitor ESR should be limited to 1.3 Ω to allow for ESR doubling at cold temperatures. Figure 32 shows the transient response of a 5-mA to 85-mA load using a 10- μF output capacitor with a total ESR of 1.7 Ω .

A 4.7- μF solid-tantalum capacitor in series with a 1- Ω resistor may also be used (see Figures 27 and 28) provided the ESR of the capacitor does not exceed 1 Ω at room temperature and 2 Ω over the full operating temperature range.

APPLICATION INFORMATION

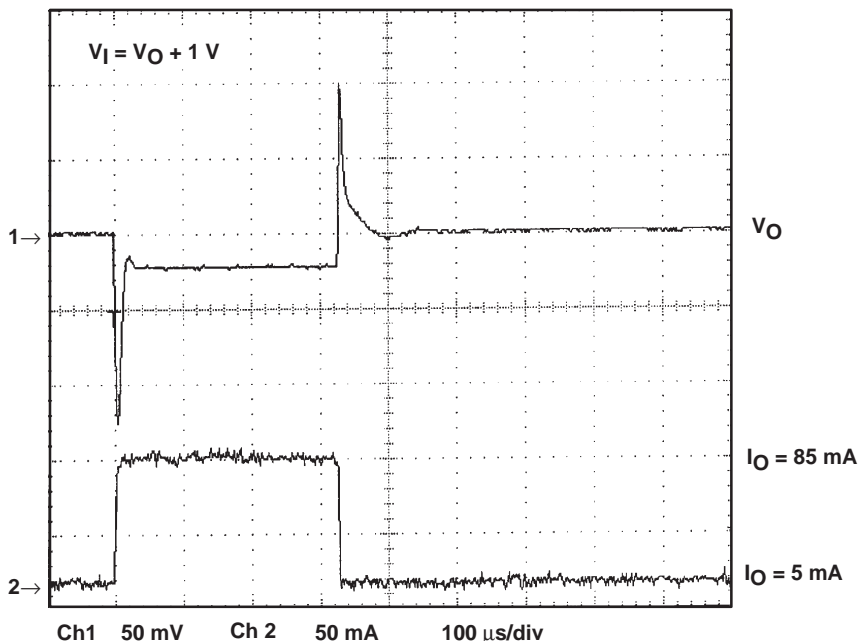

Figure 32. Load Transient Response (CSR total = 1.7 Ω), TPS7248Q

A partial listing of surface-mount capacitors usable with the TPS72xx family is provided below. This information (along with the stability graphs, Figures 27 through 30) is included to assist the designer in selecting suitable capacitors.

CAPACITOR SELECTION

| PART NO. | MFR. | VALUE | MAX ESR† | SIZE (H × L × W)† |
|-----------------|---------|-------------|----------|-------------------|
| 592D156X0020R2T | Sprague | 15 μF, 20 V | 1.1 | 1.2 × 7.2 × 6 |
| 595D156X0025C2T | Sprague | 15 μF, 25 V | 1 | 2.5 × 7.1 × 3.2 |
| 595D106X0025C2T | Sprague | 10 μF, 25 V | 1.2 | 2.5 × 7.1 × 3.2 |
| 695D106X0035G2T | Sprague | 10 μF, 35 V | 1.3 | 2.5 × 7.6 × 2.5 |

† Size is in mm. ESR is maximum resistance in ohms at 100 kHz and T_A = 25°C. Listings are sorted by height.

sense-pin connection

SENSE must be connected to OUT for proper operation of the regulator. Normally this connection should be as short as possible; however, remote sense may be implemented in critical applications when proper care of the circuit path is exercised. SENSE internally connects to a high-impedance wide-bandwidth amplifier through a resistor-divider network, and any noise pickup on the PCB trace will feed through to the regulator output. SENSE must be routed to minimize noise pickup. Filtering SENSE using an RC network is not recommended because of the possibility of inducing regulator instability.

APPLICATION INFORMATION

output voltage programming

The output voltage of the TPS7201 adjustable regulator is programmed using an external resistor divider as shown in Figure 33. The output voltage is calculated using:

$$V_O = V_{ref} \cdot \left(1 + \frac{R1}{R2}\right) \quad (1)$$

Where:

$$V_{ref} = 1.188 \text{ V typ (the internal reference voltage)}$$

Resistors R1 and R2 should be chosen for approximately 7- μ A divider current. Lower value resistors can be used but offer no inherent advantage and waste more power. Higher values should be avoided as leakage currents at FB increase the output voltage error. The recommended design procedure is to choose R2 = 169 k Ω to set the divider current at 7 μ A and then calculate R1 using:

$$R1 = \left(\frac{V_O}{V_{ref}} - 1\right) \cdot R2 \quad (2)$$

**OUTPUT VOLTAGE
PROGRAMMING GUIDE**

| OUTPUT VOLTAGE (V) | DIVIDER RESISTANCE (k Ω) [†] | |
|--------------------|---|-----|
| | R1 | R2 |
| 2.5 | 191 | 169 |
| 3.3 | 309 | 169 |
| 3.6 | 348 | 169 |
| 4 | 402 | 169 |
| 5 | 549 | 169 |
| 6.4 | 750 | 169 |

[†] 1% values shown.

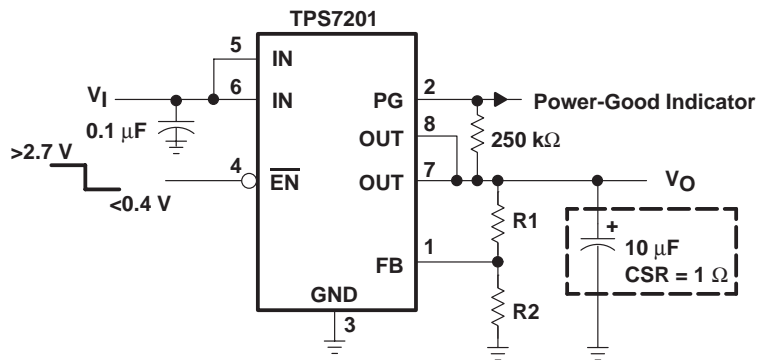

Figure 33. TPS7201 Adjustable LDO Regulator Programming

APPLICATION INFORMATION

power dissipation and junction temperature

Specified regulator operation is assured to a junction temperature of 125°C; the maximum junction temperature allowable to avoid damaging the device is 150°C. These restrictions limit the power dissipation that the regulator can handle in any given application. To ensure the junction temperature is within acceptable limits, calculate the maximum allowable dissipation, $P_{D(max)}$, and the actual dissipation, P_D , which must be less than or equal to $P_{D(max)}$.

The maximum-power-dissipation limit is determined using the following equation:

$$P_{D(max)} = \frac{T_{Jmax} - T_A}{R_{\theta JA}}$$

Where:

T_{Jmax} is the maximum allowable junction temperature, i.e., 150°C absolute maximum and 125°C recommended operating temperature.

$R_{\theta JA}$ is the thermal resistance junction-to-ambient for the package, i.e., 172°C/W for the 8-terminal SOIC and 238°C/W for the 8-terminal TSSOP.

T_A is the ambient temperature.

The regulator dissipation is calculated using:

$$P_D = (V_I - V_O) \cdot I_O$$

Power dissipation resulting from quiescent current is negligible.

regulator protection

The TPS72xx PMOS-pass transistor has a built-in back diode that safely conducts reverse currents when the input voltage drops below the output voltage (e.g., during power down). Current is conducted from the output to the input and is not internally limited. If extended reverse voltage is anticipated, external limiting might be appropriate.

The TPS72xx also features internal current limiting and thermal protection. During normal operation, the TPS72xx limits output current to approximately 1 A. When current limiting engages, the output voltage scales back linearly until the overcurrent condition ends. While current limiting is designed to prevent gross device failure, care should be taken not to exceed the power dissipation ratings of the package. If the temperature of the device exceeds 165°C, thermal-protection circuitry shuts it down. Once the device has cooled, regulator operation resumes.

PACKAGING INFORMATION

| Orderable Device | Status (1) | Package Type | Package Drawing | Pins | Package Qty | Eco Plan (2) | Lead/Ball Finish (6) | MSL Peak Temp (3) | Op Temp (°C) | Device Marking (4/5) | Samples |
|------------------|---------------|--------------|--------------------|------|----------------|----------------------------|-------------------------|----------------------|--------------|-------------------------|-------------------------|
| TPS7201QD | ACTIVE | SOIC | D | 8 | 75 | Green (RoHS & no Sb/Br) | CU NIPDAU | Level-1-260C-UNLIM | -40 to 125 | 7201Q | Samples |
| TPS7201QDG4 | ACTIVE | SOIC | D | 8 | 75 | Green (RoHS & no Sb/Br) | CU NIPDAU | Level-1-260C-UNLIM | -40 to 125 | 7201Q | Samples |
| TPS7201QDR | ACTIVE | SOIC | D | 8 | 2500 | Green (RoHS & no Sb/Br) | CU NIPDAU | Level-1-260C-UNLIM | -40 to 125 | 7201Q | Samples |
| TPS7201QDRG4 | ACTIVE | SOIC | D | 8 | 2500 | Green (RoHS & no Sb/Br) | CU NIPDAU | Level-1-260C-UNLIM | -40 to 125 | 7201Q | Samples |
| TPS7201QP | ACTIVE | PDIP | P | 8 | 50 | Pb-Free (RoHS) | CU NIPDAU | N / A for Pkg Type | -40 to 125 | TPS7201QP | Samples |
| TPS7201QPW | ACTIVE | TSSOP | PW | 8 | 150 | Green (RoHS & no Sb/Br) | CU NIPDAU | Level-1-260C-UNLIM | -40 to 125 | PT7201 | Samples |
| TPS7201QPWG4 | ACTIVE | TSSOP | PW | 8 | 150 | Green (RoHS & no Sb/Br) | CU NIPDAU | Level-1-260C-UNLIM | -40 to 125 | PT7201 | Samples |
| TPS7201QPWLE | OBSOLETE | TSSOP | PW | 8 | | TBD | Call TI | Call TI | -40 to 125 | | |
| TPS7201QPWR | ACTIVE | TSSOP | PW | 8 | 2000 | Green (RoHS & no Sb/Br) | CU NIPDAU | Level-1-260C-UNLIM | -40 to 125 | PT7201 | Samples |
| TPS7225QD | ACTIVE | SOIC | D | 8 | 75 | Green (RoHS & no Sb/Br) | CU NIPDAU | Level-1-260C-UNLIM | -55 to 150 | 7225Q | Samples |
| TPS7225QDG4 | ACTIVE | SOIC | D | 8 | 75 | Green (RoHS & no Sb/Br) | CU NIPDAU | Level-1-260C-UNLIM | -55 to 150 | 7225Q | Samples |
| TPS7225QDR | ACTIVE | SOIC | D | 8 | 2500 | Green (RoHS & no Sb/Br) | CU NIPDAU | Level-1-260C-UNLIM | -55 to 150 | 7225Q | Samples |
| TPS7225QDRG4 | ACTIVE | SOIC | D | 8 | 2500 | Green (RoHS & no Sb/Br) | CU NIPDAU | Level-1-260C-UNLIM | -55 to 150 | 7225Q | Samples |
| TPS7225QP | ACTIVE | PDIP | P | 8 | 50 | Pb-Free (RoHS) | CU NIPDAU | N / A for Pkg Type | -55 to 150 | TPS7225QP | Samples |
| TPS7225QPWR | ACTIVE | TSSOP | PW | 8 | 2000 | Green (RoHS & no Sb/Br) | CU NIPDAU | Level-1-260C-UNLIM | -55 to 150 | PT7225 | Samples |
| TPS7230QD | ACTIVE | SOIC | D | 8 | 75 | Green (RoHS & no Sb/Br) | CU NIPDAU | Level-1-260C-UNLIM | -55 to 150 | 7230Q | Samples |
| TPS7230QP | ACTIVE | PDIP | P | 8 | 50 | Pb-Free (RoHS) | CU NIPDAU | N / A for Pkg Type | -40 to 125 | TPS7230QP | Samples |

| Orderable Device | Status (1) | Package Type | Package Drawing | Pins | Package Qty | Eco Plan (2) | Lead/Ball Finish (6) | MSL Peak Temp (3) | Op Temp (°C) | Device Marking (4/5) | Samples |
|------------------|---------------|--------------|-----------------|------|-------------|-------------------------|-------------------------|----------------------|--------------|-------------------------|-------------------------|
| TPS7230QPWR | ACTIVE | TSSOP | PW | 8 | 2000 | Green (RoHS & no Sb/Br) | CU NIPDAU | Level-1-260C-UNLIM | -40 to 125 | PT7230 | Samples |
| TPS7233QD | ACTIVE | SOIC | D | 8 | 75 | Green (RoHS & no Sb/Br) | CU NIPDAU | Level-1-260C-UNLIM | -40 to 125 | 7233Q | Samples |
| TPS7233QDG4 | ACTIVE | SOIC | D | 8 | 75 | Green (RoHS & no Sb/Br) | CU NIPDAU | Level-1-260C-UNLIM | -40 to 125 | 7233Q | Samples |
| TPS7233QDR | ACTIVE | SOIC | D | 8 | 2500 | Green (RoHS & no Sb/Br) | CU NIPDAU | Level-1-260C-UNLIM | -40 to 125 | 7233Q | Samples |
| TPS7233QDRG4 | ACTIVE | SOIC | D | 8 | 2500 | Green (RoHS & no Sb/Br) | CU NIPDAU | Level-1-260C-UNLIM | -40 to 125 | 7233Q | Samples |
| TPS7233QP | ACTIVE | PDIP | P | 8 | 50 | Pb-Free (RoHS) | CU NIPDAU | N / A for Pkg Type | -40 to 125 | TPS7233QP | Samples |
| TPS7233QPE4 | ACTIVE | PDIP | P | 8 | 50 | Pb-Free (RoHS) | CU NIPDAU | N / A for Pkg Type | -40 to 125 | TPS7233QP | Samples |
| TPS7233QPWLE | OBSOLETE | TSSOP | PW | 8 | | TBD | Call TI | Call TI | -40 to 125 | | |
| TPS7233QPWR | ACTIVE | TSSOP | PW | 8 | 2000 | Green (RoHS & no Sb/Br) | CU NIPDAU | Level-1-260C-UNLIM | -40 to 125 | PT7233 | Samples |
| TPS7248QD | ACTIVE | SOIC | D | 8 | 75 | Green (RoHS & no Sb/Br) | CU NIPDAU | Level-1-260C-UNLIM | -40 to 125 | 7248Q | Samples |
| TPS7248QDG4 | ACTIVE | SOIC | D | 8 | 75 | Green (RoHS & no Sb/Br) | CU NIPDAU | Level-1-260C-UNLIM | -40 to 125 | 7248Q | Samples |
| TPS7248QP | ACTIVE | PDIP | P | 8 | 50 | Pb-Free (RoHS) | CU NIPDAU | N / A for Pkg Type | -40 to 125 | TPS7248QP | Samples |
| TPS7248QPWLE | OBSOLETE | TSSOP | PW | 8 | | TBD | Call TI | Call TI | -40 to 125 | | |
| TPS7250QD | ACTIVE | SOIC | D | 8 | 75 | Green (RoHS & no Sb/Br) | CU NIPDAU | Level-1-260C-UNLIM | -40 to 125 | 7250Q | Samples |
| TPS7250QDG4 | ACTIVE | SOIC | D | 8 | 75 | Green (RoHS & no Sb/Br) | CU NIPDAU | Level-1-260C-UNLIM | -40 to 125 | 7250Q | Samples |
| TPS7250QDR | ACTIVE | SOIC | D | 8 | 2500 | Green (RoHS & no Sb/Br) | CU NIPDAU | Level-1-260C-UNLIM | -40 to 125 | 7250Q | Samples |
| TPS7250QDRG4 | ACTIVE | SOIC | D | 8 | 2500 | Green (RoHS & no Sb/Br) | CU NIPDAU | Level-1-260C-UNLIM | -40 to 125 | 7250Q | Samples |
| TPS7250QP | ACTIVE | PDIP | P | 8 | 50 | Pb-Free (RoHS) | CU NIPDAU | N / A for Pkg Type | -40 to 125 | TPS7250QP | Samples |
| TPS7250QPW | ACTIVE | TSSOP | PW | 8 | 150 | Green (RoHS & no Sb/Br) | CU NIPDAU | Level-1-260C-UNLIM | -40 to 125 | PT7250 | Samples |

| Orderable Device | Status (1) | Package Type | Package Drawing | Pins | Package Qty | Eco Plan (2) | Lead/Ball Finish (6) | MSL Peak Temp (3) | Op Temp (°C) | Device Marking (4/5) | Samples |
|------------------|---------------|--------------|-----------------|------|-------------|-------------------------|-------------------------|----------------------|--------------|-------------------------|---------|
| TPS7250QPWLE | OBSOLETE | TSSOP | PW | 8 | | TBD | Call TI | Call TI | -40 to 125 | | |
| TPS7250QPWR | ACTIVE | TSSOP | PW | 8 | 2000 | Green (RoHS & no Sb/Br) | CU NIPDAU | Level-1-260C-UNLIM | -40 to 125 | PT7250 | Samples |

(1) The marketing status values are defined as follows:

ACTIVE: Product device recommended for new designs.

LIFEBUY: TI has announced that the device will be discontinued, and a lifetime-buy period is in effect.

NRND: Not recommended for new designs. Device is in production to support existing customers, but TI does not recommend using this part in a new design.

PREVIEW: Device has been announced but is not in production. Samples may or may not be available.

OBSOLETE: TI has discontinued the production of the device.

(2) Eco Plan - The planned eco-friendly classification: Pb-Free (RoHS), Pb-Free (RoHS Exempt), or Green (RoHS & no Sb/Br) - please check <http://www.ti.com/productcontent> for the latest availability information and additional product content details.

TBD: The Pb-Free/Green conversion plan has not been defined.

Pb-Free (RoHS): TI's terms "Lead-Free" or "Pb-Free" mean semiconductor products that are compatible with the current RoHS requirements for all 6 substances, including the requirement that lead not exceed 0.1% by weight in homogeneous materials. Where designed to be soldered at high temperatures, TI Pb-Free products are suitable for use in specified lead-free processes.

Pb-Free (RoHS Exempt): This component has a RoHS exemption for either 1) lead-based flip-chip solder bumps used between the die and package, or 2) lead-based die adhesive used between the die and leadframe. The component is otherwise considered Pb-Free (RoHS compatible) as defined above.

Green (RoHS & no Sb/Br): TI defines "Green" to mean Pb-Free (RoHS compatible), and free of Bromine (Br) and Antimony (Sb) based flame retardants (Br or Sb do not exceed 0.1% by weight in homogeneous material)

(3) MSL, Peak Temp. - The Moisture Sensitivity Level rating according to the JEDEC industry standard classifications, and peak solder temperature.

(4) There may be additional marking, which relates to the logo, the lot trace code information, or the environmental category on the device.

(5) Multiple Device Markings will be inside parentheses. Only one Device Marking contained in parentheses and separated by a "~" will appear on a device. If a line is indented then it is a continuation of the previous line and the two combined represent the entire Device Marking for that device.

(6) Lead/Ball Finish - Orderable Devices may have multiple material finish options. Finish options are separated by a vertical ruled line. Lead/Ball Finish values may wrap to two lines if the finish value exceeds the maximum column width.

Important Information and Disclaimer: The information provided on this page represents TI's knowledge and belief as of the date that it is provided. TI bases its knowledge and belief on information provided by third parties, and makes no representation or warranty as to the accuracy of such information. Efforts are underway to better integrate information from third parties. TI has taken and continues to take reasonable steps to provide representative and accurate information but may not have conducted destructive testing or chemical analysis on incoming materials and chemicals. TI and TI suppliers consider certain information to be proprietary, and thus CAS numbers and other limited information may not be available for release.

In no event shall TI's liability arising out of such information exceed the total purchase price of the TI part(s) at issue in this document sold by TI to Customer on an annual basis.

TAPE AND REEL INFORMATION

QUADRANT ASSIGNMENTS FOR PIN 1 ORIENTATION IN TAPE

*All dimensions are nominal

| Device | Package Type | Package Drawing | Pins | SPQ | Reel Diameter (mm) | Reel Width W1 (mm) | A0 (mm) | B0 (mm) | K0 (mm) | P1 (mm) | W (mm) | Pin1 Quadrant |
|------------|--------------|-----------------|------|------|--------------------|--------------------|---------|---------|---------|---------|--------|---------------|
| TPS7201QDR | SOIC | D | 8 | 2500 | 330.0 | 12.4 | 6.4 | 5.2 | 2.1 | 8.0 | 12.0 | Q1 |
| TPS7225QDR | SOIC | D | 8 | 2500 | 330.0 | 12.4 | 6.4 | 5.2 | 2.1 | 8.0 | 12.0 | Q1 |
| TPS7233QDR | SOIC | D | 8 | 2500 | 330.0 | 12.4 | 6.4 | 5.2 | 2.1 | 8.0 | 12.0 | Q1 |
| TPS7250QDR | SOIC | D | 8 | 2500 | 330.0 | 12.4 | 6.4 | 5.2 | 2.1 | 8.0 | 12.0 | Q1 |

TAPE AND REEL BOX DIMENSIONS

*All dimensions are nominal

| Device | Package Type | Package Drawing | Pins | SPQ | Length (mm) | Width (mm) | Height (mm) |
|------------|--------------|-----------------|------|------|-------------|------------|-------------|
| TPS7201QDR | SOIC | D | 8 | 2500 | 367.0 | 367.0 | 35.0 |
| TPS7225QDR | SOIC | D | 8 | 2500 | 367.0 | 367.0 | 35.0 |
| TPS7233QDR | SOIC | D | 8 | 2500 | 367.0 | 367.0 | 35.0 |
| TPS7250QDR | SOIC | D | 8 | 2500 | 367.0 | 367.0 | 35.0 |

P (R-PDIP-T8)

PLASTIC DUAL-IN-LINE PACKAGE



- NOTES:
- A. All linear dimensions are in inches (millimeters).
 - B. This drawing is subject to change without notice.
 - C. Falls within JEDEC MS-001 variation BA.

D (R-PDSO-G8)

PLASTIC SMALL OUTLINE



NOTES: A. All linear dimensions are in inches (millimeters).
 B. This drawing is subject to change without notice.
 C. Body length does not include mold flash, protrusions, or gate burrs. Mold flash, protrusions, or gate burrs shall not exceed 0.006 (0,15) each side.
 D. Body width does not include interlead flash. Interlead flash shall not exceed 0.017 (0,43) each side.
 E. Reference JEDEC MS-012 variation AA.

D (R-PDSO-G8)

PLASTIC SMALL OUTLINE



- NOTES:
- A. All linear dimensions are in millimeters.
 - B. This drawing is subject to change without notice.
 - C. Publication IPC-7351 is recommended for alternate designs.
 - D. Laser cutting apertures with trapezoidal walls and also rounding corners will offer better paste release. Customers should contact their board assembly site for stencil design recommendations. Refer to IPC-7525 for other stencil recommendations.
 - E. Customers should contact their board fabrication site for solder mask tolerances between and around signal pads.

PW (R-PDSO-G8)

PLASTIC SMALL OUTLINE

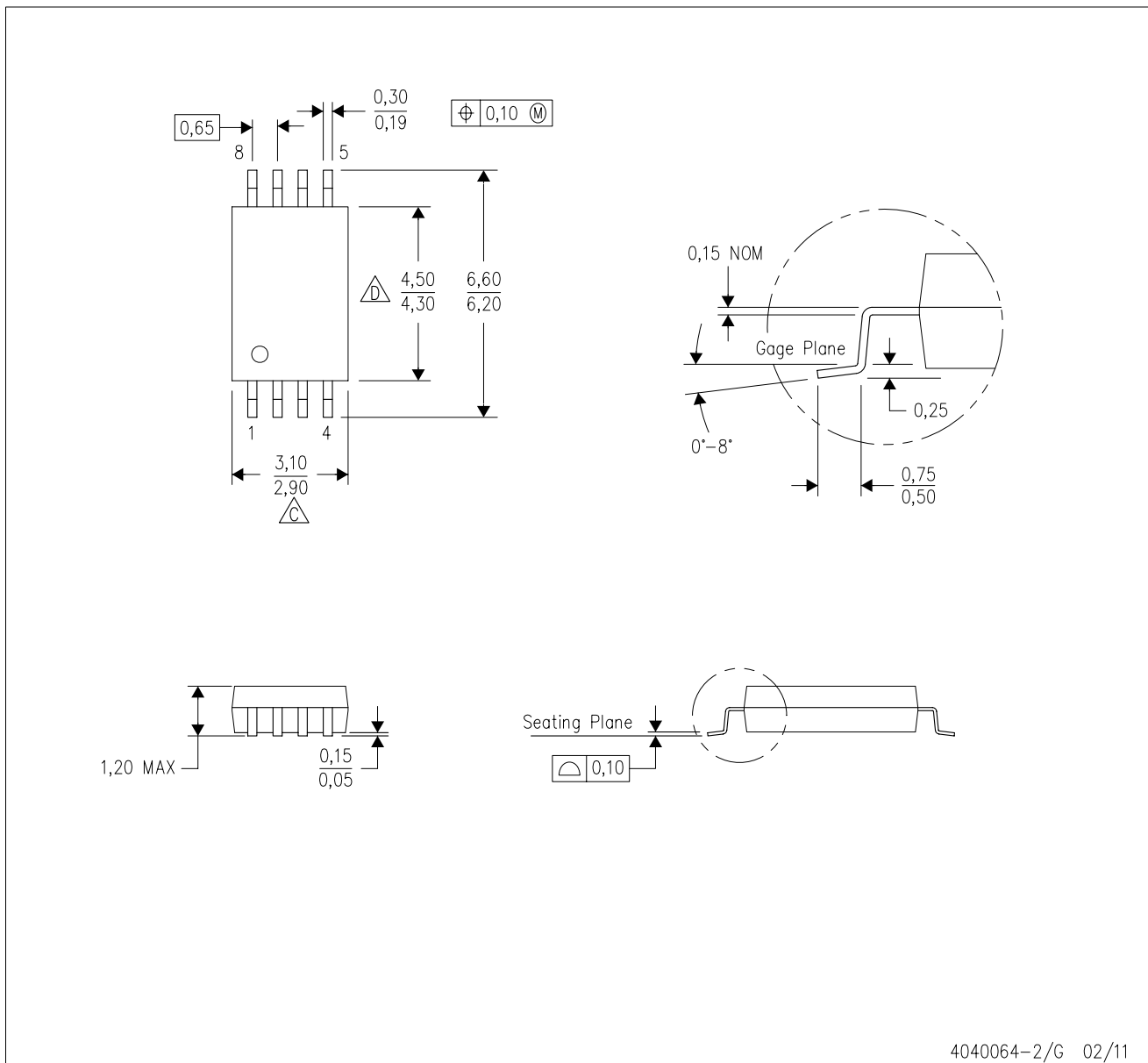

- NOTES:
- A. All linear dimensions are in millimeters. Dimensioning and tolerancing per ASME Y14.5M-1994.
 - B. This drawing is subject to change without notice.
 - C. Body length does not include mold flash, protrusions, or gate burrs. Mold flash, protrusions, or gate burrs shall not exceed 0,15 each side.
 - D. Body width does not include interlead flash. Interlead flash shall not exceed 0,25 each side.
 - E. Falls within JEDEC MO-153

IMPORTANT NOTICE

Texas Instruments Incorporated and its subsidiaries (TI) reserve the right to make corrections, enhancements, improvements and other changes to its semiconductor products and services per JESD46, latest issue, and to discontinue any product or service per JESD48, latest issue. Buyers should obtain the latest relevant information before placing orders and should verify that such information is current and complete. All semiconductor products (also referred to herein as "components") are sold subject to TI's terms and conditions of sale supplied at the time of order acknowledgment.

TI warrants performance of its components to the specifications applicable at the time of sale, in accordance with the warranty in TI's terms and conditions of sale of semiconductor products. Testing and other quality control techniques are used to the extent TI deems necessary to support this warranty. Except where mandated by applicable law, testing of all parameters of each component is not necessarily performed.

TI assumes no liability for applications assistance or the design of Buyers' products. Buyers are responsible for their products and applications using TI components. To minimize the risks associated with Buyers' products and applications, Buyers should provide adequate design and operating safeguards.

TI does not warrant or represent that any license, either express or implied, is granted under any patent right, copyright, mask work right, or other intellectual property right relating to any combination, machine, or process in which TI components or services are used. Information published by TI regarding third-party products or services does not constitute a license to use such products or services or a warranty or endorsement thereof. Use of such information may require a license from a third party under the patents or other intellectual property of the third party, or a license from TI under the patents or other intellectual property of TI.

Reproduction of significant portions of TI information in TI data books or data sheets is permissible only if reproduction is without alteration and is accompanied by all associated warranties, conditions, limitations, and notices. TI is not responsible or liable for such altered documentation. Information of third parties may be subject to additional restrictions.

Resale of TI components or services with statements different from or beyond the parameters stated by TI for that component or service voids all express and any implied warranties for the associated TI component or service and is an unfair and deceptive business practice. TI is not responsible or liable for any such statements.

Buyer acknowledges and agrees that it is solely responsible for compliance with all legal, regulatory and safety-related requirements concerning its products, and any use of TI components in its applications, notwithstanding any applications-related information or support that may be provided by TI. Buyer represents and agrees that it has all the necessary expertise to create and implement safeguards which anticipate dangerous consequences of failures, monitor failures and their consequences, lessen the likelihood of failures that might cause harm and take appropriate remedial actions. Buyer will fully indemnify TI and its representatives against any damages arising out of the use of any TI components in safety-critical applications.

In some cases, TI components may be promoted specifically to facilitate safety-related applications. With such components, TI's goal is to help enable customers to design and create their own end-product solutions that meet applicable functional safety standards and requirements. Nonetheless, such components are subject to these terms.

No TI components are authorized for use in FDA Class III (or similar life-critical medical equipment) unless authorized officers of the parties have executed a special agreement specifically governing such use.

Only those TI components which TI has specifically designated as military grade or "enhanced plastic" are designed and intended for use in military/aerospace applications or environments. Buyer acknowledges and agrees that any military or aerospace use of TI components which have **not** been so designated is solely at the Buyer's risk, and that Buyer is solely responsible for compliance with all legal and regulatory requirements in connection with such use.

TI has specifically designated certain components as meeting ISO/TS16949 requirements, mainly for automotive use. In any case of use of non-designated products, TI will not be responsible for any failure to meet ISO/TS16949.

Products

| | |
|------------------------------|--|
| Audio | www.ti.com/audio |
| Amplifiers | amplifier.ti.com |
| Data Converters | dataconverter.ti.com |
| DLP® Products | www.dlp.com |
| DSP | dsp.ti.com |
| Clocks and Timers | www.ti.com/clocks |
| Interface | interface.ti.com |
| Logic | logic.ti.com |
| Power Mgmt | power.ti.com |
| Microcontrollers | microcontroller.ti.com |
| RFID | www.ti-rfid.com |
| OMAP Applications Processors | www.ti.com/omap |
| Wireless Connectivity | www.ti.com/wirelessconnectivity |

Applications

| | |
|-------------------------------|--|
| Automotive and Transportation | www.ti.com/automotive |
| Communications and Telecom | www.ti.com/communications |
| Computers and Peripherals | www.ti.com/computers |
| Consumer Electronics | www.ti.com/consumer-apps |
| Energy and Lighting | www.ti.com/energy |
| Industrial | www.ti.com/industrial |
| Medical | www.ti.com/medical |
| Security | www.ti.com/security |
| Space, Avionics and Defense | www.ti.com/space-avionics-defense |
| Video and Imaging | www.ti.com/video |

TI E2E Community

e2e.ti.com

Mouser Electronics

Authorized Distributor

Click to View Pricing, Inventory, Delivery & Lifecycle Information:

[Texas Instruments:](#)

[TPS7233QD](#) [TPS7233QDG4](#) [TPS7233QDR](#) [TPS7233QDRG4](#) [TPS7233QP](#) [TPS7233QPE4](#) [TPS7233QPWR](#)