

## PCB Connector Series

KLS1-4.20 Pitch=4.20mm TYPE

### Electrical Specification:

Rated Voltage: 300V AC/DC  
 Rated Current: 9A  
 Contact Resistance: 0.015Ω max  
 Insulation Resistance: 1000MΩ min  
 Withstand voltage: 1500V AC/MIN  
 Temperature range for usage : -40°C~+105°C

### Material:

Housing: PA66 (PA66) UL94V-2  
 Contacts: Phosphor Bronze  
 Plating: Tin 50u" over 100u" nickel  
 Wire range : AWG#30~#22

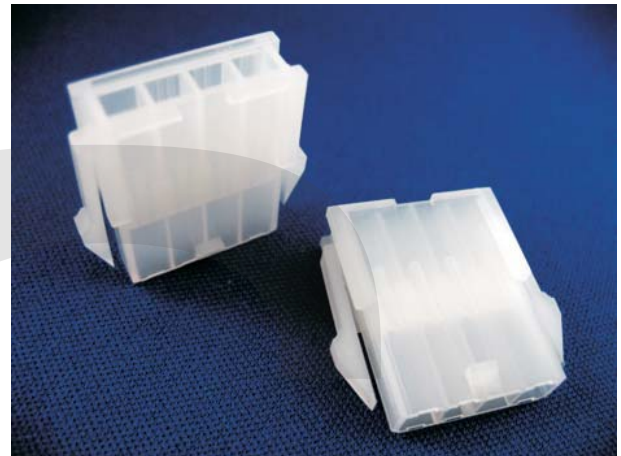

### Single layer Female Housing

PART NO.	Dimensions	
	A	B
02	4.20	9.60
03	8.40	13.80
04	12.60	18.00
05	16.80	22.20

mate with terminl p/n: KLS1-4.20-MT

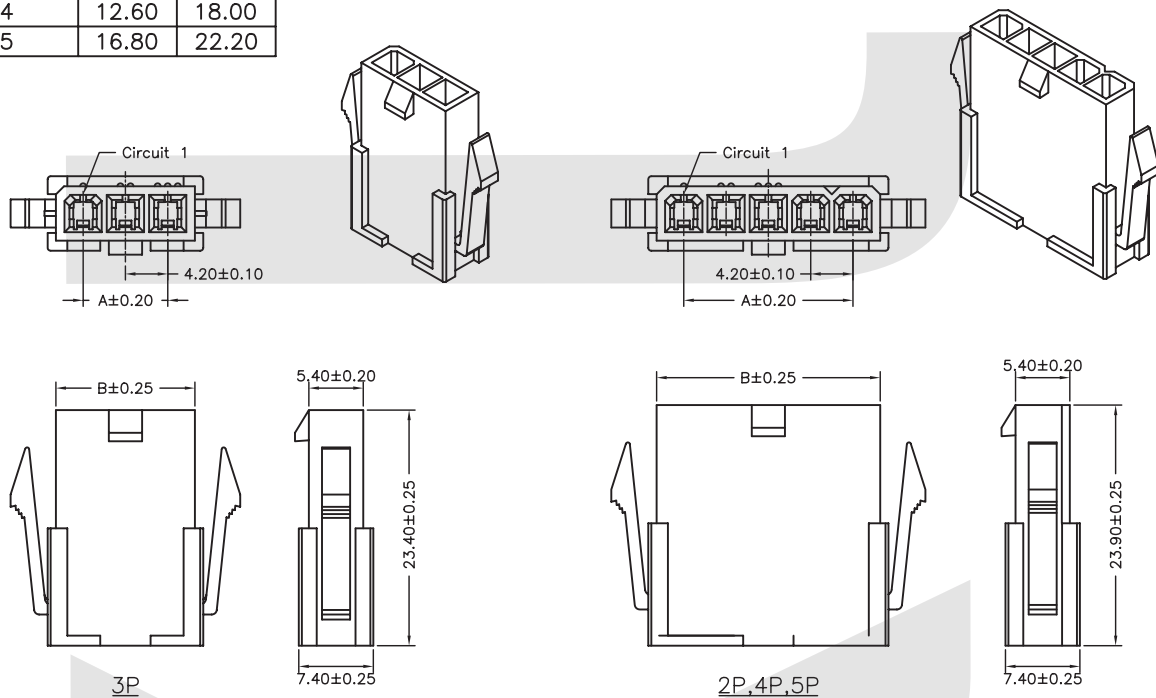

## ORDER INFORMATION

Product NO.: KLS1-4.20 -1X05-FH

Pitch: 4.20=4.20mm  
 Pins: 1-Single layer  
 Pin Number: 2~12Pin

2-Double layer

Type: MH=Male Housing FT=Female Terminal  
 FH=Female Housing MT=Male Terminal  
 S=Straight pin R=Right pin  
 SW=Straight pin with Peg RW=Right pin with Peg  
 SB=Straight pin Special Type RB=Right pin with Ears

## PCB Connector Series

KLS1-4.20 Pitch=4.20mm TYPE

### Electrical Specification:

Rated Voltage: 300V AC/DC  
 Rated Current: 9A  
 Contact Resistance: 0.015Ω max  
 Insulation Resistance: 1000MΩ min  
 Withstand voltage: 1500V AC/MIN  
 Temperature range for usage : -40°C~+105°C

### Material:

Housing: PA66 (PA66) UL94V-2  
 Contacts: Phosphor Bronze  
 Plating: Tin 50u" over 100u" nickel  
 Wire range : AWG#30~#22

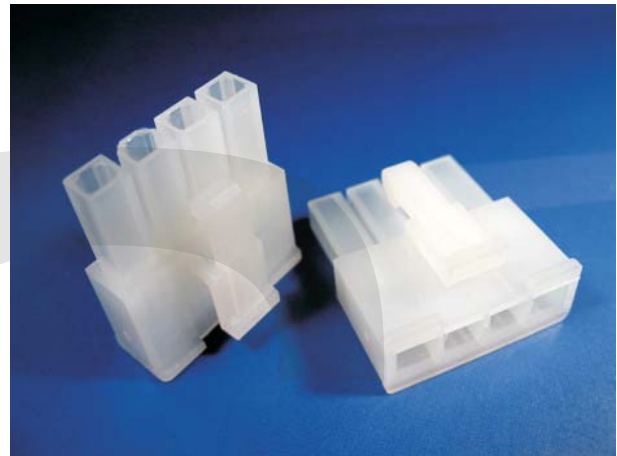

### Single layer Male Housing

PART NO.	Dimensions	
	A	B
02	4.20	9.60
03	8.40	13.80
04	12.60	18.00
05	16.80	22.20



mate with terminl p/n: KLS1-4.20-FT

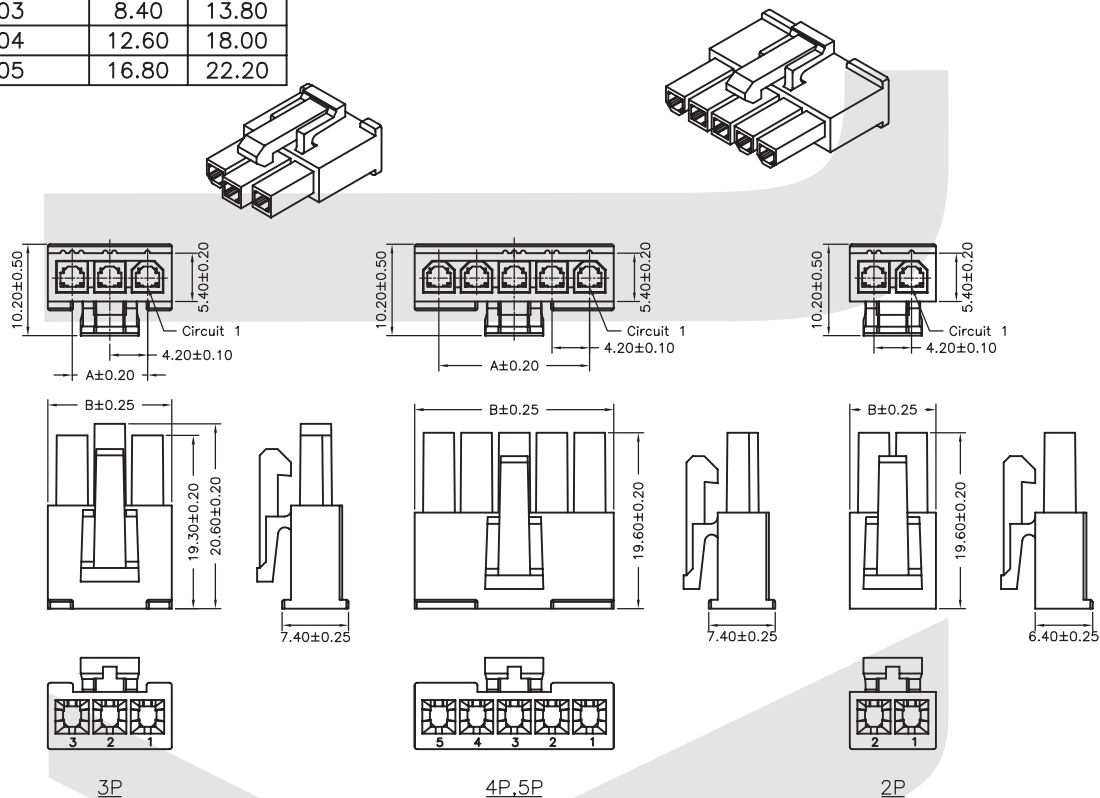

## ORDER INFORMATION

Product NO.: KLS1-4.20 -1X05- MH

Pitch: 4.20=4.20mm  
 Pins: 1-Single layer  
 Pin Number: 2~12Pin

2-Double layer

Type: MH=Male Housing      FT=Female Terminal  
 FH=Female Housing      MT=Male Terminal  
 S=Straight pin              R=Right pin  
 SW=Straight pin with Peg      RW=Right pin with Peg  
 SB=Straight pin Special Type      RB=Right pin with Ears

## PCB Connector Series

KLS1-4.20 Pitch=4.20mm TYPE

### Electrical Specification:

Rated Voltage: 300V AC/DC  
 Rated Current: 9A  
 Contact Resistance: 0.015Ω max  
 Insulation Resistance: 1000MΩ min  
 Withstand voltage: 1500V AC/MIN  
 Temperature range for usage : -40°C~+105°C

### Material:

Housing: PA66 (PA66) UL94V-2  
 Contacts: Phosphor Bronze  
 Plating: Tin 50u" over 100u" nickel  
 Wire range : AWG#30~#22

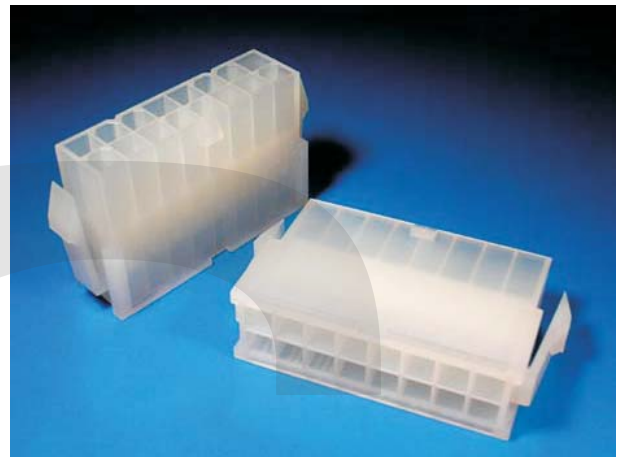

### Double layer Female Housing

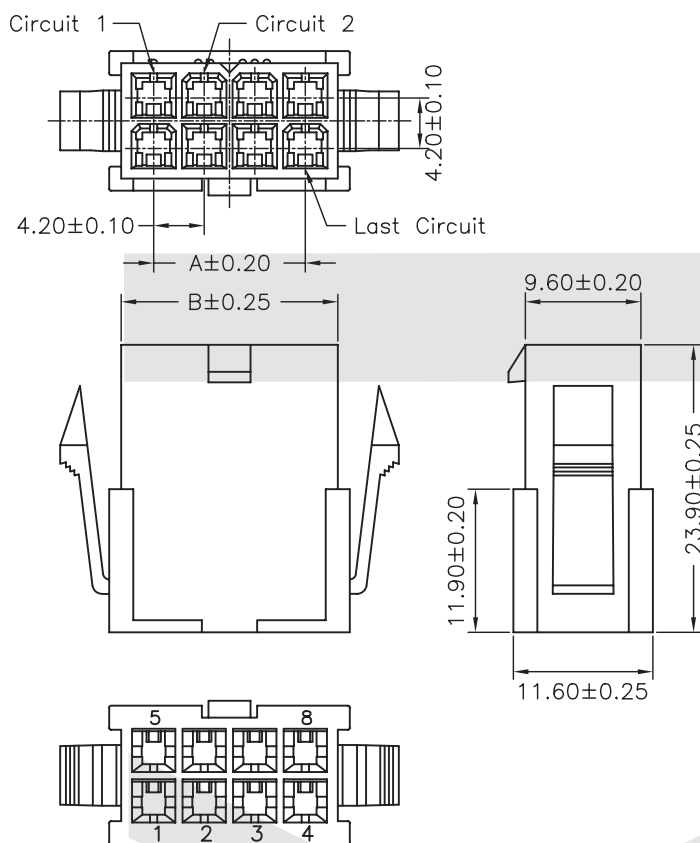

mate with terminl p/n: KLS1-4.20-MT

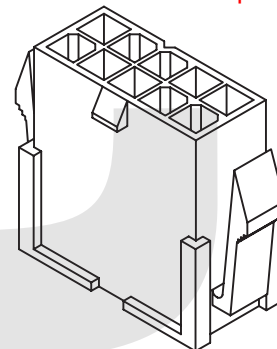

PART NO.	Dimensions	
	A	B
2X01	---	5.40
2X02	4.20	9.60
2X03	8.40	13.80
2X04	12.60	18.00
2X05	16.80	22.20
2X06	21.00	26.40
2X07	25.20	30.60
2X08	29.40	34.80
2X09	33.60	39.00
2X10	37.80	43.20
2X11	42.00	47.40
2X12	46.20	51.60

## ORDER INFORMATION

Product NO.: KLS1-4.20 -2X05-FH

Pitch: 4.20=4.20mm  
 Pins: 1-Single layer  
 Pin Number: 2~12Pin

2-Double layer

Type: MH=Male Housing      FT=Female Terminal  
 FH=Female Housing      MT=Male Terminal  
 S=Straight pin              R=Right pin  
 SW=Straight pin with Peg      RW=Right pin with Peg  
 SB=Straight pin Special Type      RB=Right pin with Ears

**PCB Connector Series**

KLS1-4.20 Pitch=4.20mm TYPE

**Electrical Specification:**

- Rated Voltage: 300V AC/DC
- Rated Current: 9A
- Contact Resistance: 0.015Ω max
- Insulation Resistance: 1000MΩ min
- Withstand voltage: 1500V AC/MIN
- Temperature range for usage : -40°C~+105°C

**Material:**

- Housing: PA66 (PA66) UL94V-2
- Contacts: Phosphor Bronze
- Plating: Tin 50u" over 100u" nickel
- Wire range : AWG#30~#22

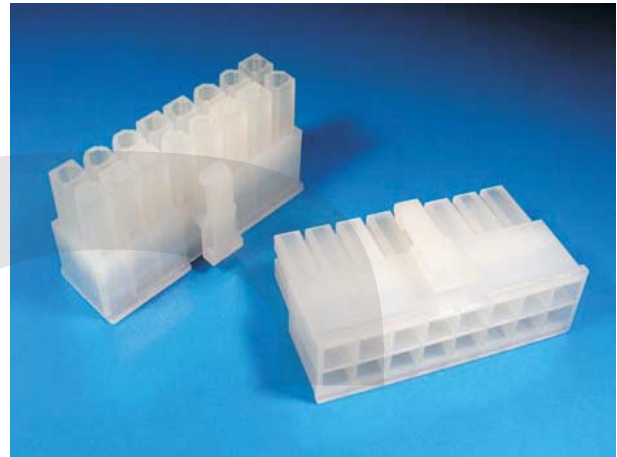

**Double layer Male Housing**

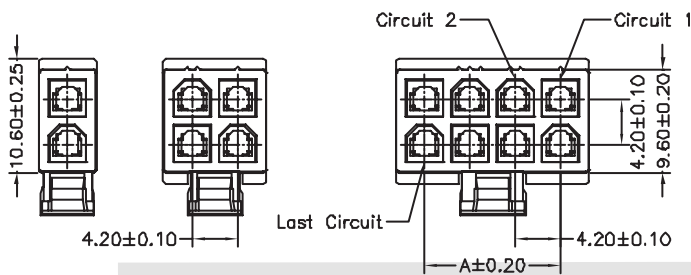

mate with terminl p/n: KLS1-4.20-FT

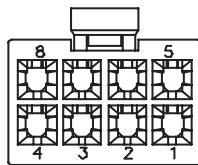
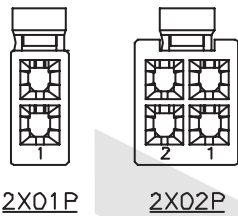
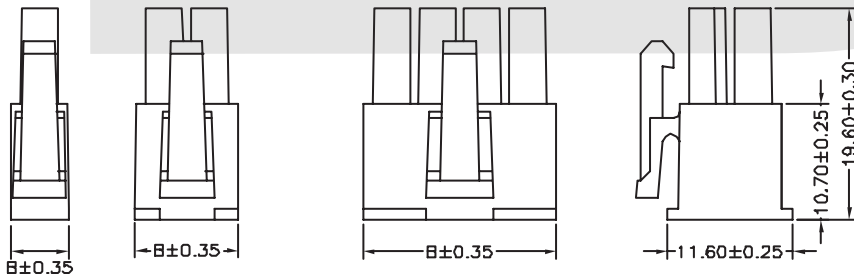
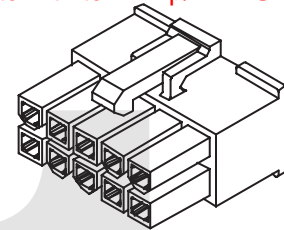

PART NO.	Dimensions	
	A	B
2X01	---	5.70
2X02	4.20	9.60
2X03	8.40	13.80
2X04	12.60	18.00
2X05	16.80	22.20
2X06	21.00	26.40
2X07	25.20	30.60
2X08	29.40	34.80
2X09	33.60	39.00
2X10	37.80	43.20
2X11	42.00	47.40
2X12	46.20	51.60

**ORDER INFORMATION**

Product NO.: KLS1-4.20 -2X05- MH

- Pitch: 4.20=4.20mm
- Pins: 1-Single layer 2-Double layer
- Pin Number: 2~12Pin
- Type: MH=Male Housing FT=Female Terminal
- FH=Female Housing MT=Male Terminal
- S=Straight pin R=Right pin
- SW=Straight pin with Peg RW=Right pin with Peg
- SB=Straight pin Special Type RB=Right pin with Ears

## PCB Connector Series

KLS1-4.20 Pitch=4.20mm TYPE

### Electrical Specification:

Rated Voltage: 300V AC/DC  
 Rated Current: 9A  
 Contact Resistance: 0.015Ω max  
 Insulation Resistance: 1000MΩ min  
 Withstand voltage: 1500V AC/MIN  
 Temperature range for usage : -40°C~+105°C

### Material:

Housing: PA66 (PA66) UL94V-2  
 Contacts: Brass  
 Plating: Tin 50u" over 100u" nickel  
 Wire range : AWG#30~#22

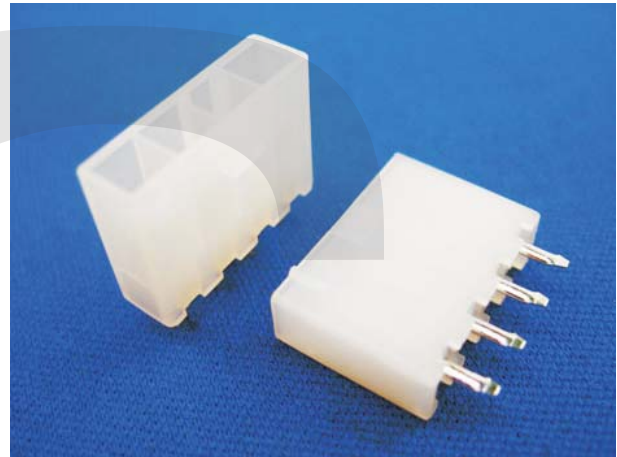

### Single layer Straight pin

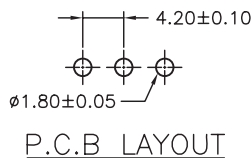
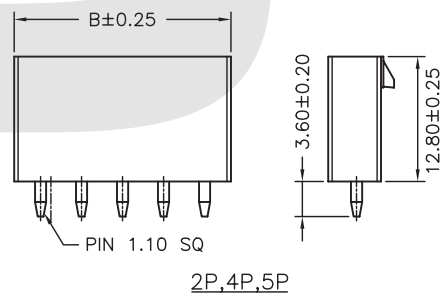
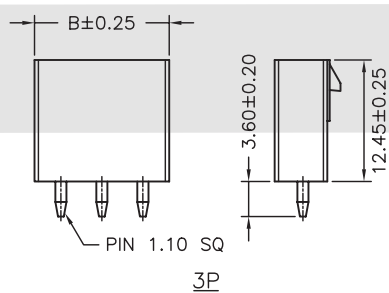
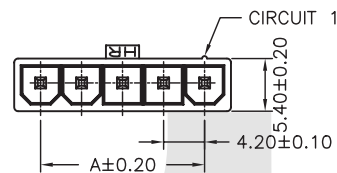
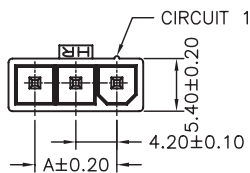

PART NO.	Dimensions	
	A	B
02	4.20	9.60
03	8.40	13.80
04	12.60	18.00
05	16.80	22.20

## ORDER INFORMATION

Product NO.: KLS1-4.20 -1X05- S

Pitch: 4.20=4.20mm  
 Pins: 1-Single layer  
 Pin Number: 2~12Pin

2-Double layer

Type: MH=Male Housing    FT=Female Terminal  
 FH=Female Housing    MT=Male Terminal  
 S=Straight pin    R=Right pin  
 SW=Straight pin with Peg    RW=Right pin with Peg  
 SB=Straight pin Special Type    RB=Right pin with Ears

## PCB Connector Series

KLS1-4.20 Pitch=4.20mm TYPE

### Electrical Specification:

Rated Voltage: 300V AC/DC  
 Rated Current: 9A  
 Contact Resistance: 0.015Ω max  
 Insulation Resistance: 1000MΩ min  
 Withstand voltage: 1500V AC/MIN  
 Temperature range for usage : -40°C~+105°C

### Material:

Housing: PA66 (PA66) UL94V-2  
 Contacts: Brass  
 Plating: Tin 50u" over 100u" nickel  
 Wire range : AWG#30~#22

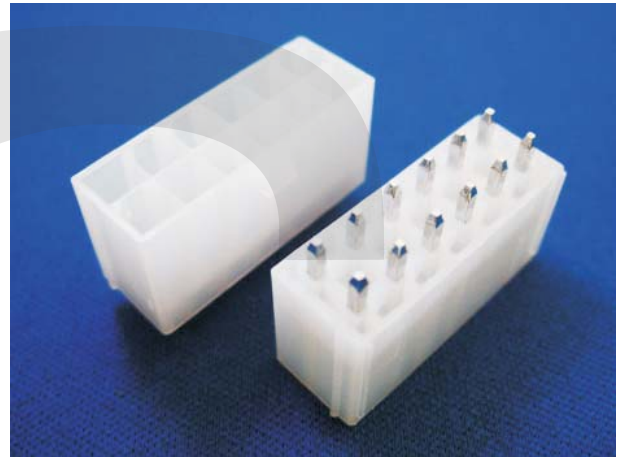

### Double layer Straight pin

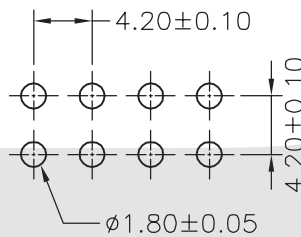
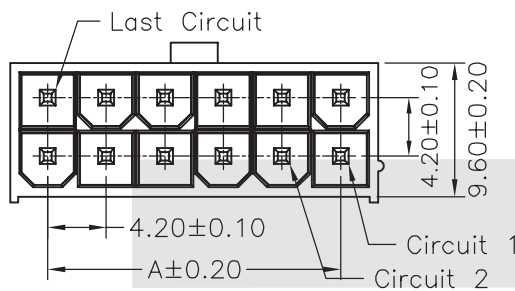

P.C.B LAYOUT

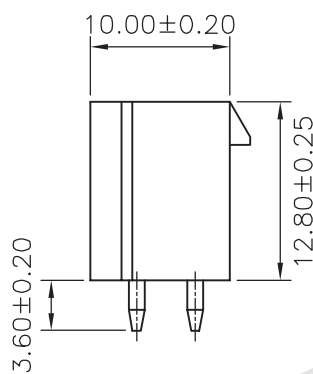
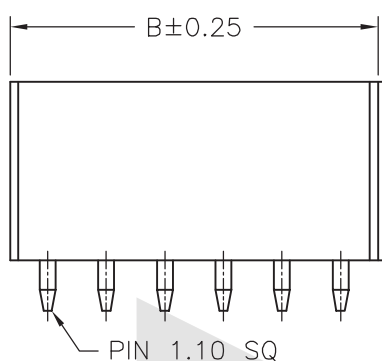
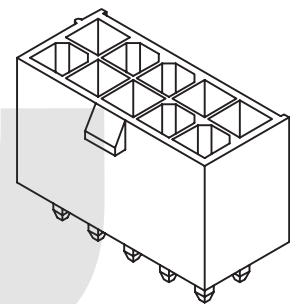

PART NO.	Dimensions	
	A	B
2X01	---	5.40
2X02	4.20	9.60
2X03	8.40	13.80
2X04	12.60	18.00
2X05	16.80	22.20
2X06	21.00	26.40
2X07	25.20	30.60
2X08	29.40	34.80
2X09	33.60	39.00
2X10	37.80	43.20
2X11	42.00	47.40
2X12	46.20	51.60

## ORDER INFORMATION

Product NO.: KLS1-4.20 -2X05- S

Pitch: 4.20=4.20mm  
 Pins: 1-Single layer  
 Pin Number: 2~12Pin

2-Double layer

Type: MH=Male Housing FT=Female Terminal  
 FH=Female Housing MT=Male Terminal  
 S=Straight pin R=Right pin  
 SW=Straight pin with Peg RW=Right pin with Peg  
 SB=Straight pin Special Type RB=Right pin with Ears

## PCB Connector Series

KLS1-4.20 Pitch=4.20mm TYPE

### Electrical Specification:

Rated Voltage: 300V AC.DC  
 Rated Current: 9A  
 Contact Resistance: 0.015Ω max  
 Insulation Resistance: 1000MΩ min  
 Withstand voltage: 1500V AC/MIN  
 Temperature range for usage : -40°C~+105°C

### Material:

Housing: PA66 (PA66) UL94V-2  
 Contacts: Brass  
 Plating: Tin 50u" over 100u" nickel  
 Wire range : AWG#30~#22

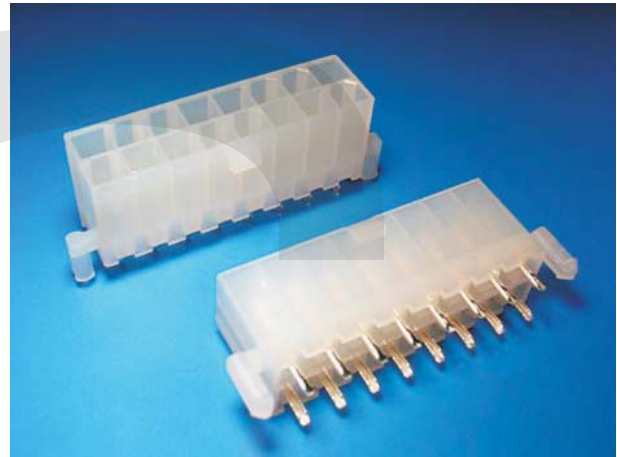

### Double layer Straight pin With Peg

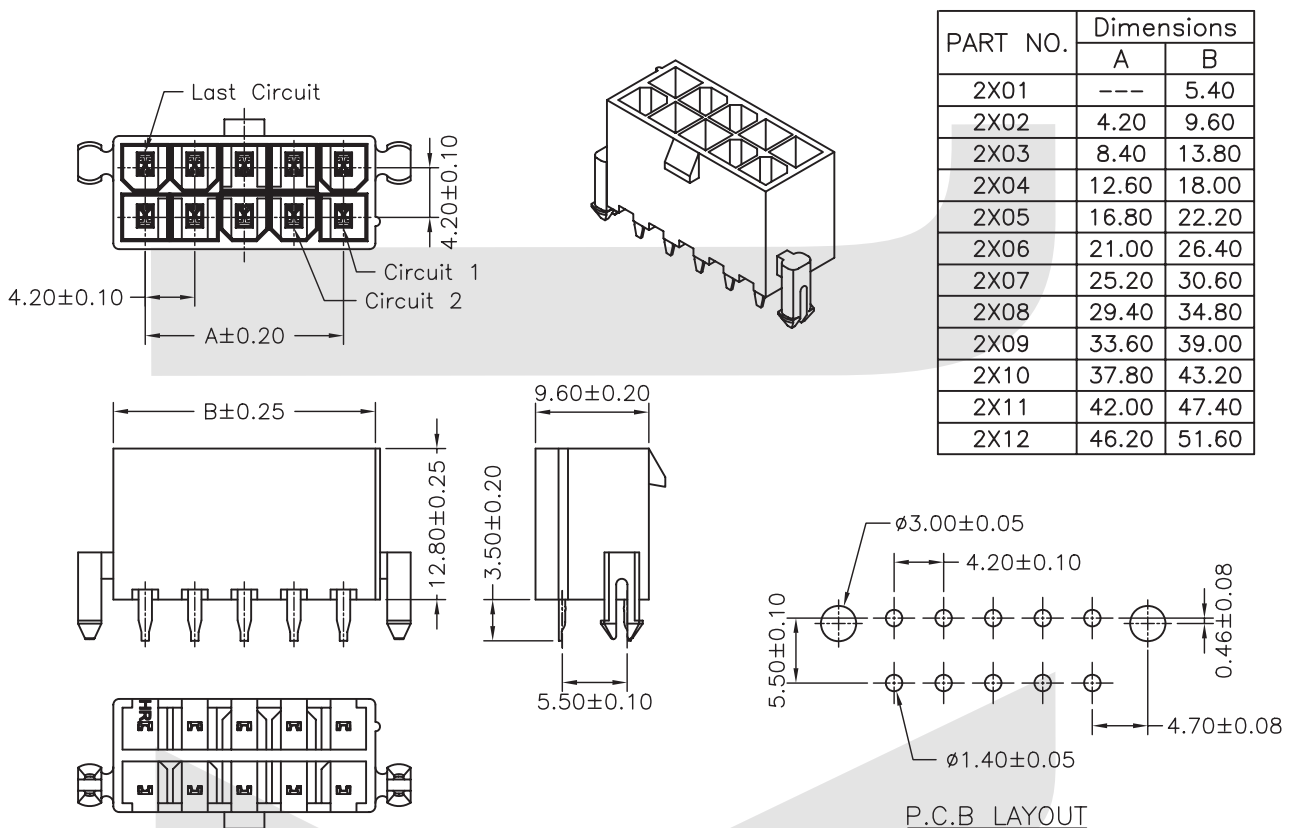

## ORDER INFORMATION

Product NO.: KLS1-4.20 -2X05-SW

Pitch: 4.20=4.20mm  
 Pins: 1-Single layer 2-Double layer  
 Pin Number: 2~12Pin

Type:MH=Male Housing FT=Female Terminal  
 FH=Female Housing MT=Male Terminal  
 S=Straight pin R=Right pin  
 SW=Straight pin with Peg RW=Right pin with Peg  
 SB=Straight pin Special Type RB=Right pin with Ears

## PCB Connector Series

KLS1-4.20 Pitch=4.20mm TYPE

### Electrical Specification:

Rated Voltage: 300V AC/DC  
 Rated Current: 9A  
 Contact Resistance: 0.015Ω max  
 Insulation Resistance: 1000MΩ min  
 Withstand voltage: 1500V AC/MIN  
 Temperature range for usage : -40°C~+105°C

### Material:

Housing: PA66 (PA66) UL94V-2  
 Contacts: Brass  
 Plating: Tin 50u" over 100u" nickel  
 Wire range : AWG#30~#22

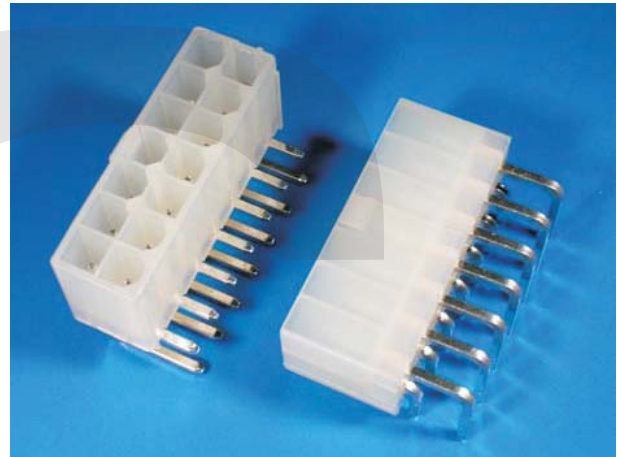

### Double layer Right pin

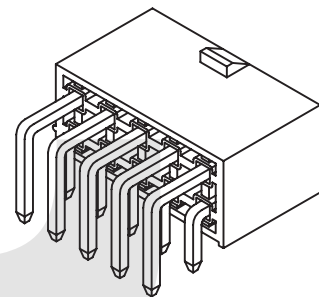
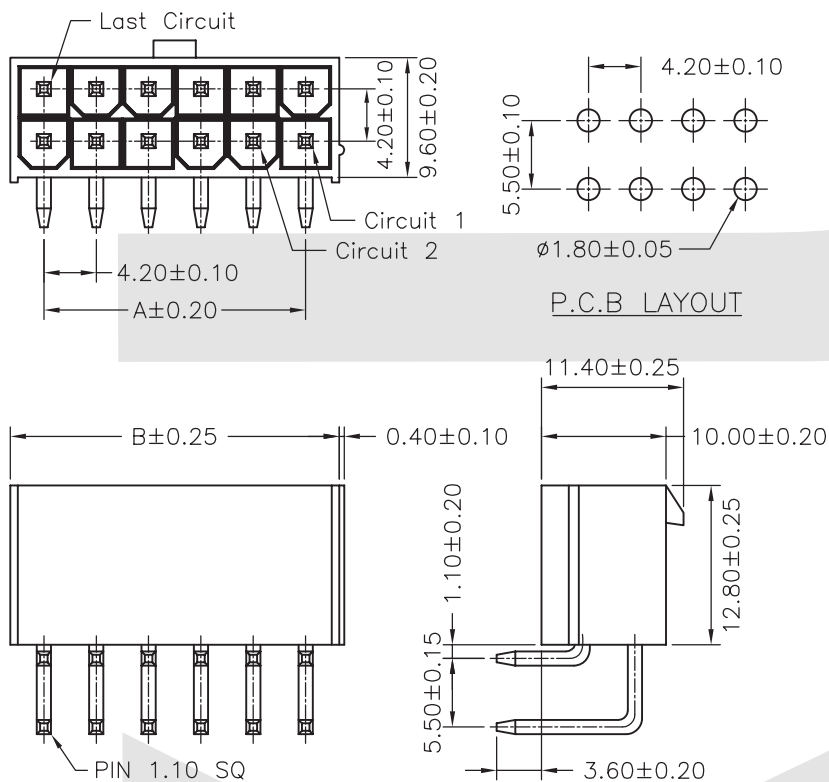

PART NO.	Dimensions	
	A	B
2X01	---	5.40
2X02	4.20	9.60
2X03	8.40	13.80
2X04	12.60	18.00
2X05	16.80	22.20
2X06	21.00	26.40
2X07	25.20	30.60
2X08	29.40	34.80
2X09	33.60	39.00
2X10	37.80	43.20
2X11	42.00	47.40
2X12	46.20	51.60

## ORDER INFORMATION

Product NO.: KLS1-4.20 -2X05- R

Pitch: 4.20=4.20mm  
 Pins: 1-Single layer  
 Pin Number: 2~12Pin

2-Double layer

Type: MH=Male Housing      FT=Female Terminal  
 FH=Female Housing      MT=Male Terminal  
 S=Straight pin              R=Right pin  
 SW=Straight pin with Peg      RW=Right pin with Peg  
 SB=Straight pin Special Type      RB=Right pin with Ears



## PCB Connector Series

KLS1-4.20 Pitch=4.20mm TYPE

### Electrical Specification:

Rated Voltage: 300V AC.DC  
 Rated Current: 9A  
 Contact Resistance: 0.015Ω max  
 Insulation Resistance: 1000MΩ min  
 Withstand voltage: 1500V AC/MIN  
 Temperature range for usage : -40°C~+105°C

### Material:

Housing: PA66 (PA66) UL94V-2  
 Contacts: Brass  
 Plating: Tin 50u" over 100u" nickel  
 Wire range : AWG#30~#22

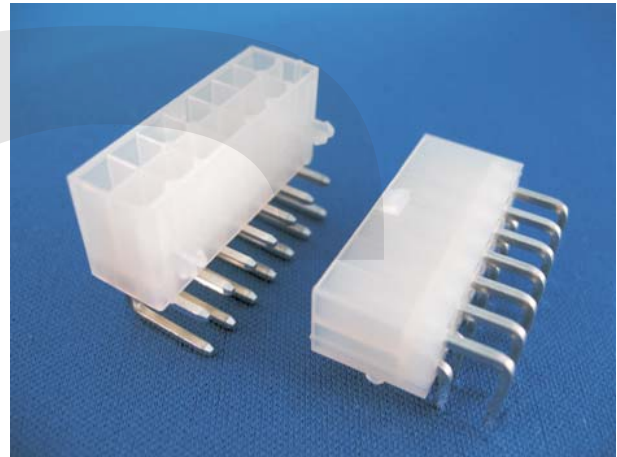

### Double layer Right pin With Peg

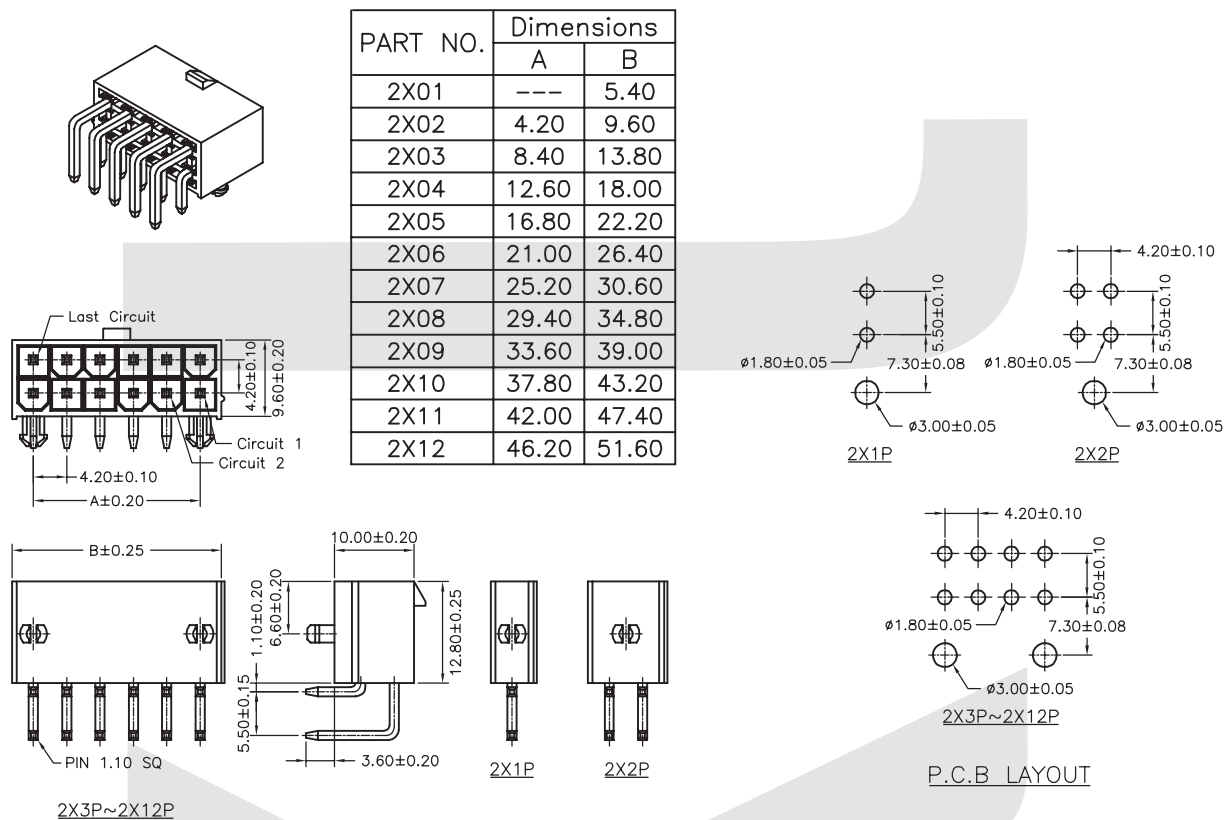

## ORDER INFORMATION

Product NO.: KLS1-4.20 -2X05-RW

Pitch: 4.20=4.20mm  
 Pins: 1-Single layer 2-Double layer  
 Pin Number: 2~12Pin

Type: MH=Male Housing FH=Female Housing S=Straight pin SW=Straight pin with Peg SB=Straight pin Special Type  
 FT=Female Terminal MT=Male Terminal R=Right pin RW=Right pin with Peg RB=Right pin with Ears

## PCB Connector Series

KLS1-4.20 Pitch=4.20mm TYPE

### Electrical Specification:

Rated Voltage: 300V AC/DC  
 Rated Current: 9A  
 Contact Resistance: 0.015Ω max  
 Insulation Resistance: 1000MΩ min  
 Withstand voltage: 1500V AC/MIN  
 Temperature range for usage : -40°C~+105°C

### Material:

Housing: PA66 (PA66) UL94V-2  
 Contacts: Brass  
 Plating: Tin 50u" over 100u" nickel  
 Wire range : AWG#30~#22

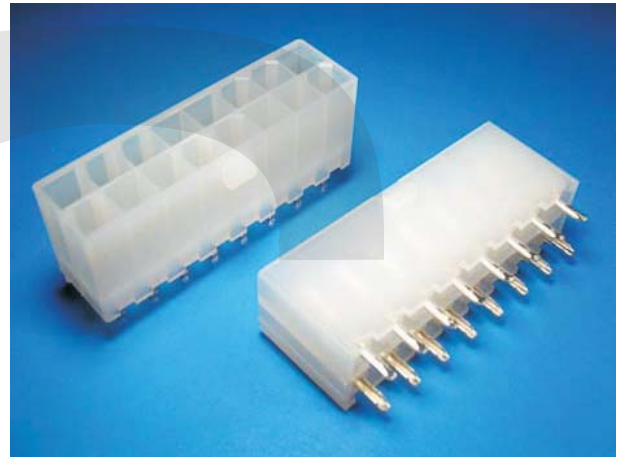

### Double layer Straight pin

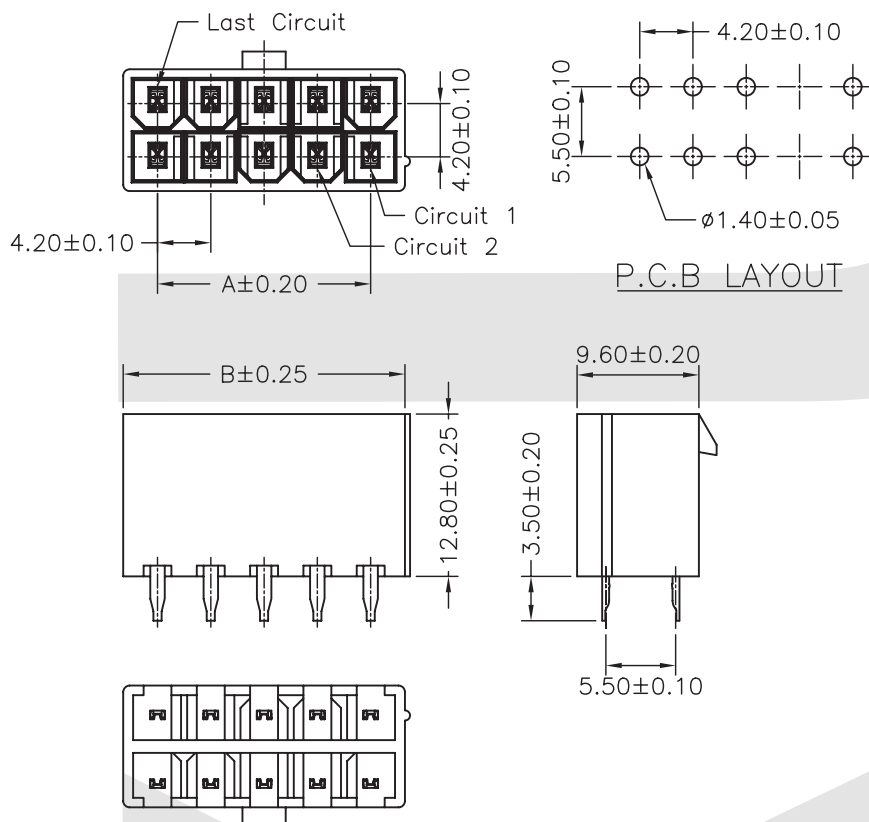

PART NO.	Dimensions	
	A	B
2X01	---	5.40
2X02	4.20	9.60
2X03	8.40	13.80
2X04	12.60	18.00
2X05	16.80	22.20
2X06	21.00	26.40
2X07	25.20	30.60
2X08	29.40	34.80
2X09	33.60	39.00
2X10	37.80	43.20
2X11	42.00	47.40
2X12	46.20	51.60

## ORDER INFORMATION

Product NO.: KLS1-4.20 -2X05-SB

Pitch: 4.20=4.20mm  
 Pins: 1-Single layer  
 Pin Number: 2~12Pin

2-Double layer

Type: MH=Male Housing      FT=Female Terminal  
 FH=Female Housing      MT=Male Terminal  
 S=Straight pin              R=Right pin  
 SW=Straight pin with Peg      RW=Right pin with Peg  
 SB=Straight pin Special Type      RB=Right pin with Ears

**PCB Connector Series**

KLS1-4.20 Pitch=4.20mm TYPE

**Electrical Specification:**

- Rated Voltage: 300V AC/DC
- Rated Current: 9A
- Contact Resistance: 0.015Ω max
- Insulation Resistance: 1000MΩ min
- Withstand voltage: 1500V AC/MIN
- Temperature range for usage : -40°C~+105°C

**Material:**

- Housing: PA66 (PA66) UL94V-2
- Contacts: Brass
- Plating: Tin 50u" over 100u" nickel
- Wire range : AWG#30~#22

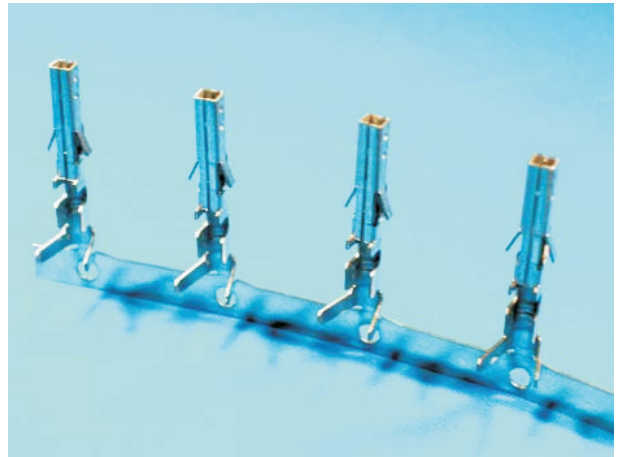

Fem ale Terminal

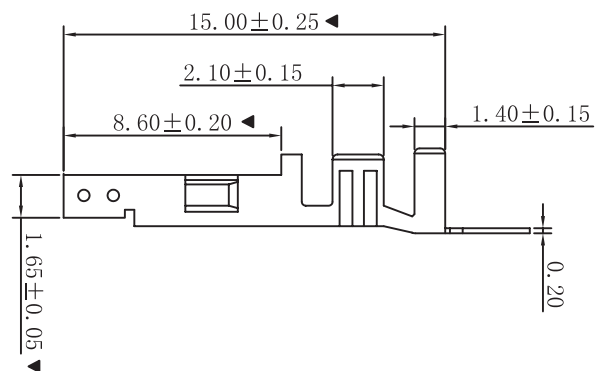
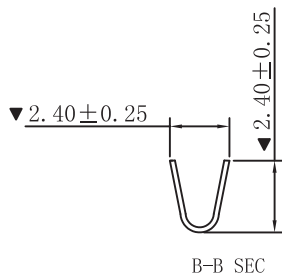
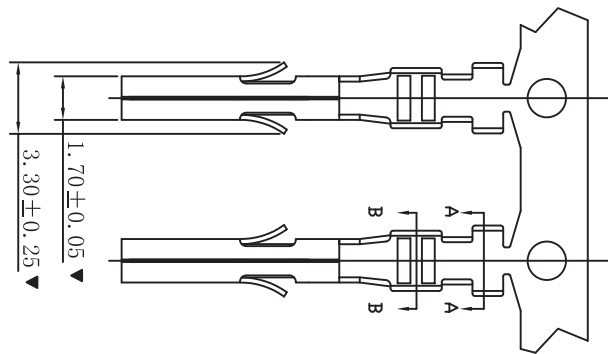
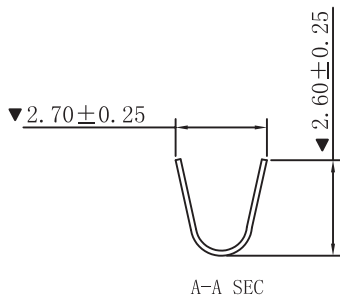

**ORDER INFORMATION**

Product NO.: KLS1-4.20 -FT

Pitch: 4.20=4.20mm

- Type: MH=Male Housing      FT=Female Terminal
- FH=Female Housing      MT=Male Terminal
- S=Straight pin      R=Right pin
- SW=Straight pin with Peg      RW=Right pin with Peg
- SB=Straight pin Special Type      RB=Right pin with Ears

## PCB Connector Series

KLS1-4.20 Pitch=4.20mm TYPE

### Electrical Specification:

Rated Voltage: 300V AC.DC  
 Rated Current: 9A  
 Contact Resistance: 0.015Ω max  
 Insulation Resistance: 1000MΩ min  
 Withstand voltage: 1500V AC/MIN  
 Temperature range for usage : -40°C~+105°C

### Material:

Housing: PA66 (PA66) UL94V-2  
 Contacts: Brass  
 Plating: Tin 50u" over 100u" nickel  
 Wire range : AWG#30~#22



### Male Terminal

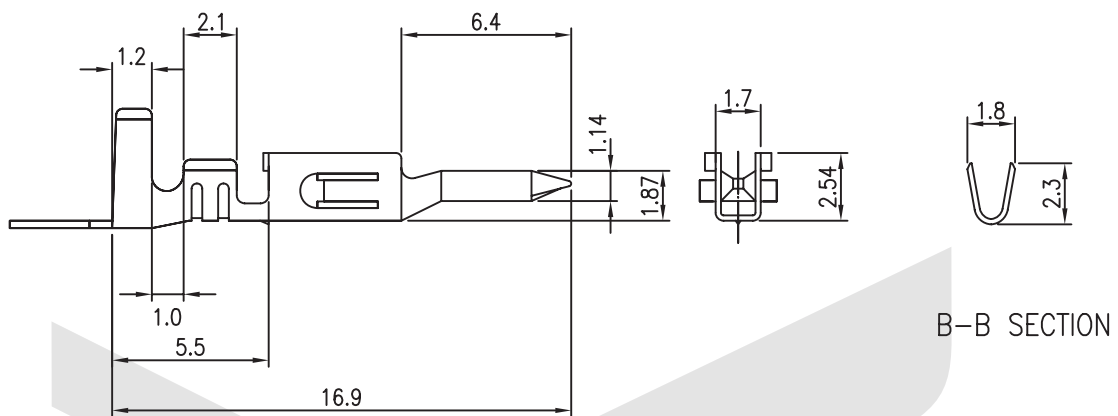
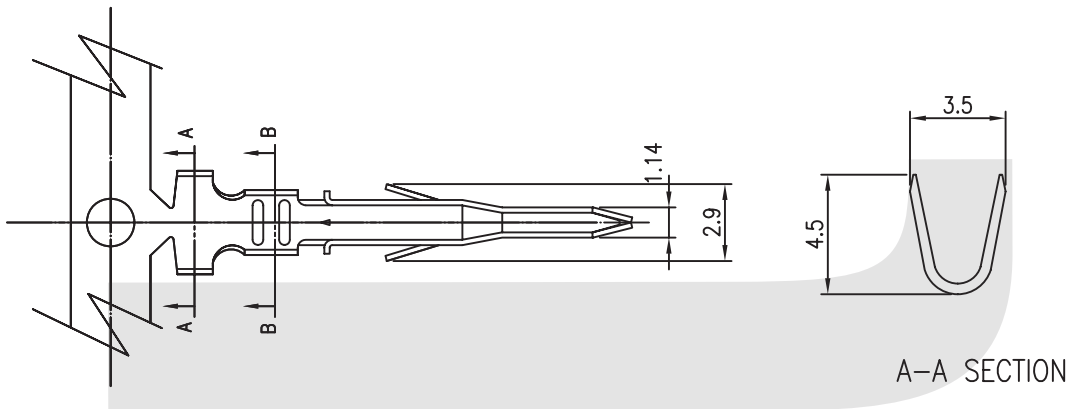

## ORDER INFORMATION

Product NO.: KLS1-4.20 -MT

Pitch: 4.20=4.20mm

Type: MH=Male Housing FT=Female Terminal  
 FH=Female Housing MT=Male Terminal  
 S=Straight pin R=Right pin  
 SW=Straight pin with Peg RW=Right pin with Peg  
 SB=Straight pin Special Type RB=Right pin with Ears

## PCB Connector Series

KLS1-4.20 Pitch=4.20mm TYPE

### Electrical Specification:

Rated Voltage: 300V AC.DC  
 Rated Current: 9A  
 Contact Resistance: 0.015Ω max  
 Insulation Resistance: 1000MΩ min  
 Withstand voltage: 1500V AC/MIN  
 Temperature range for usage: -40°C~+105°C

### Material:

Housing: PA66 (PA66) UL94V-2  
 Contacts: Brass  
 Plating: Tin 50u" over 100u" nickel  
 Wire range : AWG#30~#22

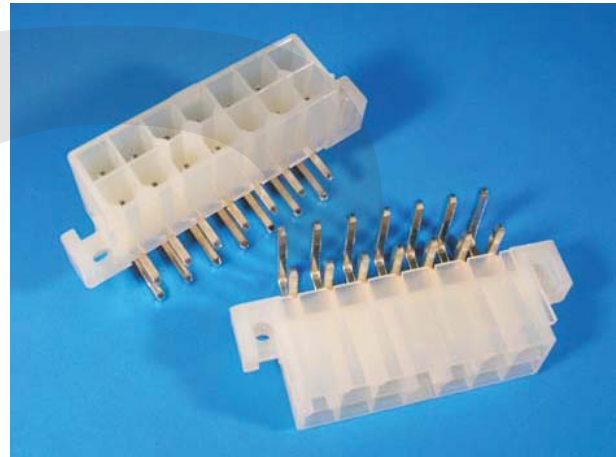

### Double layer Right pin With Peg

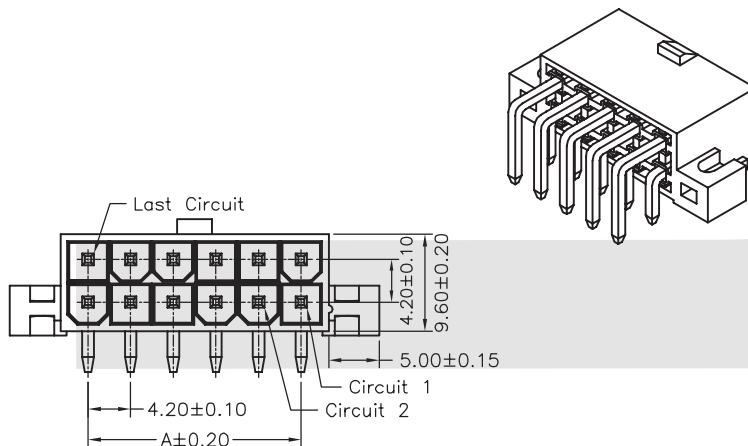

PART NO.	Dimensions	
	A	B
2X01	---	5.40
2X02	4.20	9.60
2X03	8.40	13.80
2X04	12.60	18.00
2X05	16.80	22.20
2X06	21.00	26.40
2X07	25.20	30.60
2X08	29.40	34.80
2X09	33.60	39.00
2X10	37.80	43.20
2X11	42.00	47.40
2X12	46.20	51.60

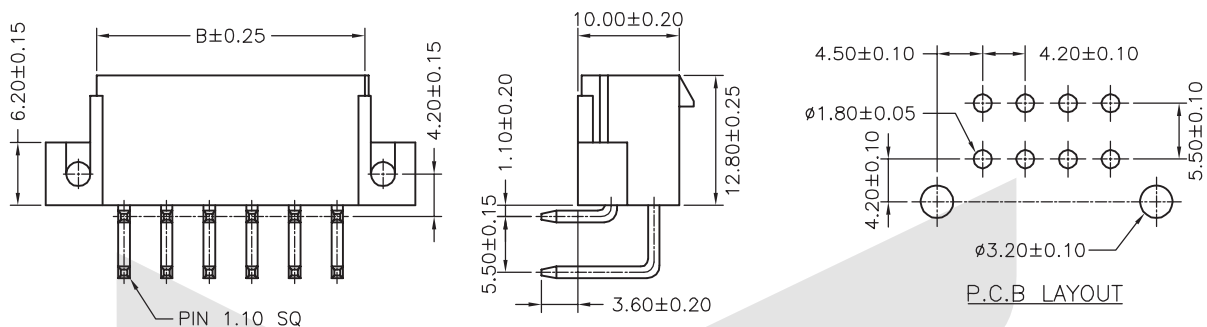

## ORDER INFORMATION

Product NO.: KLS1-4.20 -2X05-RB

Pitch: 4.20=4.20mm  
 Pins: 1-Single layer  
 Pin Number: 2~12Pin

2-Double layer

Type: MH=Male Housing    FT=Female Terminal  
 FH=Female Housing    MT=Male Terminal  
 S=Straight pin    R=Right pin  
 SW=Straight pin with Peg    RW=Right pin with Peg  
 SB=Straight pin Special Type    RB=Right pin with Ears

## PCB Connector Series

KLS1-4.20-1XN-SW

Pitch=4.20mm Type

### ■ SPECIFICATIONS

- Voltage rating: 600V AC, DC
- Current rating: 7A, AC, DC
- Withstanding Voltage: 1500V AC/minute
- Insulation resistance: 1000MΩ min
- Temperature range: -25° C ~ +85° C
- Contact resistance: 20mΩ max

### ■ WAFER

- Part No. : W4202VTTD-1xNP-XXXX
- Poles : 03-06P
- Housing Material: Nylon66 UL94V-2 or UL94V-0
- Pin Material: Brass
- Contact Area Plating: Tin-Plated or Gold-Flash
- Mates With: H4201 Single row receptacle
- The Dimension Marked “▼” Must Be Recorded

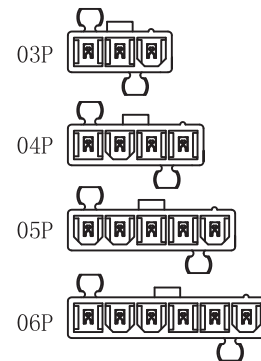
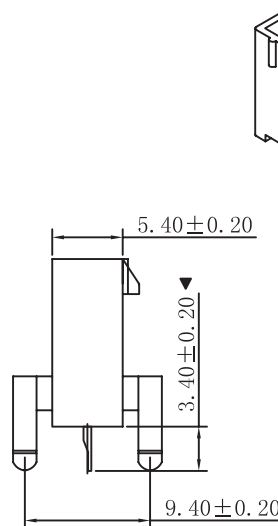
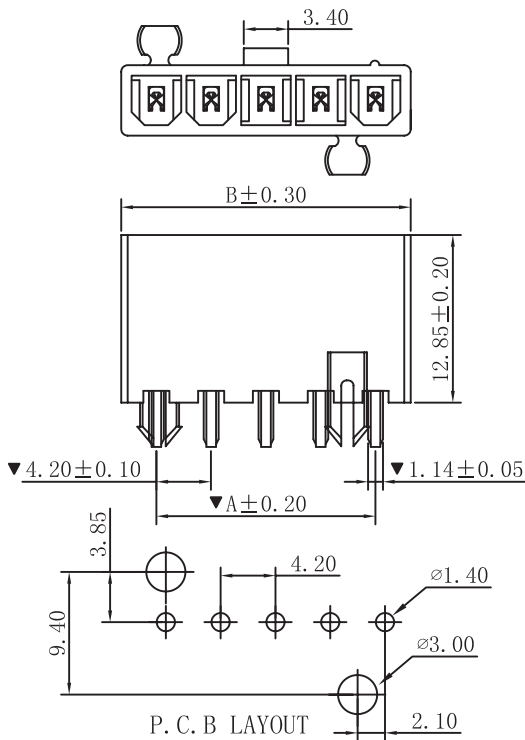
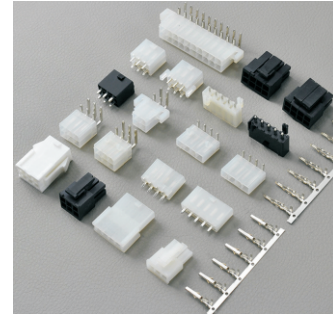

PART NO.	Dimensions (mm)	
	A	B
03	8.40	13.80
04	12.60	18.00
05	16.80	22.20
06	21.00	26.40

CIRCUIT SIZE LAYOUT

## ORDER INFORMATION

Product NO. : KLS1-4.20-1XN-SW

Pitch: 4.20mm