

CDCLVC11xx 3.3-V and 2.5-V LVCMOS High-Performance Clock Buffer Family

1 Features

- High-Performance 1:2, 1:3, 1:4, 1:6, 1:8, 1:10, 1:12 LVCMOS Clock Buffer Family
- Very Low Pin-to-Pin Skew < 50 ps
- Very Low Additive Jitter < 100 fs
- Supply Voltage: 3.3 V or 2.5 V
- $f_{max} = 250$ MHz for 3.3 V
 $f_{max} = 180$ MHz for 2.5 V
- Operating Temperature Range: -40°C to 85°C
- Available in 8-, 14-, 16-, 20-, 24-Pin TSSOP Package (All Pin Compatible)

2 Applications

- General-Purpose Communication, Industrial, and Consumer Applications

3 Description

The CDCLVC11xx is a modular, high-performance, low-skew, general-purpose clock buffer family from Texas Instruments.

The entire family is designed with a modular approach in mind. It is intended to round up TI's series of LVCMOS clock generators.

4 Functional Block Diagram

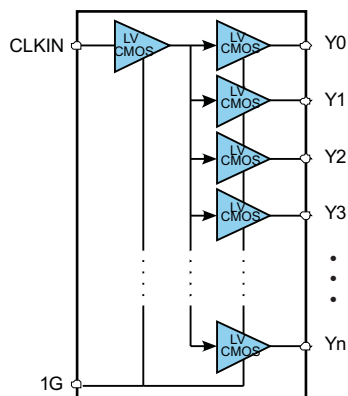

Seven different fan-out variations, 1:2 to 1:12, are available. All of the devices are pin compatible to each other for easy handling.

All family members share the same high performing characteristics such as low additive jitter, low skew, and wide operating temperature range.

The CDCLVC11xx supports an asynchronous output enable control (1G) which switches the outputs into a low state when 1G is low.

The CDCLVC11xx family operates in a 2.5-V and 3.3-V environment and are characterized for operation from -40°C to 85°C .

Device Information⁽¹⁾

PART NUMBER	PACKAGE	BODY SIZE (NOM)
CDCLVC1102	TSSOP (8)	3.00 mm x 4.40 mm
CDCLVC1103		
CDCLVC1104		
CDCLVC1106	TSSOP (14)	5.00 mm x 4.40 mm
CDCLVC1108	TSSOP (16)	
CDCLVC1110	TSSOP (20)	6.50 mm x 4.40 mm
CDCLVC1112	TSSOP (24)	7.80 mm x 4.40 mm

(1) For all available packages, see the orderable addendum at the end of the datasheet.

CLKIN	1		24	Y1
1G	2	CDCLVC 1102	23	Y3
Y0	3	CDCLVC 1103	22	VDD
GND	4	CDCLVC 1104	21	Y2
VDD	5		20	GND
Y4	6	CDCLVC 1106	19	Y5
GND	7		18	VDD
Y6	8	CDCLVC 1108	17	Y7
VDD	9		16	Y8
Y9	10	CDCLVC 1110	15	GND
GND	11		14	Y10
Y11	12	CDCLVC 1112	13	VDD



Table of Contents

1 Features	1	9.1 Overview	10
2 Applications	1	9.2 Functional Block Diagram	10
3 Description	1	9.3 Feature Description	11
4 Functional Block Diagram	1	9.4 Device Functional Modes	11
5 Revision History	2	10 Application and Implementation	12
6 Pin Configuration and Functions	3	10.1 Application Information	12
7 Specifications	4	10.2 Typical Application	12
7.1 Absolute Maximum Ratings	4	11 Power Supply Recommendations	14
7.2 Handling Ratings	4	12 Layout	14
7.3 Recommended Operating Conditions	4	12.1 Layout Guidelines	14
7.4 Thermal Information	5	12.2 Layout Example	14
7.5 Thermal Information	5	13 Device and Documentation Support	15
7.6 Electrical Characteristics	5	13.1 Related Links	15
7.7 Switching Characteristics	6	13.2 Trademarks	15
7.8 Typical Characteristics	7	13.3 Electrostatic Discharge Caution	15
8 Parameter Measurement Information	8	13.4 Glossary	15
9 Detailed Description	10	14 Mechanical, Packaging, and Orderable Information	15

5 Revision History

Changes from Original (May 2010) to Revision A

Page

- Added *ESD Ratings* table, *Feature Description* section, *Device Functional Modes*, *Application and Implementation* section, *Power Supply Recommendations* section, *Layout* section, *Device and Documentation Support* section, and *Mechanical, Packaging, and Orderable Information* section

1

6 Pin Configuration and Functions

PW Package
8-, 14-, 16-, 20-, 24-Pin TSSOP
Top View

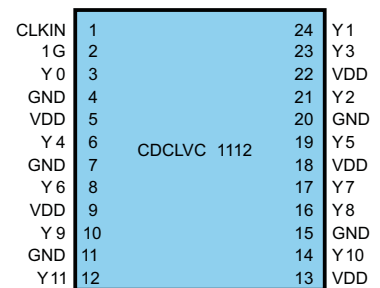
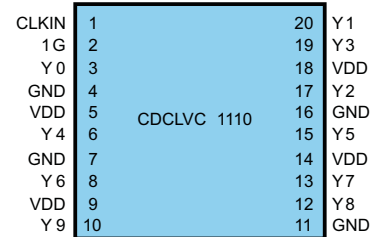
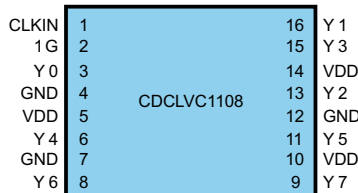
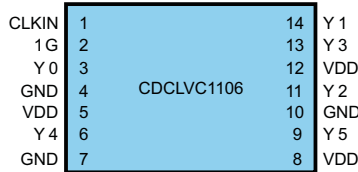
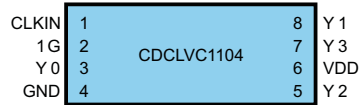
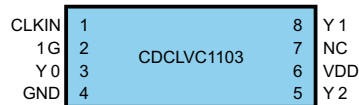
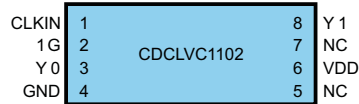

Pin Functions

NAME	PIN NO.							I/O	DESCRIPTION
	CDCLVC 1102	CDCLVC 1103	CDCLVC 1104	CDCLVC 1106	CDCLVC 1108	CDCLVC 1110	CDCLVC 1112		
LVC MOS CLOCK INPUT									
CLKIN	1	1	1	1	1	1	1	Input	Input Pin
CLOCK OUTPUT ENABLE									
1G	2	2	2	2	2	2	2	Input	Output Enable
LVC MOS CLOCK OUTPUT									
Y0	3	3	3	3	3	3	3	Output	LVC MOS output. Unused outputs can be left floating.
Y1	8	8	8	14	16	20	24		
Y2	—	5	5	11	13	17	21		
Y3	—	—	7	13	15	19	23		
Y4	—	—	—	6	6	6	6		
Y5	—	—	—	9	11	15	19		
Y6	—	—	—	—	8	8	8		
Y7	—	—	—	—	9	13	17		
Y8	—	—	—	—	—	10	16		
Y9	—	—	—	—	—	—	10		
Y10	—	—	—	—	—	—	14		
Y11	—	—	—	—	—	—	12		
SUPPLY VOLTAGE									
V _{DD}	6	6	6	5	5	5	5	Power	2.5-V or 3.3-V device supply
				8	10	14	18		
				12	14	18	22		
				9	9	13	18		

Pin Functions (continued)

NAME	PIN NO.							I/O	DESCRIPTION
	CDCLVC 1102	CDCLVC 1103	CDCLVC 1104	CDCLVC 1106	CDCLVC 1108	CDCLVC 1110	CDCLVC 1112		
GROUND									
GND	4	4	4	4	4	4	4	GND	Device ground
				7	7	7	7		
				7	7	11	11		
				10	12	16	20		

7 Specifications

7.1 Absolute Maximum Ratings⁽¹⁾

over operating free-air temperature range (unless otherwise noted)

		MIN	MAX	UNIT
V_{DD}	Supply voltage range	-0.5	4.6	V
V_{IN}	Input voltage range ⁽²⁾	-0.5	$V_{DD} + 0.5$	V
V_O	Output voltage range ⁽²⁾	-0.5	$V_{DD} + 0.5$	V
I_{IN}	Input current		±20	mA
I_O	Continuous output current		±50	mA
T_J	Maximum junction temperature		125	°C

- (1) Stresses beyond those listed under "absolute maximum ratings" may cause permanent damage to the device. These are stress ratings only and functional operation of the device at these or any other conditions beyond those indicated under "recommended operating conditions" is not implied. Exposure to absolute-maximum-rated conditions for extended periods may affect device reliability.
- (2) This value is limited to 4.6 V maximum.

7.2 Handling Ratings

		MIN	MAX	UNIT
T_{stg}	Storage temperature range	-65	150	°C
$V_{(ESD)}$	Electrostatic discharge	Human body model (HBM), per ANSI/ESDA/JEDEC JS-001, all pins ⁽¹⁾		V
		Charged device model (CDM), per JEDEC specification JESD22-C101, all pins ⁽²⁾		

- (1) JEDEC document JEP155 states that 500-V HBM allows safe manufacturing with a standard ESD control process.
- (2) JEDEC document JEP157 states that 250-V CDM allows safe manufacturing with a standard ESD control process.

7.3 Recommended Operating Conditions

over operating free-air temperature range (unless otherwise noted)

			MIN	NOM	MAX	UNIT
V_{DD}	Supply voltage range	3.3 V supply	3.0	3.3	3.6	V
		2.5 V supply	2.3	2.5	2.7	
V_{IL}	Low-level input voltage	$V_{DD} = 3.0\text{ V to }3.6\text{ V}$	$V_{DD}/2 - 600$			mV
		$V_{DD} = 2.3\text{ V to }2.7\text{ V}$	$V_{DD}/2 - 400$			
V_{IH}	High-level input voltage	$V_{DD} = 3.0\text{ V to }3.6\text{ V}$	$V_{DD}/2 + 600$			mV
		$V_{DD} = 2.3\text{ V to }2.7\text{ V}$	$V_{DD}/2 + 400$			
V_{th}	Input threshold voltage	$V_{DD} = 2.3\text{ V to }3.6\text{ V}$	$V_{DD}/2$			mV
t_r / t_f	Input slew rate		1		4	V/ns
t_w	Minimum pulse width at CLKIN	$V_{DD} = 3.0\text{ V to }3.6\text{ V}$	1.8			ns
		$V_{DD} = 2.3\text{ V to }2.7\text{ V}$	2.75			

Recommended Operating Conditions (continued)

over operating free-air temperature range (unless otherwise noted)

			MIN	NOM	MAX	UNIT
f _{CLK}	LVCMOS clock Input Frequency	V _{DD} = 3.0 V to 3.6 V	DC		250	MHz
		V _{DD} = 2.3 V to 2.7 V	DC		180	
T _A	Operating free-air temperature		-40		85	°C

7.4 Thermal Information

THERMAL METRIC ⁽¹⁾		CDCLVC1102 CDCLVC1103 CDCLVC1104	CDCLVC1106	CDCLVC1108	UNIT
		PW	PW	PW	
		8 PINS	14 PINS	16 PINS	
R _{θJA}	Junction-to-ambient thermal resistance ⁽²⁾	149.4	112.6	108.4	°C/W
R _{θJC(top)}	Junction-to-case(top) thermal resistance ⁽³⁾	69.4	48.0	33.6	

- (1) For more information about traditional and new thermal metrics, see the IC Package Thermal Metrics application report, [SPRA953](#).
- (2) The junction-to-ambient thermal resistance under natural convection is obtained in a simulation on a JEDEC-standard, high-K board, as specified in JESD51-7, in an environment described in JESD51-2a.
- (3) The junction-to-case (top) thermal resistance is obtained by simulating a cold plate test on the package top. No specific JEDEC-standard test exists, but a close description can be found in the ANSI SEMI standard G30-88.

7.5 Thermal Information

THERMAL METRIC ⁽¹⁾		CDCLVC11010	CDCLVC1112	UNIT
		PW	PW	
		20 PINS	24 PINS	
θ _{JA}	Junction-to-ambient thermal resistance ⁽²⁾	83.0	87.9	°C/W
θ _{JC(top)}	Junction-to-case(top) thermal resistance ⁽³⁾	32.3	26.5	

- (1) For more information about traditional and new thermal metrics, see the IC Package Thermal Metrics application report, [SPRA953](#).
- (2) The junction-to-ambient thermal resistance under natural convection is obtained in a simulation on a JEDEC-standard, high-K board, as specified in JESD51-7, in an environment described in JESD51-2a.
- (3) The junction-to-case (top) thermal resistance is obtained by simulating a cold plate test on the package top. No specific JEDEC-standard test exists, but a close description can be found in the ANSI SEMI standard G30-88.

7.6 Electrical Characteristics

Over recommended operating free-air temperature range (unless otherwise noted)

PARAMETER		TEST CONDITIONS	MIN	TYP ⁽¹⁾	MAX	UNIT
OVERALL PARAMETERS FOR ALL VERSIONS						
I _{DD}	Static device current ⁽²⁾	1G = V _{DD} ; CLKIN = 0 V or V _{DD} ; I _O = 0 mA; V _{DD} = 3.6 V		6	10	mA
		1G = V _{DD} ; CLKIN = 0 V or V _{DD} ; I _O = 0 mA; V _{DD} = 2.7 V		3	6	mA
I _{PD}	Power down current	1G = 0 V; CLKIN = 0 V or V _{DD} ; I _O = 0 mA; V _{DD} = 3.6 V or 2.7 V			60	μA
C _{PD}	Power dissipation capacitance per output ⁽³⁾	V _{DD} = 3.3 V; f = 10 MHz		6		pF
		V _{DD} = 2.5 V; f = 10 MHz		4.5		pF
I _I	Input leakage current at 1G	V _I = 0 V or V _{DD} ; V _{DD} = 3.6 V or 2.7 V			± 8	μA
	Input leakage current at CLKIN				± 25	
R _{OUT}	Output impedance	V _{DD} = 3.3 V		45		Ω
		V _{DD} = 2.5 V		60		Ω

- (1) All typical values are at respective nominal V_{DD}. For switching characteristics, outputs are terminated to 50 Ω to V_{DD}/2 (see [Figure 5](#)).
- (2) For dynamic I_{DD} over frequency see [Figure 1](#) and [Figure 2](#).
- (3) This is the formula for the power dissipation calculation (see [Figure 1](#) and the [Power Consideration](#) section).

$$\begin{aligned}
 P_{\text{tot}} &= P_{\text{stat}} + P_{\text{dyn}} + P_{\text{Cload}} \text{ [W]} \\
 P_{\text{stat}} &= V_{\text{DD}} \times I_{\text{DD}} \text{ [W]} \\
 P_{\text{dyn}} &= C_{\text{PD}} \times V_{\text{DD}}^2 \times f \text{ [W]} \\
 P_{\text{Cload}} &= C_{\text{load}} \times V_{\text{DD}}^2 \times f \times n \text{ [W]} \\
 n &= \text{Number of switching output pins}
 \end{aligned}$$

Electrical Characteristics (continued)

Over recommended operating free-air temperature range (unless otherwise noted)

PARAMETER	TEST CONDITIONS	MIN	TYP ⁽¹⁾	MAX	UNIT
f _{OUT} Output frequency	V _{DD} = 3.0 V to 3.6 V	DC		250	MHz
	V _{DD} = 2.3 V to 2.7 V	DC		180	MHz
OUTPUT PARAMETERS FOR V_{DD} = 3.3 V ± 0.3 V					
V _{OH} High-level output voltage	V _{DD} = 3 V, I _{OH} = -0.1 mA		2.9		V
	V _{DD} = 3 V, I _{OH} = -8 mA		2.5		
	V _{DD} = 3 V, I _{OH} = -12 mA		2.2		
V _{OL} Low-level output voltage	V _{DD} = 3 V, I _{OL} = 0.1 mA			0.1	V
	V _{DD} = 3 V, I _{OL} = 8 mA			0.5	
	V _{DD} = 3 V, I _{OL} = 12 mA			0.8	
OUTPUT PARAMETERS FOR V_{DD} = 2.5 V ± 0.2 V					
V _{OH} High-level output voltage	V _{DD} = 2.3 V, I _{OH} = -0.1 mA		2.2		V
	V _{DD} = 2.3 V, I _{OH} = -8 mA		1.7		
V _{OL} Low-level output voltage	V _{DD} = 2.3 V, I _{OL} = 0.1 mA			0.1	V
	V _{DD} = 2.3 V, I _{OL} = 8 mA			0.5	

7.7 Switching Characteristics

over operating free-air temperature range (unless otherwise noted)

PARAMETER	TEST CONDITIONS	MIN	TYP	MAX	UNIT
OUTPUT PARAMETERS FOR V_{DD} = 3.3 V ± 0.3 V					
t _{PLH} , t _{PHL} Propagation delay	CLKIN to Yn	0.8		2.0	ns
t _{sk(o)} Output skew	Equal load of each output			50	ps
t _r /t _f Rise and fall time	20%–80% (V _{OH} - V _{OL})	0.3		0.8	ns
t _{DIS} Output disable time	1G to Yn			6	ns
t _{EN} Output enable time	1G to Yn			6	ns
t _{sk(p)} Pulse skew ; t _{PLH(Yn)} - t _{PHL(Yn)} ⁽¹⁾	To be measured with input duty cycle of 50%			180	ps
t _{sk(pp)} Part-to-part skew	Under equal operating conditions for two parts			0.5	ns
t _{jitter} Additive jitter rms ⁽²⁾	12 kHz to 20 MHz, f _{OUT} = 250 MHz			100	fs
OUTPUT PARAMETERS FOR V_{DD} = 2.5 V ± 0.2 V					
t _{PLH} , t _{PHL} Propagation delay	CLKIN to Yn	1.0		2.6	ns
t _{sk(o)} Output skew	Equal load of each output			50	ps
t _r /t _f Rise and fall time	20%–80% reference point	0.3		1.2	ns
t _{DIS} Output disable time	1G to Yn			10	ns
t _{EN} Output enable time	1G to Yn			10	ns
t _{sk(p)} Pulse skew ; t _{PLH(Yn)} - t _{PHL(Yn)} ⁽¹⁾	To be measured with input duty cycle of 50%			220	ps
t _{sk(pp)} Part-to-part skew	Under equal operating conditions for two parts			1.2	ns
t _{jitter} Additive jitter rms ⁽²⁾	12 kHz to 20 MHz, f _{OUT} = 180 MHz			350	fs

(1) t_{sk(p)} depends on output rise- and fall-time (t_r/t_f). The output duty-cycle can be calculated: odc = (t_{w(OUT)} ± t_{sk(p)})/t_{period}; t_{w(OUT)} is pulse-width of output waveform and t_{period} is 1/f_{OUT}.

(2) Parameter is specified by characterization. Not tested in production.

7.8 Typical Characteristics

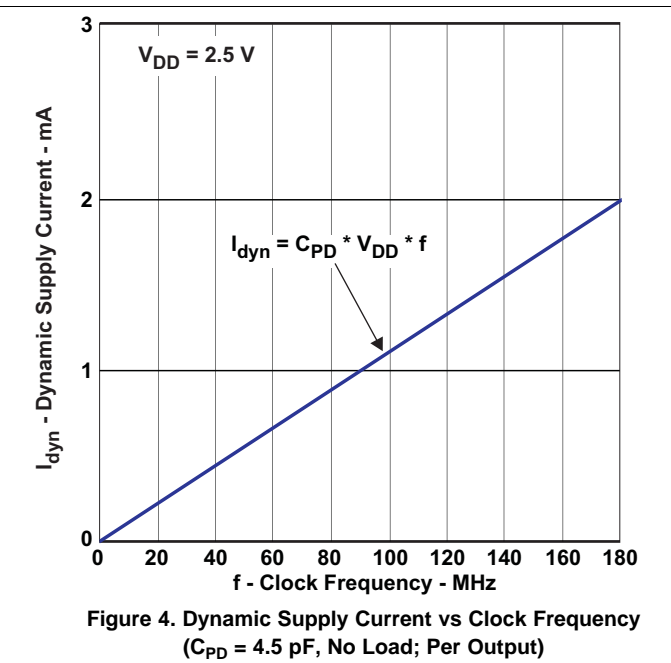
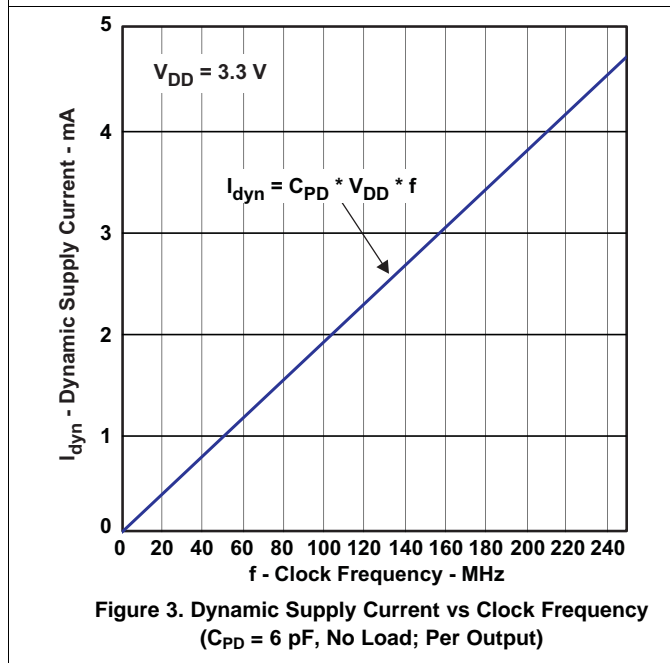
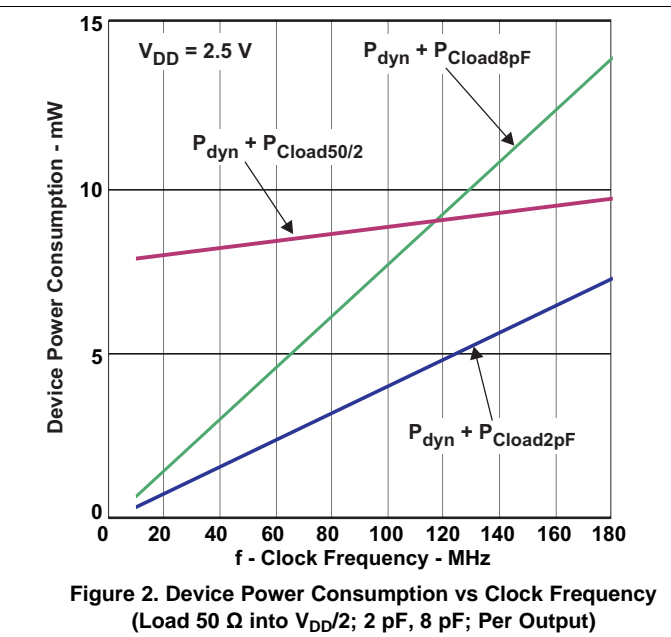
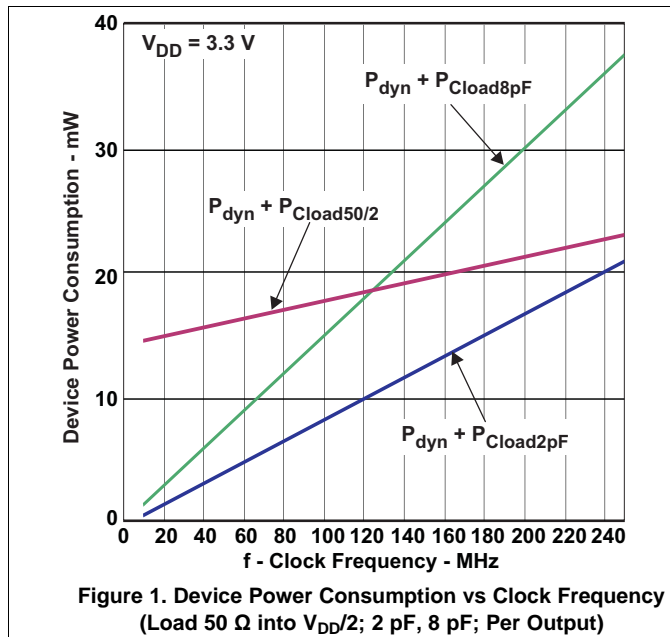

8 Parameter Measurement Information

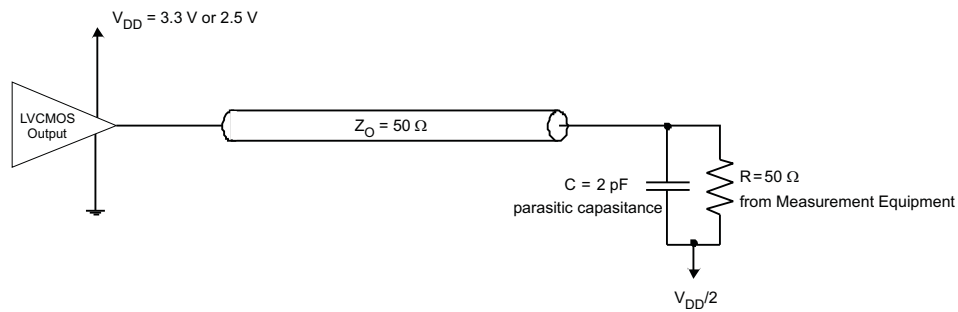

Figure 5. Test Load Circuit

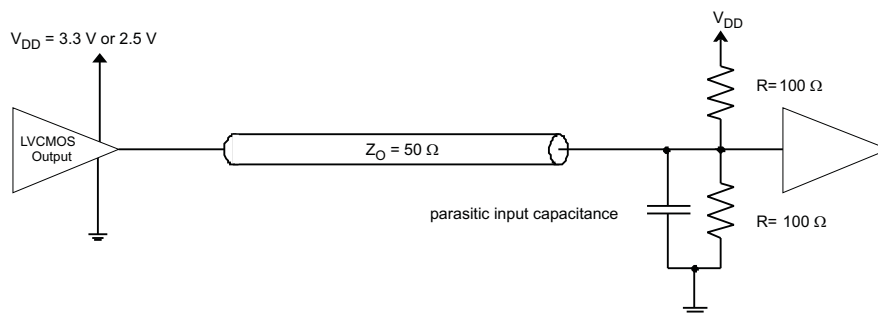

Figure 6. Application Load With 50-Ω Line Termination

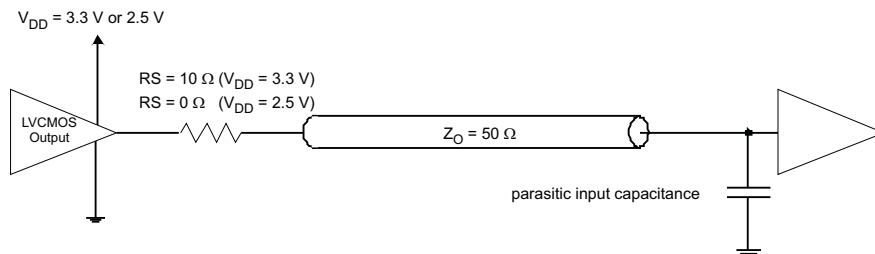

Figure 7. Application Load With Series Line Termination

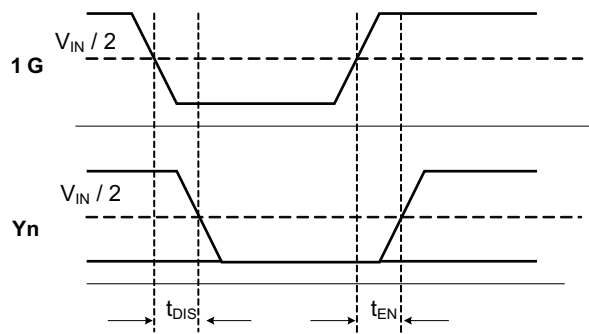

Figure 8. t_{DIS} and t_{EN} for Disable Low

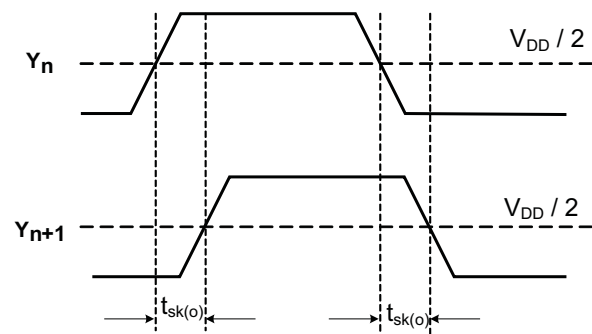
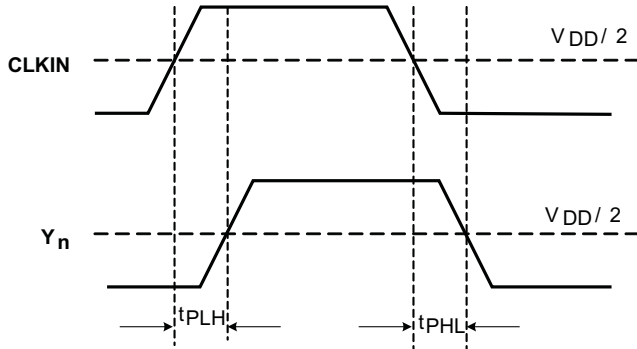

Figure 9. Output Skew $t_{sk(o)}$

Parameter Measurement Information (continued)



Note: $t_{sk(p)} = |t_{PLH} - t_{PHL}|$

Figure 10. Pulse Skew $t_{sk(p)}$ and Propagation Delay t_{PLH}/t_{PHL}

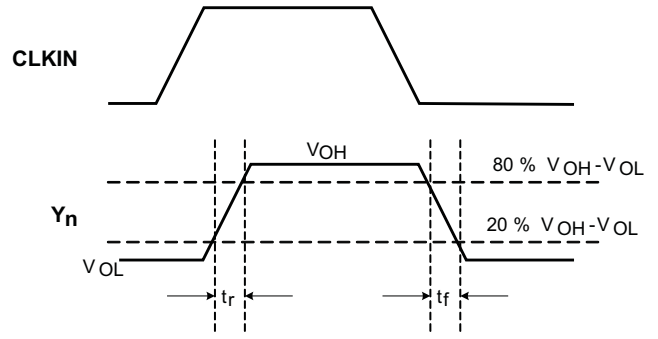

Figure 11. Rise/Fall Times t_r/t_f

9 Detailed Description

9.1 Overview

The CDCLVC11xx family of devices is a low-jitter and low-skew LVCMOS fan-out buffer solution. For best signal integrity, it is important to match the characteristic impedance of the CDCLVC11xx's output driver with that of the transmission line. [Figure 7](#) and [Figure 8](#) show the proper configuration per configuration for both $V_{DD} = 3.3\text{ V}$ and $V_{DD} = 2.5\text{ V}$. TI recommends placing the series resistor close to the driver to minimize signal reflection.

9.2 Functional Block Diagram

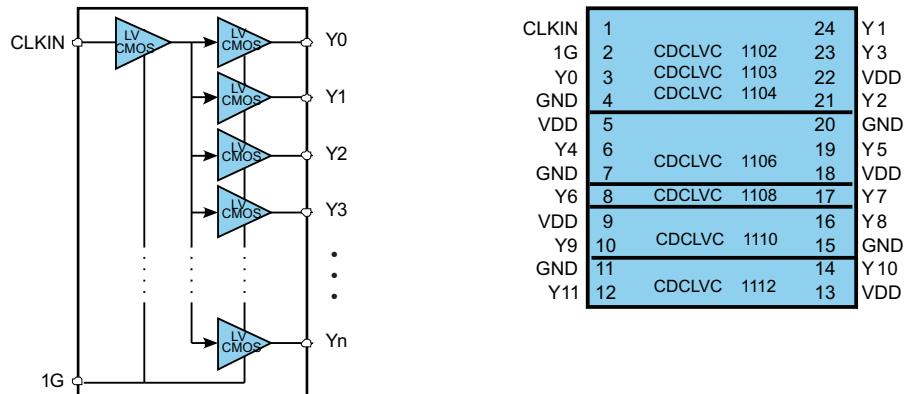

Table 1. Output Logic Table

INPUTS		OUTPUTS
CLKIN	1G	Yn
X	L	L
L	H	L
H	H	H

9.3 Feature Description

9.3.1 Power Consideration

The following power consideration refers to the device-consumed power consumption only. The device power consumption is the sum of static power and dynamic power. The dynamic power usage consists of two components:

- Power used by the device as it switches states.
- Power required to charge any output load.

The output load can be capacitive only or capacitive and resistive. The following formula and the power graphs in [Figure 1](#) and [Figure 2](#) can be used to obtain the power consumption of the device:

$$P_{\text{dev}} = P_{\text{stat}} + n (P_{\text{dyn}} + P_{\text{Cload}})$$

$$P_{\text{stat}} = V_{\text{DD}} \times I_{\text{DD}}$$

$$P_{\text{dyn}} + P_{\text{Cload}} = \text{see } \text{Figure 1} \text{ and } \text{Figure 2}$$

where:

$$V_{\text{DD}} = \text{Supply voltage (3.3 V or 2.5 V)}$$

$$I_{\text{DD}} = \text{Static device current (typ 6 mA for } V_{\text{DD}} = 3.3 \text{ V; typ 3 mA for } V_{\text{DD}} = 2.5 \text{ V)}$$

$$n = \text{Number of switching output pins}$$

Example for device power consumption for CDCLVC1104: four outputs are switching, $f = 120 \text{ MHz}$, $V_{\text{DD}} = 3.3 \text{ V}$ and $C_{\text{load}} = 2 \text{ pF}$ per output:

$$P_{\text{dev}} = P_{\text{stat}} + n (P_{\text{dyn}} + P_{\text{Cload}}) = 19.8 \text{ mW} + 40 \text{ mW} = 59.8 \text{ mW}$$

$$P_{\text{stat}} = V_{\text{DD}} \times I_{\text{DD}} = 6 \text{ mA} \times 3.3 \text{ V} = 19.8 \text{ mW}$$

$$n (P_{\text{dyn}} + P_{\text{Cload}}) = 4 \times 10 \text{ mW} = 40 \text{ mW}$$

NOTE

For dimensioning the power supply, the total power consumption must be considered. The total power consumption is the sum of the device power consumption and the power consumption of the load.

9.4 Device Functional Modes

The outputs of the CDCLVC11xx can be disabled by driving the asynchronous output enable pin (1G) low. Unused outputs can be left floating to reduce overall system component cost. All supply and ground pins must be connected to V_{DD} and GND, respectively.

10 Application and Implementation

NOTE

Information in the following applications sections is not part of the TI component specification, and TI does not warrant its accuracy or completeness. TI's customers are responsible for determining suitability of components for their purposes. Customers should validate and test their design implementation to confirm system functionality.

10.1 Application Information

The CDCLVC11xx family is a low additive jitter LVCMOS buffer solution that can operate up to 250 MHz at $V_{DD} = 3.3$ V and 180 MHz at $V_{DD} = 2.5$ V. Low output skew as well as the ability for asynchronous output enable is featured to simultaneously enable or disable buffered clock outputs as necessary in the application.

10.2 Typical Application

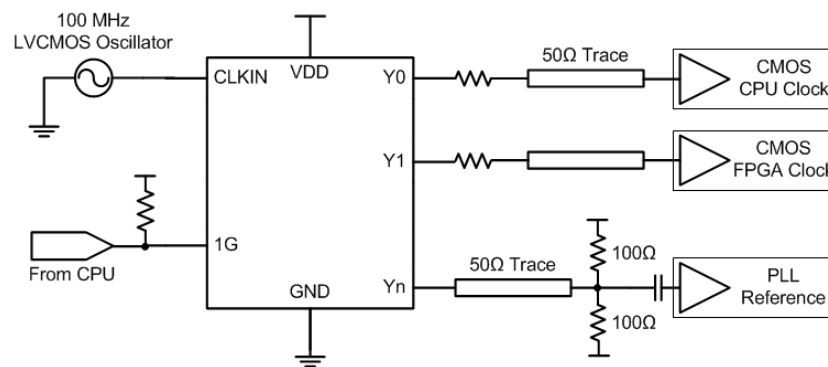

Figure 12. Example System Configuration

10.2.1 Design Requirements

The CDCLVC11xx shown in [Figure 12](#) is configured to fan out a 100-MHz signal from a local LVCMOS oscillator. The CPU is configured to control the output state via 1G.

The configuration example is driving three LVCMOS receivers in a backplane application with the following properties:

- The CPU clock can accept a full swing DC-coupled LVCMOS signal. A series resistor is placed near the CDCLVC11xx to closely match the characteristic impedance of the trace to minimize reflections.
- The FPGA clock is similarly DC-coupled with an appropriate series resistor placed near the CDCLVC11xx.
- The PLL in this example can accept a lower amplitude signal, so a Thevenin's equivalent termination is used. The PLL receiver features internal biasing, so AC-coupling can be used when common mode voltage is mismatched.

10.2.2 Detailed Design Procedure

Refer to [Figure 7](#) and the [Electrical Characteristics](#) table to determine the appropriate series resistance needed for matching the output impedance of the CDCLVC11xx to that of the characteristic impedance of the transmission line.

Unused outputs can be left floating. See the [Power Supply Recommendations](#) section for recommended filtering techniques.

Typical Application (continued)

10.2.3 Application Curves

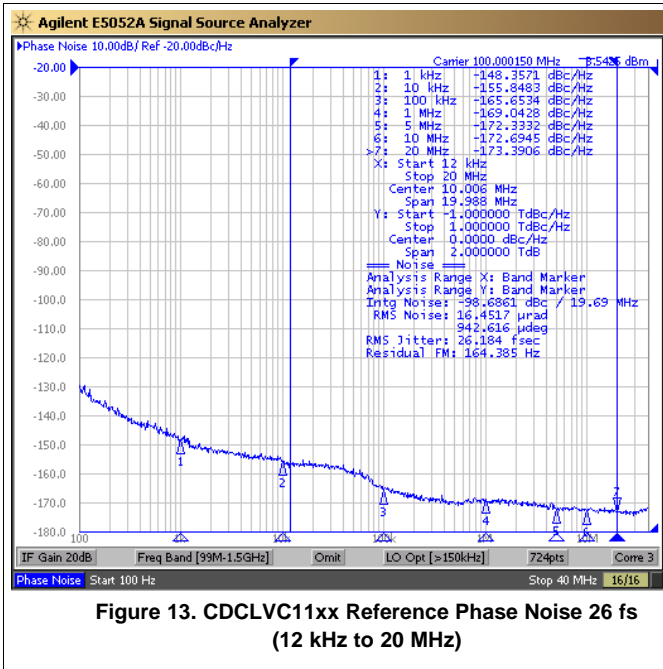

Figure 13. CDCLVC11xx Reference Phase Noise 26 fs (12 kHz to 20 MHz)

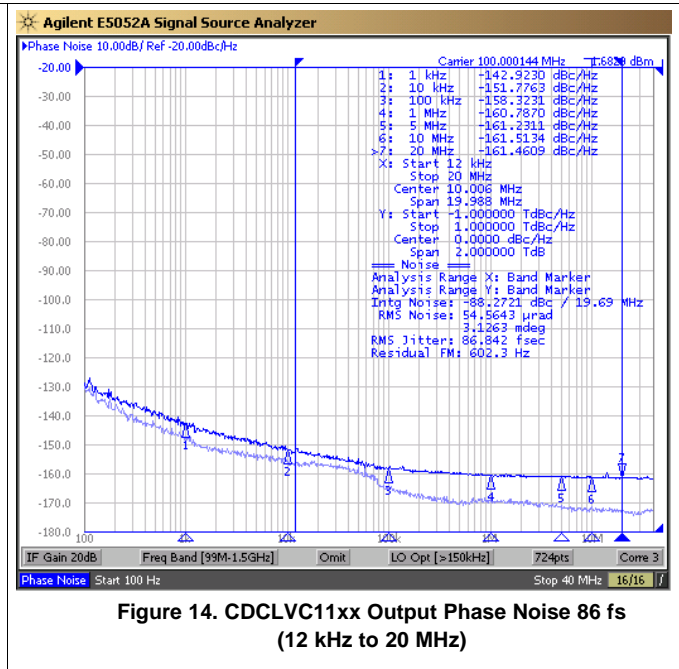

Figure 14. CDCLVC11xx Output Phase Noise 86 fs (12 kHz to 20 MHz)

The low additive jitter of the CDCLVC11xx can be shown in the previous application example. The low-noise 100-MHz XO with 26-fs RMS jitter drives the CDCLVC11xx, resulting in 86-fs RMS jitter when integrated from 12 kHz to 20 MHz. The resultant additive jitter is a low 82-fs RMS for this configuration.

11 Power Supply Recommendations

High-performance clock buffers are sensitive to noise on the power supply, which can dramatically increase the additive jitter of the buffer. Thus, it is essential to reduce noise from the system power supply, especially when jitter/phase noise is critical to applications.

Filter capacitors are used to eliminate the low-frequency noise from the power supply, where the bypass capacitors provide the very low impedance path for high-frequency noise and guards the power supply system against induced fluctuations. These bypass capacitors also provide instantaneous current surges as required by the device and should have low equivalent series resistance (ESR). To properly use the bypass capacitors, they must be placed very close to the power-supply terminals and laid out with short loops to minimize inductance. TI recommends adding as many high-frequency (for example, 0.1 μF) bypass capacitors, as there are supply terminals in the package. TI recommends, but does not require, inserting a ferrite bead between the board power supply and the chip power supply that isolates the high-frequency switching noises generated by the clock buffer; these beads prevent the switching noise from leaking into the board supply. It is imperative to choose an appropriate ferrite bead with very low DC resistance to provide adequate isolation between the board supply and the chip supply, as well as to maintain a voltage at the supply terminals that is greater than the minimum voltage required for proper operation.

Figure 15 shows this recommended power supply decoupling method.

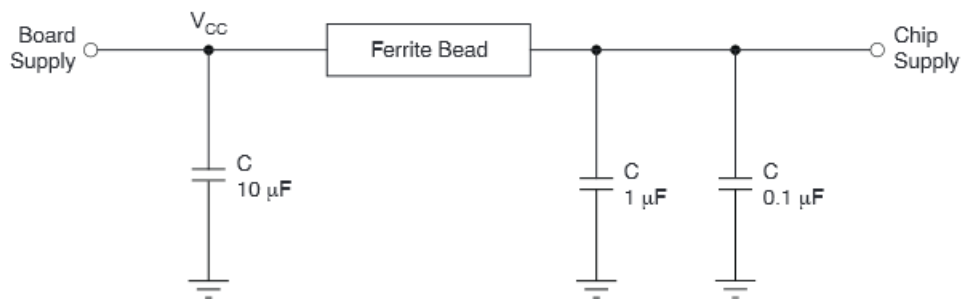

Figure 15. Power Supply Decoupling

12 Layout

12.1 Layout Guidelines

Figure 16 shows a conceptual layout detailing recommended placement of power supply bypass capacitors. For component side mounting, use 0402 body size capacitors to facilitate signal routing. Keep the connections between the bypass capacitors and the power supply on the device as short as possible. Ground the other side of the capacitor using a low-impedance connection to the ground plane.

12.2 Layout Example

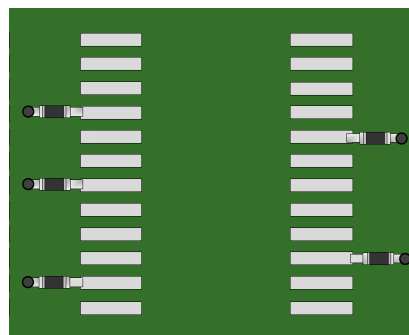

Figure 16. PCB Conceptual Layout

13 Device and Documentation Support

13.1 Related Links

The table below lists quick access links. Categories include technical documents, support and community resources, tools and software, and quick access to sample or buy.

Table 2. Related Links

PARTS	PRODUCT FOLDER	SAMPLE & BUY	TECHNICAL DOCUMENTS	TOOLS & SOFTWARE	SUPPORT & COMMUNITY
CDCLVC1102	Click here	Click here	Click here	Click here	Click here
CDCLVC1103	Click here	Click here	Click here	Click here	Click here
CDCLVC1104	Click here	Click here	Click here	Click here	Click here
CDCLVC1106	Click here	Click here	Click here	Click here	Click here
CDCLVC1108	Click here	Click here	Click here	Click here	Click here
CDCLVC1110	Click here	Click here	Click here	Click here	Click here
CDCLVC1112	Click here	Click here	Click here	Click here	Click here

13.2 Trademarks

All trademarks are the property of their respective owners.

13.3 Electrostatic Discharge Caution



These devices have limited built-in ESD protection. The leads should be shorted together or the device placed in conductive foam during storage or handling to prevent electrostatic damage to the MOS gates.

13.4 Glossary

[SLYZ022](#) — *TI Glossary*.

This glossary lists and explains terms, acronyms, and definitions.

14 Mechanical, Packaging, and Orderable Information

The following pages include mechanical, packaging, and orderable information. This information is the most current data available for the designated devices. This data is subject to change without notice and revision of this document. For browser-based versions of this data sheet, refer to the left-hand navigation.

PACKAGING INFORMATION

Orderable Device	Status (1)	Package Type	Package Drawing	Pins	Package Qty	Eco Plan (2)	Lead/Ball Finish (6)	MSL Peak Temp (3)	Op Temp (°C)	Device Marking (4/5)	Samples
CDCLVC1102PW	ACTIVE	TSSOP	PW	8	150	Green (RoHS & no Sb/Br)	CU NIPDAU	Level-1-260C-UNLIM	-40 to 85	C9C2	Samples
CDCLVC1102PWR	ACTIVE	TSSOP	PW	8	2000	Green (RoHS & no Sb/Br)	CU NIPDAU	Level-1-260C-UNLIM	-40 to 85	C9C2	Samples
CDCLVC1103PW	ACTIVE	TSSOP	PW	8	150	Green (RoHS & no Sb/Br)	CU NIPDAU	Level-1-260C-UNLIM	-40 to 85	C9C3	Samples
CDCLVC1103PWR	ACTIVE	TSSOP	PW	8	2000	Green (RoHS & no Sb/Br)	CU NIPDAU	Level-1-260C-UNLIM	-40 to 85	C9C3	Samples
CDCLVC1104PW	ACTIVE	TSSOP	PW	8	150	Green (RoHS & no Sb/Br)	CU NIPDAU	Level-1-260C-UNLIM	-40 to 85	C9C4	Samples
CDCLVC1104PWR	ACTIVE	TSSOP	PW	8	2000	Green (RoHS & no Sb/Br)	CU NIPDAU	Level-1-260C-UNLIM	-40 to 85	C9C4	Samples
CDCLVC1106PW	ACTIVE	TSSOP	PW	14	90	Green (RoHS & no Sb/Br)	CU NIPDAU	Level-1-260C-UNLIM	-40 to 85	C9C6	Samples
CDCLVC1106PWR	ACTIVE	TSSOP	PW	14	2000	Green (RoHS & no Sb/Br)	CU NIPDAU	Level-1-260C-UNLIM	-40 to 85	C9C6	Samples
CDCLVC1108PW	ACTIVE	TSSOP	PW	16	90	Green (RoHS & no Sb/Br)	CU NIPDAU	Level-1-260C-UNLIM	-40 to 85	C9C8	Samples
CDCLVC1108PWR	ACTIVE	TSSOP	PW	16	2000	Green (RoHS & no Sb/Br)	CU NIPDAU	Level-1-260C-UNLIM	-40 to 85	C9C8	Samples
CDCLVC1110PW	ACTIVE	TSSOP	PW	20	70	Green (RoHS & no Sb/Br)	CU NIPDAU	Level-1-260C-UNLIM	-40 to 85	C9CA	Samples
CDCLVC1110PWR	ACTIVE	TSSOP	PW	20	2000	Green (RoHS & no Sb/Br)	CU NIPDAU	Level-1-260C-UNLIM	-40 to 85	C9CA	Samples
CDCLVC1112PW	ACTIVE	TSSOP	PW	24	60	Green (RoHS & no Sb/Br)	CU NIPDAU	Level-1-260C-UNLIM	-40 to 85	C9CC	Samples
CDCLVC1112PWR	ACTIVE	TSSOP	PW	24	2000	Green (RoHS & no Sb/Br)	CU NIPDAU	Level-1-260C-UNLIM	-40 to 85	C9CC	Samples

(1) The marketing status values are defined as follows:

ACTIVE: Product device recommended for new designs.

LIFEBUY: TI has announced that the device will be discontinued, and a lifetime-buy period is in effect.

NRND: Not recommended for new designs. Device is in production to support existing customers, but TI does not recommend using this part in a new design.

PREVIEW: Device has been announced but is not in production. Samples may or may not be available.

OBSOLETE: TI has discontinued the production of the device.

⁽²⁾ Eco Plan - The planned eco-friendly classification: Pb-Free (RoHS), Pb-Free (RoHS Exempt), or Green (RoHS & no Sb/Br) - please check <http://www.ti.com/productcontent> for the latest availability information and additional product content details.

TBD: The Pb-Free/Green conversion plan has not been defined.

Pb-Free (RoHS): TI's terms "Lead-Free" or "Pb-Free" mean semiconductor products that are compatible with the current RoHS requirements for all 6 substances, including the requirement that lead not exceed 0.1% by weight in homogeneous materials. Where designed to be soldered at high temperatures, TI Pb-Free products are suitable for use in specified lead-free processes.

Pb-Free (RoHS Exempt): This component has a RoHS exemption for either 1) lead-based flip-chip solder bumps used between the die and package, or 2) lead-based die adhesive used between the die and leadframe. The component is otherwise considered Pb-Free (RoHS compatible) as defined above.

Green (RoHS & no Sb/Br): TI defines "Green" to mean Pb-Free (RoHS compatible), and free of Bromine (Br) and Antimony (Sb) based flame retardants (Br or Sb do not exceed 0.1% by weight in homogeneous material)

⁽³⁾ MSL, Peak Temp. - The Moisture Sensitivity Level rating according to the JEDEC industry standard classifications, and peak solder temperature.

⁽⁴⁾ There may be additional marking, which relates to the logo, the lot trace code information, or the environmental category on the device.

⁽⁵⁾ Multiple Device Markings will be inside parentheses. Only one Device Marking contained in parentheses and separated by a "~" will appear on a device. If a line is indented then it is a continuation of the previous line and the two combined represent the entire Device Marking for that device.

⁽⁶⁾ Lead/Ball Finish - Orderable Devices may have multiple material finish options. Finish options are separated by a vertical ruled line. Lead/Ball Finish values may wrap to two lines if the finish value exceeds the maximum column width.

Important Information and Disclaimer:The information provided on this page represents TI's knowledge and belief as of the date that it is provided. TI bases its knowledge and belief on information provided by third parties, and makes no representation or warranty as to the accuracy of such information. Efforts are underway to better integrate information from third parties. TI has taken and continues to take reasonable steps to provide representative and accurate information but may not have conducted destructive testing or chemical analysis on incoming materials and chemicals. TI and TI suppliers consider certain information to be proprietary, and thus CAS numbers and other limited information may not be available for release.

In no event shall TI's liability arising out of such information exceed the total purchase price of the TI part(s) at issue in this document sold by TI to Customer on an annual basis.

TAPE AND REEL INFORMATION



QUADRANT ASSIGNMENTS FOR PIN 1 ORIENTATION IN TAPE



*All dimensions are nominal

Device	Package Type	Package Drawing	Pins	SPQ	Reel Diameter (mm)	Reel Width W1 (mm)	A0 (mm)	B0 (mm)	K0 (mm)	P1 (mm)	W (mm)	Pin1 Quadrant
CDCLVC1106PWR	TSSOP	PW	14	2000	330.0	12.4	6.9	5.6	1.6	8.0	12.0	Q1
CDCLVC1108PWR	TSSOP	PW	16	2000	330.0	12.4	6.9	5.6	1.6	8.0	12.0	Q1
CDCLVC1110PWR	TSSOP	PW	20	2000	330.0	16.4	6.95	7.1	1.6	8.0	16.0	Q1
CDCLVC1112PWR	TSSOP	PW	24	2000	330.0	16.4	6.95	8.3	1.6	8.0	16.0	Q1

TAPE AND REEL BOX DIMENSIONS

*All dimensions are nominal

Device	Package Type	Package Drawing	Pins	SPQ	Length (mm)	Width (mm)	Height (mm)
CDCLVC1106PWR	TSSOP	PW	14	2000	367.0	367.0	35.0
CDCLVC1108PWR	TSSOP	PW	16	2000	367.0	367.0	35.0
CDCLVC1110PWR	TSSOP	PW	20	2000	367.0	367.0	38.0
CDCLVC1112PWR	TSSOP	PW	24	2000	367.0	367.0	38.0

PW (R-PDSO-G14)

PLASTIC SMALL OUTLINE



4040064-3/G 02/11

- NOTES:
- A. All linear dimensions are in millimeters. Dimensioning and tolerancing per ASME Y14.5M-1994.
 - B. This drawing is subject to change without notice.
 - C. Body length does not include mold flash, protrusions, or gate burrs. Mold flash, protrusions, or gate burrs shall not exceed 0,15 each side.
 - D. Body width does not include interlead flash. Interlead flash shall not exceed 0,25 each side.
 - E. Falls within JEDEC MO-153

PW (R-PDSO-G14)

PLASTIC SMALL OUTLINE



- NOTES:
- All linear dimensions are in millimeters.
 - This drawing is subject to change without notice.
 - Publication IPC-7351 is recommended for alternate designs.
 - Laser cutting apertures with trapezoidal walls and also rounding corners will offer better paste release. Customers should contact their board assembly site for stencil design recommendations. Refer to IPC-7525 for other stencil recommendations.
 - Customers should contact their board fabrication site for solder mask tolerances between and around signal pads.

PW (R-PDSO-G16)

PLASTIC SMALL OUTLINE



4040064-4/G 02/11

- NOTES:
- A. All linear dimensions are in millimeters. Dimensioning and tolerancing per ASME Y14.5M-1994.
 - B. This drawing is subject to change without notice.
 - C. Body length does not include mold flash, protrusions, or gate burrs. Mold flash, protrusions, or gate burrs shall not exceed 0,15 each side.
 - D. Body width does not include interlead flash. Interlead flash shall not exceed 0,25 each side.
 - E. Falls within JEDEC MO-153

PW (R-PDSO-G16)

PLASTIC SMALL OUTLINE



- NOTES:
- A. All linear dimensions are in millimeters.
 - B. This drawing is subject to change without notice.
 - C. Publication IPC-7351 is recommended for alternate designs.
 - D. Laser cutting apertures with trapezoidal walls and also rounding corners will offer better paste release. Customers should contact their board assembly site for stencil design recommendations. Refer to IPC-7525 for other stencil recommendations.
 - E. Customers should contact their board fabrication site for solder mask tolerances between and around signal pads.

PW (R-PDSO-G20)

PLASTIC SMALL OUTLINE



- NOTES:
- A. All linear dimensions are in millimeters. Dimensioning and tolerancing per ASME Y14.5M-1994.
 - B. This drawing is subject to change without notice.
 -  C. Body length does not include mold flash, protrusions, or gate burrs. Mold flash, protrusions, or gate burrs shall not exceed 0,15 each side.
 -  D. Body width does not include interlead flash. Interlead flash shall not exceed 0,25 each side.
 - E. Falls within JEDEC MO-153

PW (R-PDSO-G20)

PLASTIC SMALL OUTLINE



- NOTES:
- A. All linear dimensions are in millimeters.
 - B. This drawing is subject to change without notice.
 - C. Publication IPC-7351 is recommended for alternate design.
 - D. Laser cutting apertures with trapezoidal walls and also rounding corners will offer better paste release. Customers should contact their board assembly site for stencil design recommendations. Refer to IPC-7525 for other stencil recommendations.
 - E. Customers should contact their board fabrication site for solder mask tolerances between and around signal pads.

PW (R-PDSO-G24)

PLASTIC SMALL OUTLINE



4040064-6/G 02/11

- NOTES:
- A. All linear dimensions are in millimeters. Dimensioning and tolerancing per ASME Y14.5M-1994.
 - B. This drawing is subject to change without notice.
 -  C. Body length does not include mold flash, protrusions, or gate burrs. Mold flash, protrusions, or gate burrs shall not exceed 0,15 each side.
 -  D. Body width does not include interlead flash. Interlead flash shall not exceed 0,25 each side.
 - E. Falls within JEDEC MO-153

PW (R-PDSO-G24)

PLASTIC SMALL OUTLINE

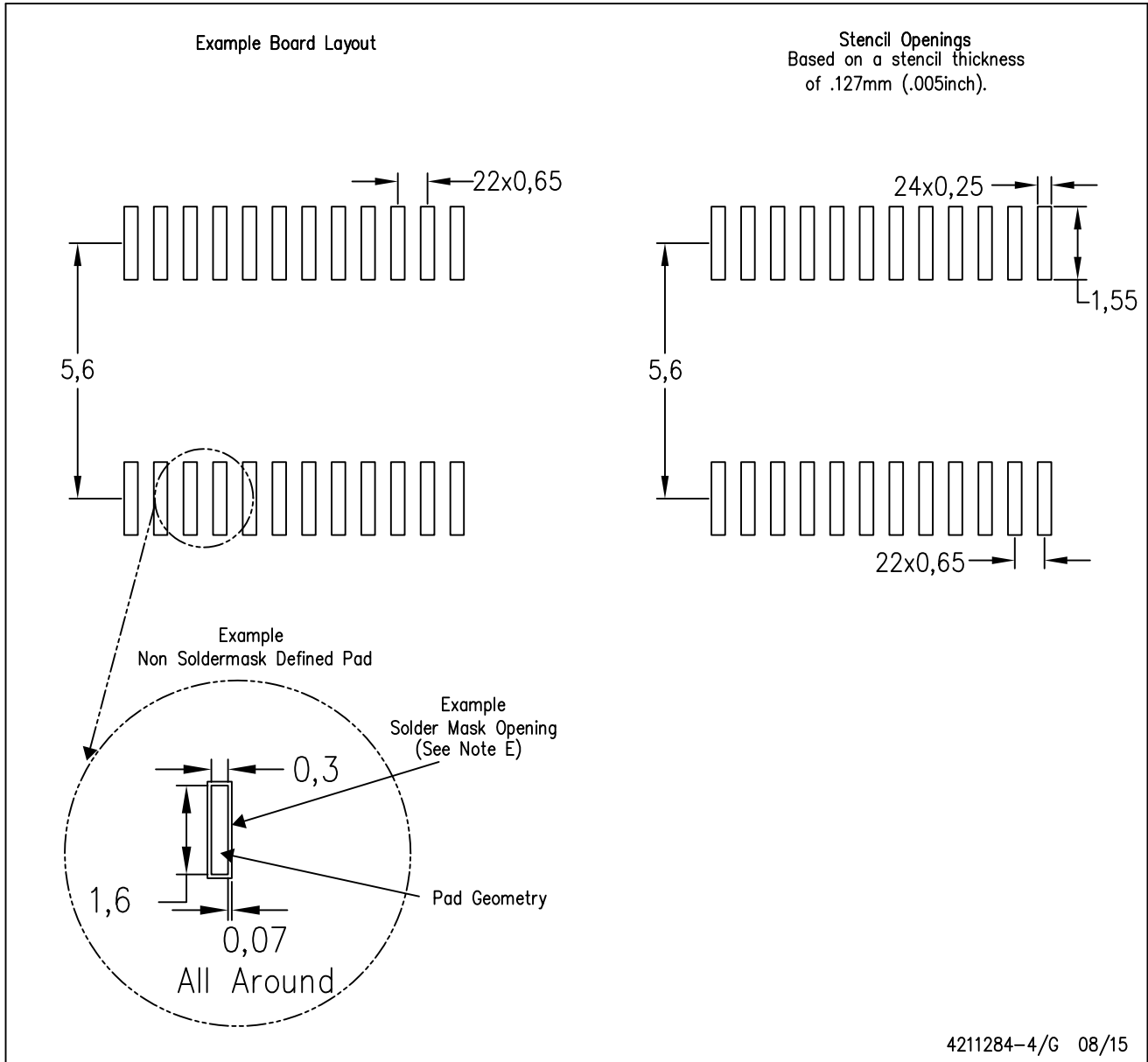

- NOTES:
- All linear dimensions are in millimeters.
 - This drawing is subject to change without notice.
 - Publication IPC-7351 is recommended for alternate design.
 - Laser cutting apertures with trapezoidal walls and also rounding corners will offer better paste release. Customers should contact their board assembly site for stencil design recommendations. Refer to IPC-7525 for other stencil recommendations.
 - Customers should contact their board fabrication site for solder mask tolerances between and around signal pads.

PW0008A



PACKAGE OUTLINE
TSSOP - 1.2 mm max height

SMALL OUTLINE PACKAGE

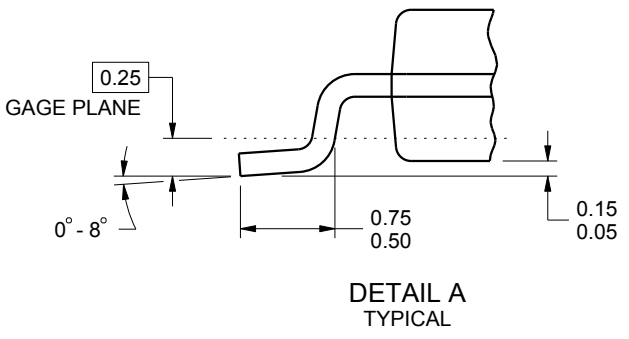
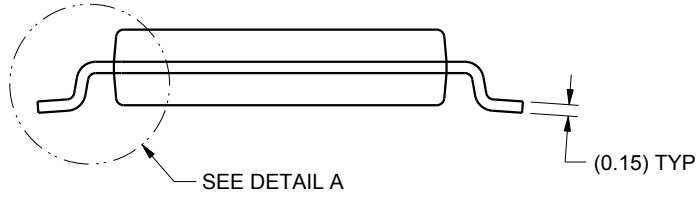
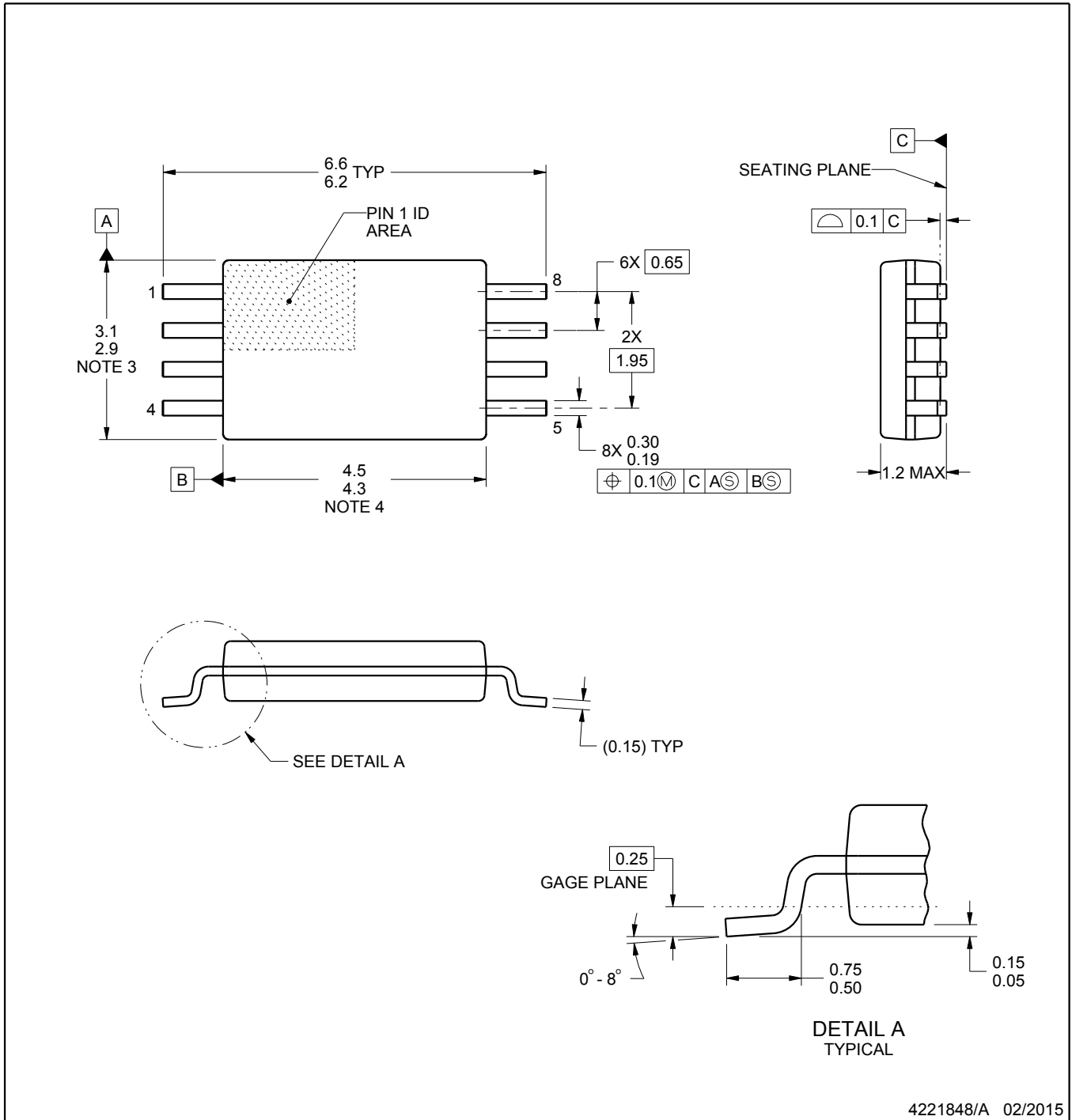

4221848/A 02/2015

NOTES:

1. All linear dimensions are in millimeters. Any dimensions in parenthesis are for reference only. Dimensioning and tolerancing per ASME Y14.5M.
2. This drawing is subject to change without notice.
3. This dimension does not include mold flash, protrusions, or gate burrs. Mold flash, protrusions, or gate burrs shall not exceed 0.15 mm per side.
4. This dimension does not include interlead flash. Interlead flash shall not exceed 0.25 mm per side.
5. Reference JEDEC registration MO-153, variation AA.

EXAMPLE BOARD LAYOUT

PW0008A

TSSOP - 1.2 mm max height

SMALL OUTLINE PACKAGE



LAND PATTERN EXAMPLE
SCALE:10X



SOLDER MASK DETAILS
NOT TO SCALE

4221848/A 02/2015

NOTES: (continued)

- 6. Publication IPC-7351 may have alternate designs.
- 7. Solder mask tolerances between and around signal pads can vary based on board fabrication site.

EXAMPLE STENCIL DESIGN

PW0008A

TSSOP - 1.2 mm max height

SMALL OUTLINE PACKAGE



SOLDER PASTE EXAMPLE
BASED ON 0.125 mm THICK STENCIL
SCALE:10X

4221848/A 02/2015

NOTES: (continued)

8. Laser cutting apertures with trapezoidal walls and rounded corners may offer better paste release. IPC-7525 may have alternate design recommendations.
9. Board assembly site may have different recommendations for stencil design.

IMPORTANT NOTICE

Texas Instruments Incorporated and its subsidiaries (TI) reserve the right to make corrections, enhancements, improvements and other changes to its semiconductor products and services per JESD46, latest issue, and to discontinue any product or service per JESD48, latest issue. Buyers should obtain the latest relevant information before placing orders and should verify that such information is current and complete. All semiconductor products (also referred to herein as "components") are sold subject to TI's terms and conditions of sale supplied at the time of order acknowledgment.

TI warrants performance of its components to the specifications applicable at the time of sale, in accordance with the warranty in TI's terms and conditions of sale of semiconductor products. Testing and other quality control techniques are used to the extent TI deems necessary to support this warranty. Except where mandated by applicable law, testing of all parameters of each component is not necessarily performed.

TI assumes no liability for applications assistance or the design of Buyers' products. Buyers are responsible for their products and applications using TI components. To minimize the risks associated with Buyers' products and applications, Buyers should provide adequate design and operating safeguards.

TI does not warrant or represent that any license, either express or implied, is granted under any patent right, copyright, mask work right, or other intellectual property right relating to any combination, machine, or process in which TI components or services are used. Information published by TI regarding third-party products or services does not constitute a license to use such products or services or a warranty or endorsement thereof. Use of such information may require a license from a third party under the patents or other intellectual property of the third party, or a license from TI under the patents or other intellectual property of TI.

Reproduction of significant portions of TI information in TI data books or data sheets is permissible only if reproduction is without alteration and is accompanied by all associated warranties, conditions, limitations, and notices. TI is not responsible or liable for such altered documentation. Information of third parties may be subject to additional restrictions.

Resale of TI components or services with statements different from or beyond the parameters stated by TI for that component or service voids all express and any implied warranties for the associated TI component or service and is an unfair and deceptive business practice. TI is not responsible or liable for any such statements.

Buyer acknowledges and agrees that it is solely responsible for compliance with all legal, regulatory and safety-related requirements concerning its products, and any use of TI components in its applications, notwithstanding any applications-related information or support that may be provided by TI. Buyer represents and agrees that it has all the necessary expertise to create and implement safeguards which anticipate dangerous consequences of failures, monitor failures and their consequences, lessen the likelihood of failures that might cause harm and take appropriate remedial actions. Buyer will fully indemnify TI and its representatives against any damages arising out of the use of any TI components in safety-critical applications.

In some cases, TI components may be promoted specifically to facilitate safety-related applications. With such components, TI's goal is to help enable customers to design and create their own end-product solutions that meet applicable functional safety standards and requirements. Nonetheless, such components are subject to these terms.

No TI components are authorized for use in FDA Class III (or similar life-critical medical equipment) unless authorized officers of the parties have executed a special agreement specifically governing such use.

Only those TI components which TI has specifically designated as military grade or "enhanced plastic" are designed and intended for use in military/aerospace applications or environments. Buyer acknowledges and agrees that any military or aerospace use of TI components which have **not** been so designated is solely at the Buyer's risk, and that Buyer is solely responsible for compliance with all legal and regulatory requirements in connection with such use.

TI has specifically designated certain components as meeting ISO/TS16949 requirements, mainly for automotive use. In any case of use of non-designated products, TI will not be responsible for any failure to meet ISO/TS16949.

Products

Audio	www.ti.com/audio
Amplifiers	amplifier.ti.com
Data Converters	dataconverter.ti.com
DLP® Products	www.dlp.com
DSP	dsp.ti.com
Clocks and Timers	www.ti.com/clocks
Interface	interface.ti.com
Logic	logic.ti.com
Power Mgmt	power.ti.com
Microcontrollers	microcontroller.ti.com
RFID	www.ti-rfid.com
OMAP Applications Processors	www.ti.com/omap
Wireless Connectivity	www.ti.com/wirelessconnectivity

Applications

Automotive and Transportation	www.ti.com/automotive
Communications and Telecom	www.ti.com/communications
Computers and Peripherals	www.ti.com/computers
Consumer Electronics	www.ti.com/consumer-apps
Energy and Lighting	www.ti.com/energy
Industrial	www.ti.com/industrial
Medical	www.ti.com/medical
Security	www.ti.com/security
Space, Avionics and Defense	www.ti.com/space-avionics-defense
Video and Imaging	www.ti.com/video

TI E2E Community

e2e.ti.com