

Current-compensated Chokes



- | Rated currents from 0.3 to 10 A
- | DC to 400 Hz frequency
- | 100 kHz to 3 MHz common-mode resonance frequency
- | Dual-choke configurations
- | Multiple PCB-mounting options



Performance indicators



Technical specifications

Operating voltage	300 VAC
Operating frequency	DC to 400 Hz
Rated currents	0.3 to 10 A @ rated ambient temperature
Rated inductance	0.4 to 100 mH
Stray inductance	Typically 1% of L_N
Inductance reduction (DC bias with IN)	Less than 10% (25°C)
High potential test voltage winding-to-winding @ 25°C	1500 VAC, 60 sec, guaranteed 1500 VAC, 2 sec, factory test
winding-to-housing @ 25°C	4000 VAC, 60 sec, guaranteed
MTBF @ 40°C/230 V (Mil-HB-217F)	>5,000,000 hours
Surge current @ 10 msec	20 x I_N @ 25°C
Temperature range (operation and storage)	-40°C to 100°C (40/100/56) acc. IEC 60068-1
Flammability corresponding to	Potting compound UL 94V-0 Housing UL 94V-0 Ringcore coating UL 94V-0
Design corresponding to	UL 1283, IEC/EN 60938-1

Approvals



ROHS

RN chokes are attenuating common-mode or asymmetric (P/N → E) interference signals, by being connected in series with the phase and neutral lines of an AC powerline input. Symmetrical components of the noise are also attenuated by the leakage inductance (stray inductance) of the windings. These chokes are typically used in conjunction with suppression capacitors.

Features and benefits

- | High saturation resistance and excellent thermal behavior
- | Through hole pin connections
- | Dual-choke configuration
- | Small compact design
- | Multiple housing options
- | Custom-specific versions are available on request
- | Higher temperature versions
- | Fully potted design usable for ruggedized applications

Typical applications

- | Switch-mode power applications
- | Suppressing common-mode interference levels
- | EMI input filters
- | For suppression-equipment with no earth connection
- | Phase-angle control circuits in combination with saturating chokes

Typical electrical schematic

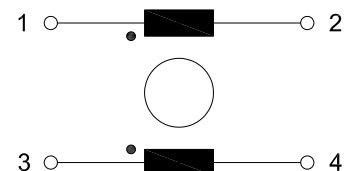

Choke selection table

Filter	Current (I_N) [A]	@ ambient temperature [°C]	Inductance (L_N) [mH]	Resistance (R_{DC}) [mOhm]	A [mm]	B [mm]	H [mm]	Weight (g)
RN 102-0.3-02-22M	0.3	40	22.0	1300	10.0	10.0	9.0	4
RN 102-0.3-02-12M	0.3	40	12.0	1100	10.0	10.0	9.0	3
RN 102-0.6-02-4M4	0.6	40	4.4	380	10.0	10.0	9.0	3
RN 102-1-02-3M0	1.0	40	3.0	210	10.0	10.0	9.0	3
RN 102-1.5-02-1M6	1.5	40	1.6	94	10.0	10.0	9.0	3
RN 102-2-02-1M1	2.0	40	1.1	70	10.0	10.0	9.0	3
RN 112-0.4-02-39M	0.4	40	39.0	1500	15.0	10.0	12.6	6
RN 112-0.4-02-27M	0.4	40	27.0	1400	15.0	10.0	12.6	6
RN 112-0.5-02-27M	0.5	40	27.0	1200	15.0	10.0	12.6	6
RN 112-0.5-02-18M	0.5	40	18.0	1100	15.0	10.0	12.6	6
RN 112-0.5-02-15M	0.5	40	15.0	700	15.0	10.0	12.6	6
RN 112-0.6-02-15M	0.6	40	15.0	490	15.0	10.0	12.6	6
RN 112-0.8-02-10M	0.8	40	10.0	380	15.0	10.0	12.6	6
RN 112-1.2-02-6M8	1.2	40	6.8	250	15.0	10.0	12.6	6
RN 112-1.5-02-3M3	1.5	40	3.3	102	15.0	10.0	12.6	6
RN 112-2-02-1M8	2.0	40	1.8	74	15.0	10.0	12.6	6
RN 112-2-02-1M0	2.0	40	1.0	70	15.0	10.0	12.6	6
RN 112-2.6-02-0M4	2.6	40	0.4	40	15.0	10.0	12.6	6
RN 112-3.6-02-0M4	3.6	40	0.4	27	15.0	10.0	12.6	6
RN 112-4-02-0M7	4.0	40	0.7	24	15.0	10.0	12.6	6
RN 114-0.3-02-47M	0.3	40	47.0	1700	20.1	12.5	13.2	10
RN 114-0.5-02-39M	0.5	40	39.0	830	20.1	12.5	13.2	11
RN 114-0.8-02-27M	0.8	40	27.0	500	20.1	12.5	13.2	11
RN 114-1-02-15M	1.0	40	15.0	370	20.1	12.5	13.2	10
RN 114-1.2-02-10M	1.2	40	10.0	195	20.1	12.5	13.2	10
RN 114-1.5-02-6M8	1.5	40	6.8	123	20.1	12.5	13.2	11
RN 114-2-02-4M2	2.0	40	4.2	100	20.1	12.5	13.2	11
RN 114-2.5-02-3M3	2.5	40	3.3	72	20.1	12.5	13.2	11
RN 114-3-02-2M0	3.0	40	2.0	52	20.1	12.5	13.2	10
RN 114-4-02-1M5	4.0	40	1.5	34	20.1	12.5	13.2	11
RN 116-0.5-02-47M	0.5	60	47.0	960	20.1	12.5	13.2	11
RN 116-0.5-02-39M	0.5	60	39.0	920	20.1	12.5	13.2	11
RN 116-0.5-02-27M	0.5	60	27.0	790	20.1	12.5	13.2	11
RN 116-0.8-02-27M	0.8	60	27.0	370	20.1	12.5	13.2	13
RN 116-1-02-15M	1.0	60	15.0	260	20.1	12.5	13.2	12
RN 116-1-02-10M	1.0	60	10.0	210	20.1	12.5	13.2	11
RN 116-1.3-02-6M8	1.3	60	6.8	140	20.1	12.5	13.2	12
RN 116-1.5-02-10M	1.5	60	10.0	148	20.1	12.5	13.2	12
RN 116-1.7-02-4M0	1.7	60	4.0	87	20.1	12.5	13.2	12
RN 116-2-02-3M3	2.0	60	3.3	70	20.1	12.5	13.2	12
RN 116-2-02-2M2	2.0	60	2.2	66	20.1	12.5	13.2	11
RN 122-0.5-02-56M	0.5	40	56.0	1800	25.0	15.0	16.5	20
RN 122-0.6-02-47M	0.6	40	47.0	1300	25.0	15.0	16.5	20
RN 122-0.8-02-39M	0.8	40	39.0	1000	25.0	15.0	16.5	20
RN 122-1-02-18M	1.0	40	18.0	630	25.0	15.0	16.5	19
RN 122-1-02-10M	1.0	40	10.0	560	25.0	15.0	16.5	19
RN 122-1.5-02-10M	1.5	40	10.0	250	25.0	15.0	16.5	20
RN 122-2-02-6M8	2.0	40	6.8	156	25.0	15.0	16.5	20
RN 122-2-02-5M0	2.0	40	5.0	140	25.0	15.0	16.5	21
RN 122-2.5-02-5M6	2.5	40	5.6	110	25.0	15.0	16.5	20
RN 122-3-02-4M5	3.0	40	4.5	80	25.0	15.0	16.5	21
RN 122-4-02-3M3	4.0	40	3.3	46	25.0	15.0	16.5	22
RN 122-4-02-1M8	4.0	40	1.8	42	25.0	15.0	16.5	22

Filter	Current (In) [A]	@ ambient temperature [°C]	Inductance (LN) [mH]	Resistance (Rdc) [mOhm]	A [mm]	B [mm]	H [mm]	Weight (g)
RN 142-0.5-02-82M	0.5	40	82.0	2700	30.0	20.0	19.7	36
RN 142-1-02-33M	1.0	40	33.0	810	30.0	20.0	19.7	37
RN 142-1.4-02-27M	1.4	40	27.0	500	30.0	20.0	19.7	40
RN 142-2-02-6M8	2.0	40	6.8	192	30.0	20.0	19.7	36
RN 142-4-02-3M3	4.0	40	3.3	67	30.0	20.0	19.7	38
RN 142-6-02-1M8	6.0	40	1.8	20	30.0	20.0	19.7	40
RN 143-0.5-02-100M	0.5	40	100.0	2900	30.0	20.0	19.7	36
RN 143-1-02-47M	1.0	40	47.0	890	30.0	20.0	19.7	38
RN 143-2-02-10M	2.0	40	10.0	240	30.0	20.0	19.7	42
RN 143-4-02-3M9	4.0	40	3.9	59	30.0	20.0	19.7	39
RN 143-6-02-1M8	6.0	40	1.8	20	30.0	20.0	19.7	42
RN 152-1-02-68M	1.0	40	68.0	1300	40.0	15.0	25.0	75
RN 152-2-02-18M	2.0	40	18.0	350	40.0	15.0	25.0	64
RN 152-4-02-6M8	4.0	40	6.8	87	40.0	15.0	25.0	74
RN 152-6-02-3M9	6.0	40	3.9	42	40.0	15.0	25.0	68
RN 152-8-02-2M7	8.0	40	2.7	22	40.0	15.0	25.0	73
RN 152-10-02-1M8	10.0	40	1.8	14	40.0	15.0	25.0	73
RN 202-0.3-02-22M	0.3	40	22.0	1300	5.1	15.2	13.5	4
RN 202-0.3-02-12M	0.3	40	12.0	1100	5.1	15.2	13.5	4
RN 202-0.6-02-4M4	0.6	40	4.4	380	5.1	15.2	13.5	4
RN 202-1-02-3M0	1.0	40	3.0	210	5.1	15.2	13.5	4
RN 202-1.5-02-1M6	1.5	40	1.6	94	5.1	15.2	13.5	4
RN 202-2-02-1M1	2.0	40	1.1	70	5.1	15.2	13.5	4
RN 204-0.3-02-22M	0.3	40	22.0	1300	7.6	10.0	14.3	3
RN 204-0.3-02-12M	0.3	40	12.0	960	7.6	10.0	14.3	3
RN 204-0.6-02-4M4	0.6	40	4.4	350	7.6	10.0	14.3	3
RN 204-1-02-3M0	1.0	40	3.0	192	7.6	10.0	14.3	3
RN 204-1.5-02-1M6	1.5	40	1.6	96	7.6	10.0	14.3	3
RN 204-2-02-1M1	2.0	40	1.1	57	7.6	10.0	14.3	3
RN 212-0.4-02-39M	0.4	40	39.0	1500	10.0	15.0	20.0	8
RN 212-0.4-02-27M	0.4	40	27.0	1400	10.0	15.0	20.0	8
RN 212-0.5-02-27M	0.5	40	27.0	1200	10.0	15.0	20.0	8
RN 212-0.5-02-18M	0.5	40	18.0	1100	10.0	15.0	20.0	8
RN 212-0.5-02-15M	0.5	40	15.0	700	10.0	15.0	20.0	8
RN 212-0.6-02-15M	0.6	40	15.0	490	10.0	15.0	20.0	8
RN 212-0.8-02-10M	0.8	40	10.0	380	10.0	15.0	20.0	8
RN 212-1.2-02-6M8	1.2	40	6.8	250	10.0	15.0	20.0	8
RN 212-1.5-02-3M3	1.5	40	3.3	102	10.0	15.0	20.0	8
RN 212-2-02-1M8	2.0	40	1.8	74	10.0	15.0	20.0	8
RN 212-2-02-1M0	2.0	40	1.0	70	10.0	15.0	20.0	8
RN 212-2.6-02-0M4	2.6	40	0.4	40	10.0	15.0	20.0	8
RN 212-3.6-02-0M4	3.6	40	0.4	27	10.0	15.0	20.0	8
RN 212-4-02-0M7	4.0	40	0.7	24	10.0	15.0	20.0	8
RN 214-0.3-02-47M	0.3	40	47.0	1700	12.5	10.0	25.0	14
RN 214-0.5-02-56M	0.5	40	56.0	1700	12.5	10.0	25.0	15
RN 214-0.5-02-39M	0.5	40	39.0	830	12.5	10.0	25.0	14
RN 214-0.8-02-27M	0.8	40	27.0	500	12.5	10.0	25.0	15
RN 214-1-02-15M	1.0	40	15.0	370	12.5	10.0	25.0	14
RN 214-1.2-02-10M	1.2	40	10.0	195	12.5	10.0	25.0	15
RN 214-1.5-02-6M8	1.5	40	6.8	123	12.5	10.0	25.0	15
RN 214-2-02-4M2	2.0	40	4.2	100	12.5	10.0	25.0	14

Filter	Current (In) [A]	@ ambient temperature [°C]	Inductance (LN) [mH]	Resistance (Rdc) [mOhm]	A [mm]	B [mm]	H [mm]	Weight (g)
RN 214-2-02-2M2	2.0	40	2.2	67	12.5	10.0	25.0	14
RN 214-2.5-02-3M3	2.5	40	3.3	72	12.5	10.0	25.0	15
RN 214-3-02-2M0	3.0	40	2.0	52	12.5	10.0	25.0	14
RN 214-4-02-1M5	4.0	40	1.5	34	12.5	10.0	25.0	15
RN 216-0.5-02-47M	0.5	60	47.0	960	12.5	10.0	25.0	15
RN 216-0.5-02-39M	0.5	60	39.0	920	12.5	10.0	25.0	15
RN 216-0.5-02-27M	0.5	60	27.0	790	12.5	10.0	25.0	15
RN 216-0.8-02-27M	0.8	60	27.0	370	12.5	10.0	25.0	16
RN 216-1-02-15M	1.0	60	15.0	260	12.5	10.0	25.0	16
RN 216-1-02-10M	1.0	60	10.0	210	12.5	10.0	25.0	15
RN 216-1.3-02-6M8	1.3	60	6.8	140	12.5	10.0	25.0	16
RN 216-1.5-02-10M	1.5	60	10.0	148	12.5	10.0	25.0	16
RN 216-1.7-02-4M0	1.7	60	4.0	87	12.5	10.0	25.0	16
RN 216-2-02-3M3	2.0	60	3.3	70	12.5	10.0	25.0	16
RN 216-2-02-2M2	2.0	60	2.2	66	12.5	10.0	25.0	15
RN 218-0.4-02-100M	0.4	40	100	2800	10.0	12.5	20.0	8
RN 218-0.6-02-47M	0.6	40	47.0	1200	10.0	12.5	20.0	8
RN 218-0.7-02-39M	0.7	40	39.0	1150	10.0	12.5	20.0	8
RN 218-0.9-02-27M	0.9	40	27.0	620	10.0	12.5	20.0	8
RN 218-1-02-22M	1.0	40	22.0	520	10.0	12.5	20.0	8
RN 218-1.1-02-15M	1.1	40	15.0	420	10.0	12.5	20.0	8
RN 218-1.4-02-10M	1.4	40	10.0	330	10.0	12.5	20.0	8
RN 218-1.7-02-6M8	1.7	40	6.8	180	10.0	12.5	20.0	8
RN 218-2.2-02-3M3	2.2	40	3.3	100	10.0	12.5	20.0	8
RN 222-0.5-02-56M	0.5	40	56.0	1800	15.0	12.5	29.3	27
RN 222-0.6-02-47M	0.6	40	47.0	1300	15.0	12.5	29.3	26
RN 222-0.8-02-39M	0.8	40	39.0	1000	15.0	12.5	29.3	27
RN 222-1-02-33M	1.0	40	33.0	1300	15.0	12.5	29.3	29
RN 222-1-02-18M	1.0	40	18.0	630	15.0	12.5	29.3	26
RN 222-1.5-02-10M	1.5	40	10.0	250	15.0	12.5	29.3	26
RN 222-2-02-6M8	2.0	40	6.8	156	15.0	12.5	29.3	28
RN 222-2.5-02-5M6	2.5	40	5.6	110	15.0	12.5	29.3	27
RN 222-3-02-4M5	3.0	40	4.5	80	15.0	12.5	29.3	28
RN 222-4-02-3M3	4.0	40	3.3	46	15.0	12.5	29.3	28
RN 232-0.6-02-47M	0.6	40	47.0	1300	15.0	12.5	29.3	37
RN 232-1-02-18M	1.0	40	18.0	390	15.0	12.5	29.3	38
RN 232-1.6-02-10M	1.6	40	10.0	170	15.0	12.5	29.3	38
RN 232-2.5-02-5M6	2.5	40	5.6	86	15.0	12.5	29.3	38
RN 232-4-02-3M3	4.0	40	3.3	54	15.0	12.5	29.3	38
RN 242-0.5-02-82M	0.5	40	82.0	2700	15.0	12.5	34.3	37
RN 242-1-02-33M	1.0	40	33.0	810	15.0	12.5	34.3	38
RN 242-1.4-02-27M	1.4	40	27.0	500	15.0	12.5	34.3	38
RN 242-2-02-6M8	2.0	40	6.8	192	15.0	12.5	34.3	37
RN 242-4-02-3M3	4.0	40	3.3	67	15.0	12.5	34.3	38
RN 242-6-02-1M8	6.0	40	1.8	20	15.0	12.5	34.3	41

Test conditions: Measuring frequency: 10 kHz; 50 mV; Inductance tolerance: +50%, -30%; Resistance tolerance: ±15% @ 25°C; Electrical characteristics @ 25°C: ±2°C;
 Stray Inductance measurement between pin 1 and 2 (pin 3 and 4 shorted)
 For mechanical tolerances refer to mechanical data section.

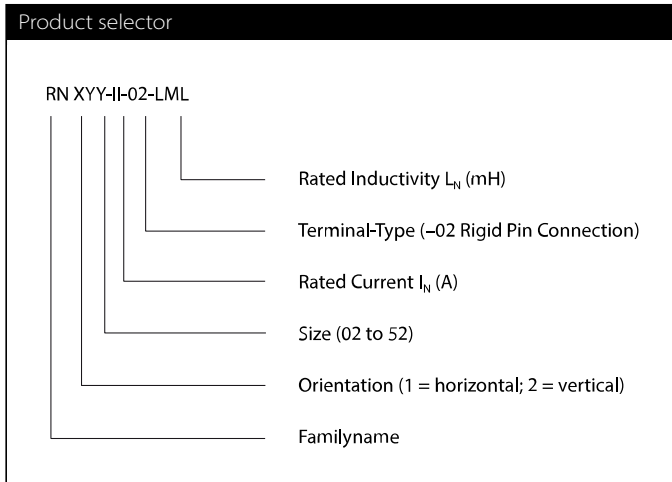

Thermal Derating

If higher ambient temperatures than the specified apply, the nominal current needs to be reduced according to the graph below.

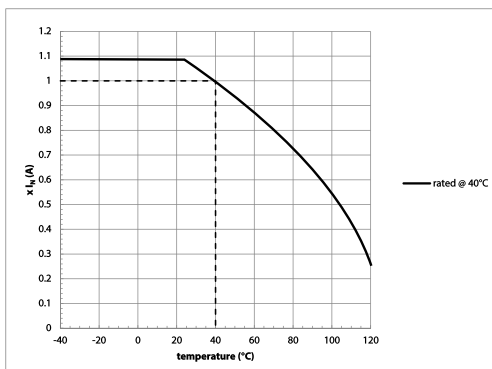

Typical attenuation/resonance frequency characteristics

Per CISPR 17; 50 Ω/50 Ω asym

X can be exchanged with either 1 or 2 for different housing configuration, attenuation is similar

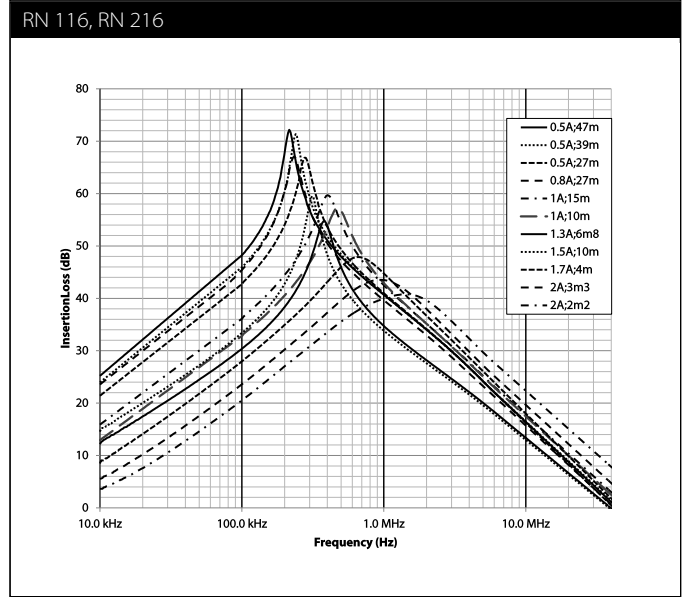
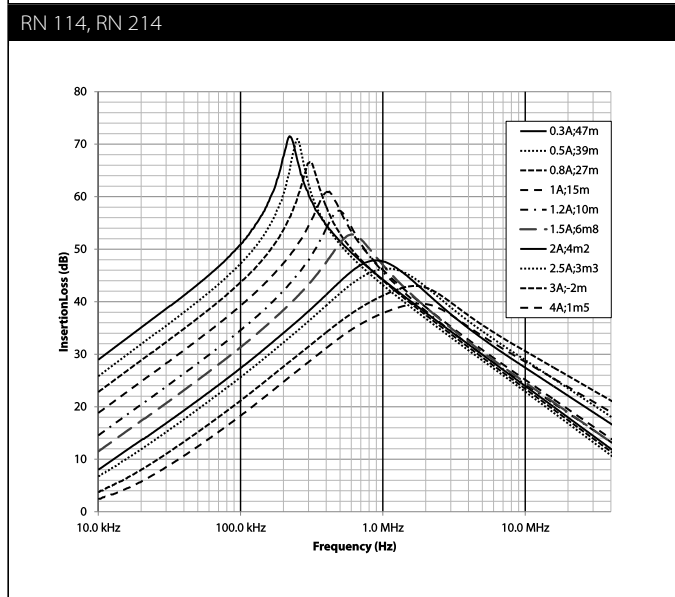
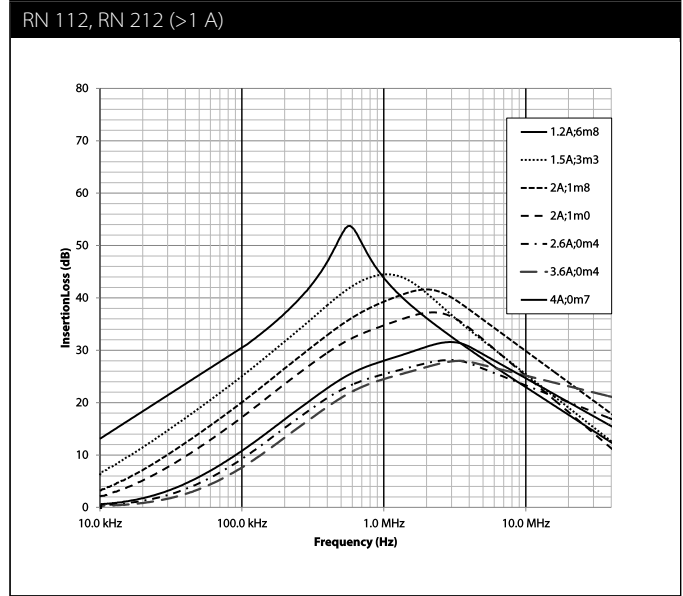
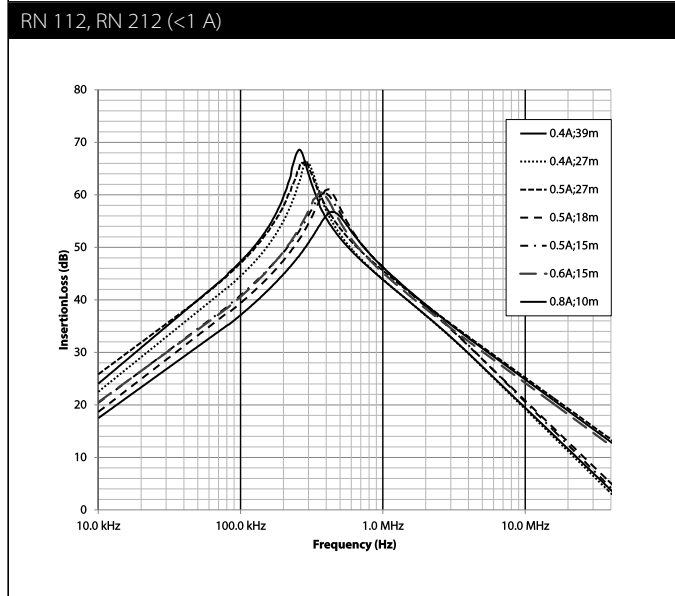
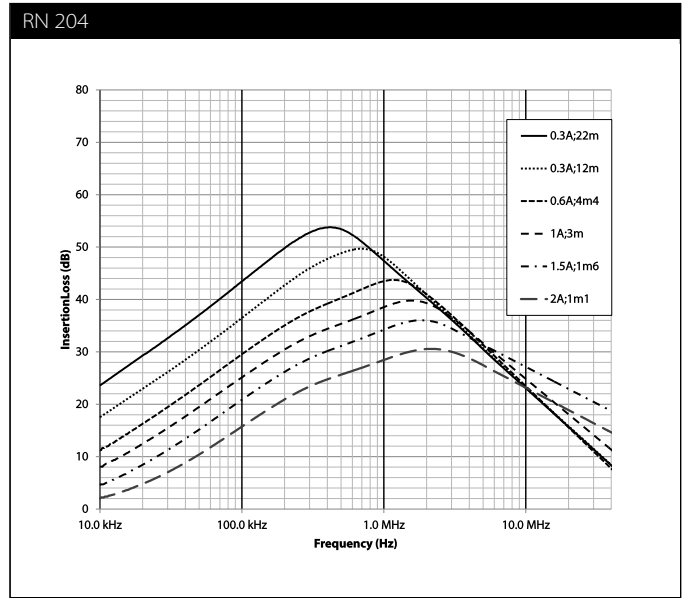
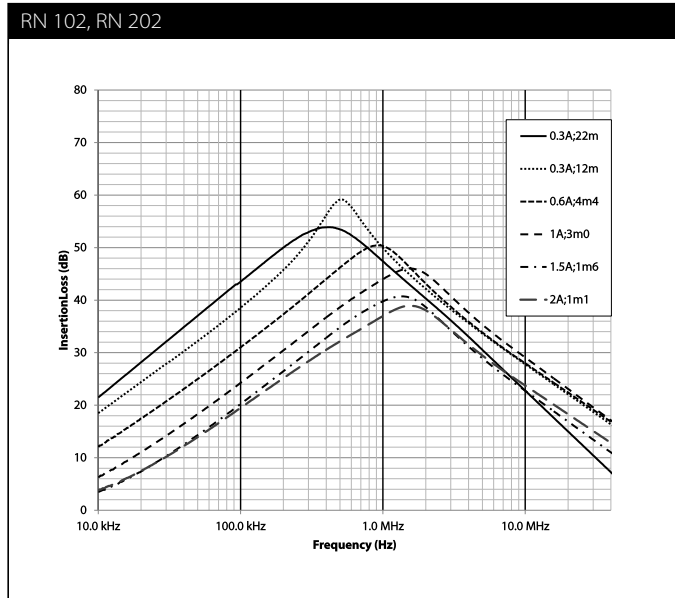

RN 218

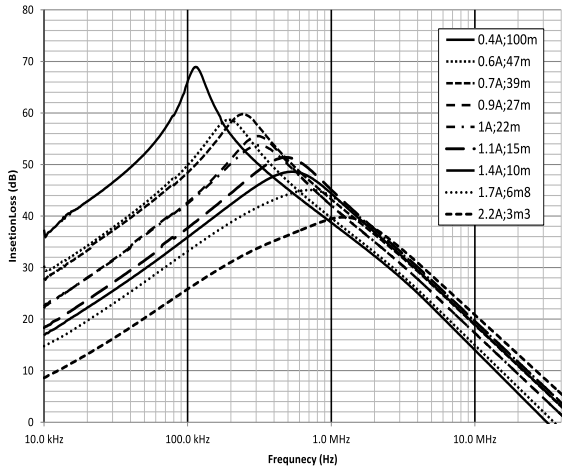

RN 122, RN 222

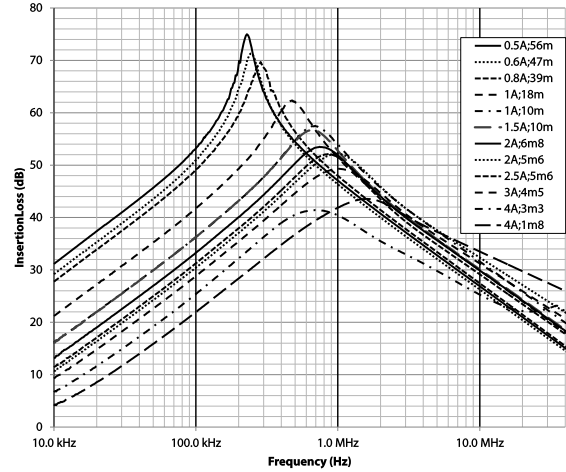

RN 232

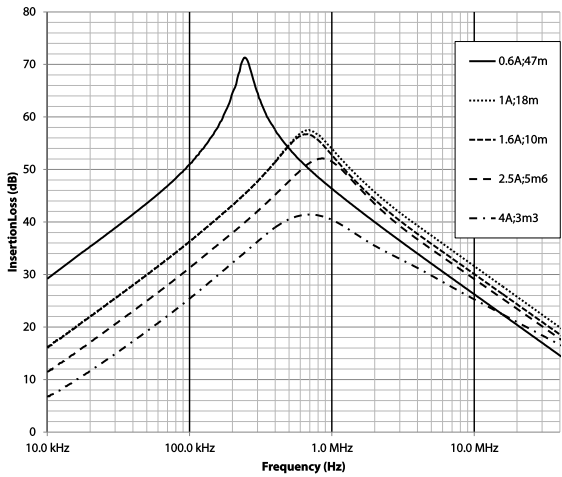

RN 142, RN 242

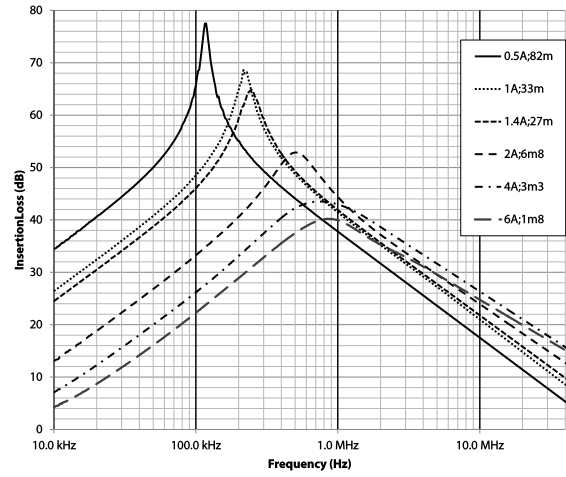

RN 143

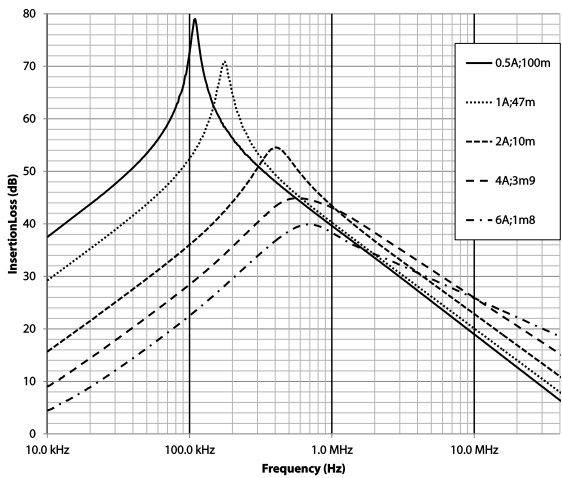

RN 152

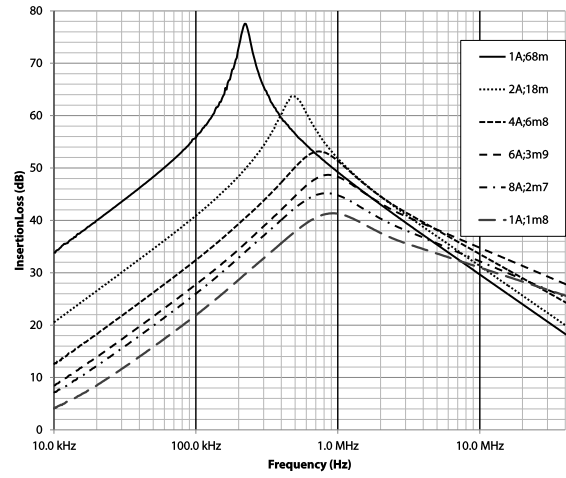

Mechanical data

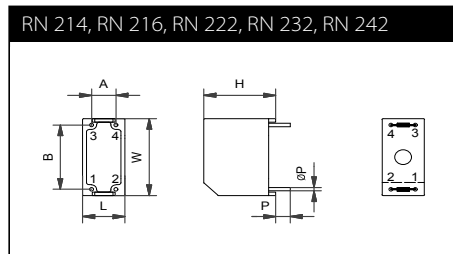
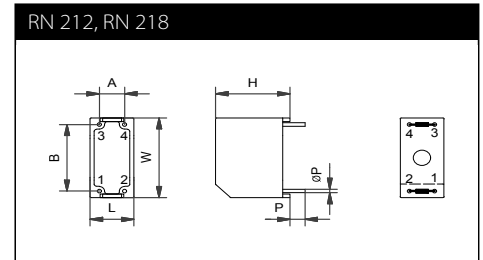
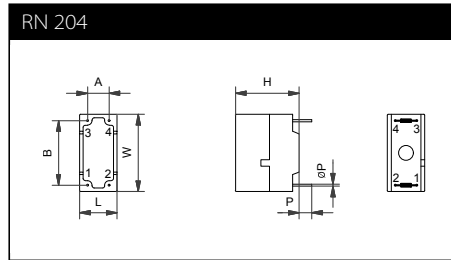
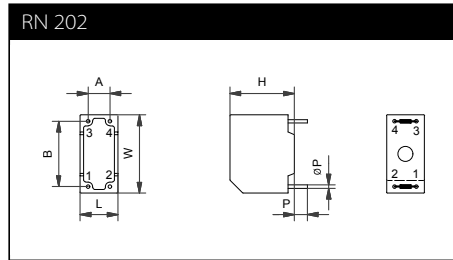
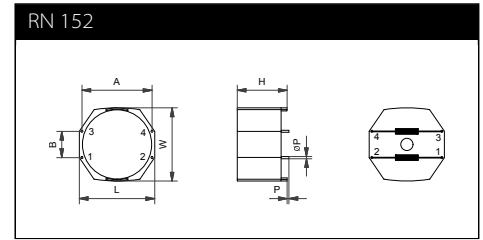
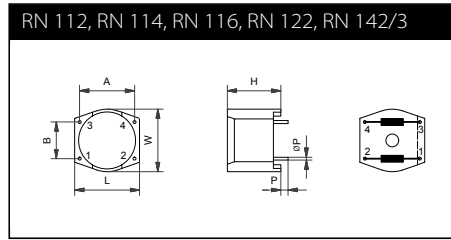
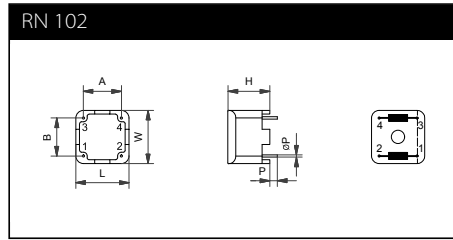

Pin material: Steel (base), Cu (under plating), Sn (final plating 6µm)

Dimensions

	A (±0.6 mm)	B (±0.6 mm)	H (±0.3 mm)	L (±0.3 mm)	W (±0.3 mm)	P (±0.5 mm)	ØP (±0.1 mm)
RN 102	10.0 mm	10.0 mm	9.0 mm	14.0 mm	14.0 mm	4.0 mm	0.6 mm
RN 112	15.0 mm	10.0 mm	12.6 mm	17.7 mm	17.1 mm	4.0 mm	0.8 mm
RN 114	20.1 mm	12.5 mm	13.2 mm	22.5 mm	21.5 mm	4.0 mm	0.8 mm
RN 116	20.1 mm	12.5 mm	13.2 mm	22.5 mm	21.5 mm	4.0 mm	0.8 mm
RN 122	25.0 mm	15.0 mm	16.5 mm	28.0 mm	27.0 mm	4.0 mm	0.8 mm
RN 142	30.0 mm	20.0 mm	19.7 mm	33.1 mm	32.5 mm	4.3 mm	0.8 mm
RN 143	30.0 mm	20.0 mm	19.7 mm	33.1 mm	32.5 mm	4.3 mm	0.8 mm
RN 152	40.0 mm	15.0 mm	25.0 mm	43.0 mm	41.8 mm	4.5 mm	1.2 mm
RN 202	5.1 mm	15.2 mm	13.5 mm	8.8 mm	18.2 mm	4.5 mm	0.8 mm
RN 204	7.6 mm	10.0 mm	14.3 mm	9.0 mm	14.0 mm	4.0 mm	0.5 mm
RN 212	10.0 mm	15.0 mm	20.0 mm	12.5 mm	18.0 mm	4.0 mm	0.8 mm
RN 214	12.5 mm	10.0 mm	25.0 mm	15.5 mm	23.0 mm	4.0 mm	0.8 mm
RN 216	12.5 mm	10.0 mm	25.0 mm	15.5 mm	23.0 mm	4.0 mm	0.8 mm
RN 218	10.0 mm	12.5 mm	20.0 mm	12.5 mm	18.0 mm	4.0 mm	0.8 mm
RN 222	15.0 mm	12.5 mm	29.3 mm	18.0 mm	31.0 mm	4.0 mm	0.8 mm
RN 232	15.0 mm	12.5 mm	34.3 mm	18.0 mm	31.0 mm	4.2 mm	0.8 mm
RN 242	15.0 mm	12.5 mm	34.3 mm	18.0 mm	31.0 mm	4.2 mm	0.8 mm

Please visit www.schaffner.com to find more details on filter connections.



Headquarters, global innovation and development

Switzerland

Schaffner Group

Nordstrasse 11
4542 Luterbach
T +41 32 681 66 26
info@schaffner.com
www.schaffner.com



Sales and application centers

China

Schaffner EMC Ltd. Shanghai

T20-3 C, No 565 Chuangye Road,
Pudong district
201201 Shanghai
T +86 21 3813 9500
cschina@schaffner.com
www.schaffner.com.cn

Finland

Schaffner Oy

Sauvonrinne 19 H
08500 Lohja
T +358 50 468 7284
finlandsales@schaffner.com

France

Schaffner EMC S.A.S.

16-20 Rue Louis Rameau
95875 Bezons
T +33 1 34 34 30 60
F +33 1 39 47 02 28
francesales@schaffner.com

Germany

Schaffner Deutschland GmbH

Schoemperlenstrasse 12B
76185 Karlsruhe
T +49 721 56910
F +49 721 569110
germanysales@schaffner.com

India

Schaffner India Pvt. Ltd

REGUS WORLD TRADE CENTRE
WTC, 22nd Floor Unit No 2238, Brigade
Gateway Campus, 26/1, Dr. Rajkumar Road
Malleswaram (W)
560055 Bangalore
T +91 80 67935355
indiasales@schaffner.com

Italy

Schaffner EMC S.r.l.

Via Ticino, 30
20900 Monza (MB)
T +39 039 21 41 070
italysales@schaffner.com

Japan

Schaffner EMC K.K.

1-32-12, Kamiyama, Setagaya-ku
7F Mitsui-seimei Sangenjaya Bldg.
154-0011 Tokyo
T +81 3 5712 3650
F +81 3 5712 3651
japansales@schaffner.com
www.schaffner.jp

Singapore

Schaffner EMC Pte Ltd.

#05-09, Kg Ubi Ind. Estate
408705 Singapore
T +65 6377 3283
F +65 6377 3281
singaporesales@schaffner.com

Spain

Schaffner EMC España

Calle Caléndula 93, Miniparc III, Edificio E
El Soto de Moraleja, Alcobendas
28109 Madrid
T +34 917 912 900
F +34 917 912 901
spainsales@schaffner.com

Sweden

Schaffner EMC AB

Tegeluddsvägen 76, 2tr
115 28 Stockholm
T +46 8 5050 2425
swedensales@schaffner.com
www.schaffner.com

Switzerland

Schaffner EMV AG

Nordstrasse 11
4542 Luterbach
T +41 32 681 66 26
switzerlandsales@schaffner.com

Taiwan R.O.C.

Schaffner EMV Ltd.

20 Floor-2, No 97, Section 1, XinTai 5th Road
22175 XiZhi District New Taipei City 22175
T +886 2 2697 5500
F +886 2 2697 5533
taiwansales@schaffner.com
www.schaffner.com.tw

Thailand

Schaffner EMC Co. Ltd.

Northern Region Industrial Estate
67 Moo 4 Tambon Ban Klang
Amphur Muangng P.O. Box 14
51000 Lamphun
T +66 53 58 11 04
F +66 53 58 10 19
thailandsales@schaffner.com

United Kingdom

Schaffner Ltd.

5 Ashville Way, Molly Millars Lane
Wokingham
RG41 2PL Berkshire
T +44 118 9770070
F +44 118 9792969
uksales@schaffner.com

USA

Schaffner EMC Inc.

52 Mayfield Avenue
08837 Edison, New Jersey
T +1 800 367 5566
T +1 732 225 9533
F +1 732 225 4789
usasales@schaffner.com
www.schaffnerusa.com

Schaffner North America

6722 Thirlane Road
24019 Roanoke, Virginia
T +1 276 228 7943
F +1 276 228 7953

Schaffner North America

823 Fairview Road
24382 Wytheville, Virginia
T +1 276 228 7943
F +1 276 228 7258

To find your local partner within Schaffner's global network: www.schaffner.com

© 2018 Schaffner Group

The content of this document has been carefully checked and understood. However, neither Schaffner nor its subsidiaries assume any liability whatsoever for any errors or inaccuracies of this document and the consequences thereof. Published specifications are subject to change without notice. Product suitability for any area of application must ultimately be determined by the customer. In all cases, products must never be operated outside their published specifications. Schaffner does not guarantee the availability of all published products. This disclaimer shall be governed by substantive Swiss law and resulting disputes shall be settled by the courts at the place of business of Schaffner Holding AG. Latest publications and a complete disclaimer can be downloaded from the Schaffner website. All trademarks recognized.