

Subminiature Relay (16 x 9.9 x 8.4 mm (L x W x H)) with DPDT Contact

- Unique moving-loop armature reduces relay size, magnetic interference and contact bounce time.
- Miniature permissible load: 0.01 mA 10 mVDC.
- Bifurcated gold-clad crossbar contact.
- International 2.54-mm terminal pitch.
- Special models available for FCC Part 68 compliance.



RoHS Compliant Refer to pages 16 to 17 for details.



Ordering Information

Classification		Single-side stable	Single-winding latching	Double-winding latching
DPDT	Fully sealed	G5A-234P	G5AU-234P	G5AK-234P

Note: When ordering, add the rated coil voltage to the model number.
Example: G5A-234P 12 VDC

Rated coil voltage

Model Number Legend

G5A □ - □ □ □ □ - □ □ VDC
1 2 3 4 5 6 7

1. Relay Function

None: Single-side stable
U: Single-winding latching
K: Double-winding latching

2. Contact Form

2: DPDT

3. Contact Type

3: Bifurcated crossbar Ag (Au-Alloy)

4. Enclosure Ratings

4: Fully sealed

5. Terminals

P: Straight PCB
C: Self-clinching PCB

6. Special Function

None: General-purpose
FC: FCC part 68 compliance
U: For ultrasonically cleanable

7. Rated Coil Voltage

3, 5, 6, 9, 12, 24, 48 VDC

Specifications

Coil Ratings

Single-side Stable Types

Rated voltage	3 VDC	5 VDC	6 VDC	9 VDC	12 VDC	24 VDC	48 VDC
Rated current	66.7 mA	40 mA	33.3 mA	22.2 mA	16.7 mA	8.3 mA	5.8 mA
Coil resistance	45 Ω	125 Ω	180 Ω	405 Ω	720 Ω	2,880 Ω	8,230 Ω
Coil inductance (H) (ref. value)	Armature OFF	0.048	0.13	0.17	0.43	0.71	2.76
	Armature ON	0.043	0.12	0.16	0.4	0.68	2.70
Must operate voltage	70% max. of rated voltage						
Must release voltage	10% min. of rated voltage						
Max. voltage	200% of rated voltage at 23°C						170% of rated voltage at 23°C
Power consumption	Approx. 200 mW						Approx. 280 mW

- Note:**
1. The rated current and coil resistance are measured at a coil temperature of 23°C with a tolerance of ±10%.
 2. Operating characteristics are measured at a coil temperature of 23°C.
 3. The maximum voltage is the highest voltage that can be imposed on the relay coil.

Single/Double-winding Latching Types

Rated voltage	3 VDC	5 VDC	6 VDC	9 VDC	12 VDC	24 VDC
Rated current	66.7 mA	40 mA	33.3 mA	22.2 mA	16.7 mA	8.3 mA
Coil resistance	45 Ω	125 Ω	180 Ω	405 Ω	720 Ω	2,880 Ω
Coil inductance (H) (ref. value)	Armature OFF	0.02	0.06	0.08	0.17	1.1
	Armature ON	0.02	0.05	0.07	0.14	0.85
Must operate voltage	80% max. of rated voltage					
Must release voltage	80% min. of rated voltage					
Max. voltage	200% of rated voltage at 23°C					
Power consumption	Approx. 200 mW					

- Note:**
1. The rated current and coil resistance are measured at a coil temperature of 23°C with a tolerance of ±10%.
 2. Operating characteristics are measured at a coil temperature of 23°C.
 3. The maximum voltage is the highest voltage that can be imposed on the relay coil.

■ Contact Ratings

Load	Resistive load ($\cos\phi = 1$)	Inductive load ($\cos\phi = 0.4$) (L/R = 7 ms)
Rated load	0.5 A at 30 VAC; 1 A at 30 VDC	0.1 A at 30 VAC; 0.2 A at 30 VDC
Contact material	Ag (Au-Alloy)	
Rated carry current	1 A	
Max. switching voltage	125 VAC, 125 VDC	
Max. switching current	1 A	0.5 A
Max. switching power	37.5 VA, 33 W	12.5 VA, 11 W
Failure rate (reference value) (See note.)	0.01 mA at 10 mVDC	

Note: P level: $\lambda_{60} = 0.1 \times 10^{-6}$ /operation

This value was measured at a switching frequency of 120 operations/min and the criterion of contact resistance is 100 Ω. This value may vary depending on the switching frequency and operating environment. Always double-check relay suitability under actual operating conditions.

■ Characteristics

Contact resistance (See note 1.)	50 mΩ max.
Operate (set) time (See note 2.)	Single-side stable types: 5 ms max. (approx. 2.4 ms) Latching types: 5 ms max. (approx. 2 ms)
Release (reset) time (See note 2.)	Single-side stable types: 5 ms max. (approx. 1.1 ms) Latching types: 5 ms max. (approx. 1.8 ms)
Min. set/reset signal width	Latching type: 7 ms
Max. operating frequency	Mechanical: 36,000 operations/hr Electrical: 1,800 operations/hr (under rated load)
Insulation resistance (See note 3.)	1,000 MΩ min. (at 250 VDC)
Dielectric strength	1,000 VAC, 50/60 Hz for 1 min between coil and contacts (See note 4.) 1,000 VAC, 50/60 Hz for 1 min between contacts of different polarity (See note 4.) 500 VAC, 50/60 Hz for 1 min between contacts of same polarity (See note 5.) 100 VAC, 50/60 Hz for 1 min between set and reset coils (double-winding type only)
Impulse withstand voltage	1,500 V (10 x 160 μs) between contacts of same polarity (conforms to FCC Part 68)
Vibration resistance	Destruction: 10 to 55 to 10 Hz, 0.75-mm single amplitude (1.5-mm double amplitude) Malfunction: 10 to 55 to 10 Hz, 0.75-mm single amplitude (1.5-mm double amplitude)
Shock resistance	Destruction: 1,000 m/s ² (approx. 100G) Malfunction: 300 m/s ² (approx. 30G)
Endurance	Mechanical: 50,000,000 operations min. (at 36,000 operations/hr) Electrical: 100,000 operations min. (at 1,800 operations/hr)
Ambient temperature	Operating: -40°C to 70°C (with no icing)
Ambient humidity	Operating: 5% to 85%
Weight	Approx. 3 g

Note: The above values are initial values.

- Note:**
1. The contact resistance was measured with 10 mA at 1 VDC with a voltage drop method.
 2. Values in parentheses are actual values.
 3. The insulation resistance was measured with a 250-VDC megohmmeter applied to the same parts as those used for checking the dielectric strength (except between the set and reset coil).
 4. Models with FC suffix: 1,200 VAC, 50/60 Hz for 1 min, impulse withstand voltage of 1,500 V (10 x 160 μs).
 5. Models with FC suffix: 750 VAC, 50/60 Hz for 1 min, impulse withstand voltage of 1,500 V (10 x 160 μs).

Engineering Data

Maximum Switching Power

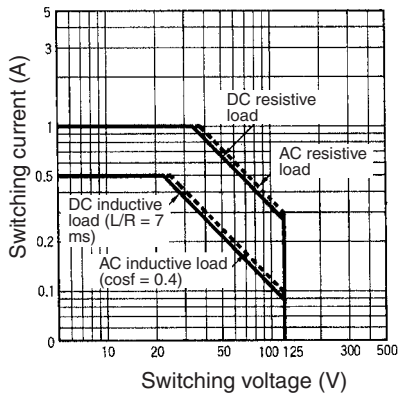

Endurance

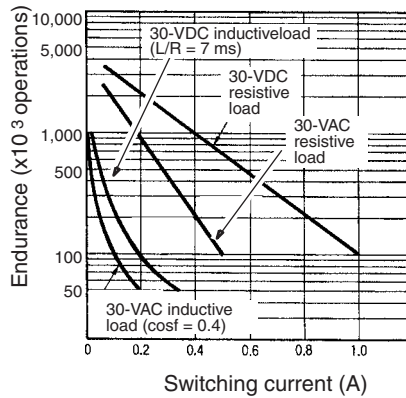

Ambient Temperature vs. Maximum Coil Voltage

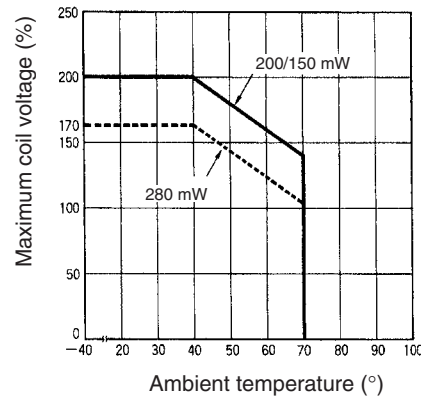

Note: The maximum coil voltage refers to the maximum value in a varying range of operating power voltage, not a continuous voltage.

■ Approved Standards

UL114, UL478 (File No.E41515)/CSA C22.2 No.0, No.14 (File No.LR31928)

Model	Contact form	Coil ratings	Contact ratings
G5A-234P	DPDT	3 to 48 VDC	0.5 A, 60 VAC 0.5 A, 60 VDC 1 A, 30 VDC
G5AU-234P		3 to 24 VDC	
G5AK-234P			

Dimensions

Note: 1. All units are in millimeters unless otherwise indicated.

2. Orientation marks are indicated as follows:  

G5A-234P

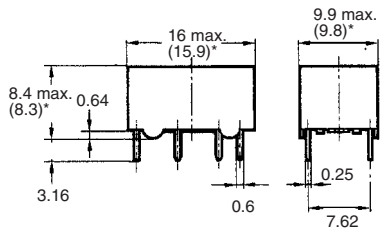
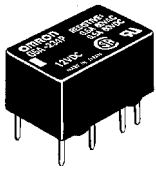

*Average value

Terminal Arrangement/ Internal Connections (Bottom View)

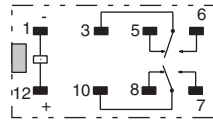

Mounting Holes (Bottom View)

Tolerance: ± 0.1

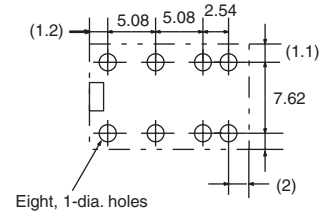

G5AU-234P

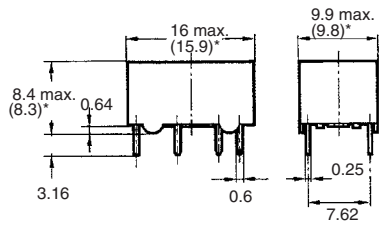
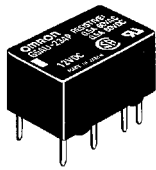

*Average value

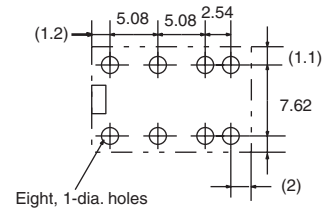
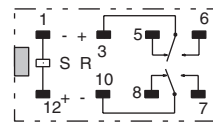

G5AK-234P

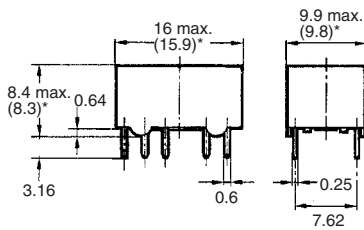
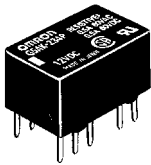

*Average value

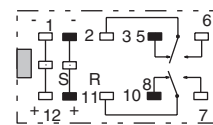

S: Set coil
R: Reset coil

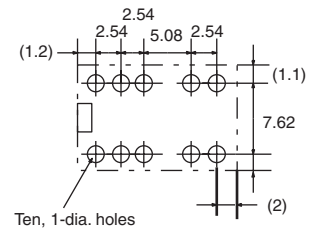

Precautions

Long-term Continuously ON Contacts

Using the Relay in a circuit where the Relay will be ON continuously for long periods (without switching) can lead to unstable contacts because the heat generated by the coil itself will affect the insulation, causing a film to develop on the contact surfaces. We recommend using a latching relay (magnetic-holding relay) in this kind of circuit. If a single-side stable model must be used in this kind of circuit, we recommend using a fail-safe circuit design that provides protection against contact failure or coil burnout.

Relay Handling

When washing the product after soldering the Relay to a PCB, use a water-based solvent or alcohol-based solvent, and keep the solvent temperature to less than 40°C. Do not put the Relay in a cold cleaning bath immediately after soldering.

ALL DIMENSIONS SHOWN ARE IN MILLIMETERS.

To convert millimeters into inches, multiply by 0.03937. To convert grams into ounces, multiply by 0.03527.