

# PQ30RV1/PQ30RV11/PQ30RV2/PQ30RV21

Variable Output Low Power-Loss Voltage Regulators

## Features

- Compact resin full-mold package
- Low power-loss (Dropout voltage: MAX.0.5V)
- Variable output voltage(setting range: 1.5 to 30V)
- Built-in output ON/OFF control function

## Applications

- Power supply for print concentration control of electronic typewriters with display
- Series power supply for motor drives
- Series power supply for VCRs and TVs

## Model Line-ups

Output voltage precision	1A output	2A output
Reference voltage precision:±4%	PQ30RV1	PQ30RV2
Reference voltage precision:±2%	PQ30RV11	PQ30RV21

## Outline Dimensions

(Unit : mm)

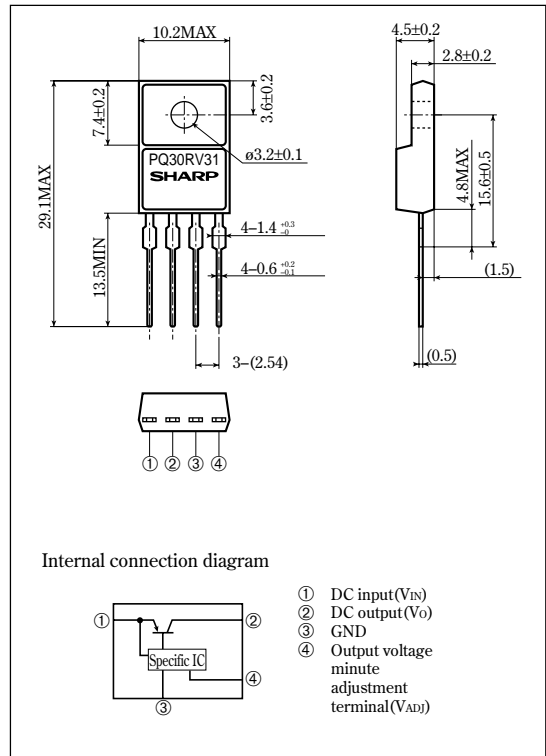

## Equivalent Circuit Diagram

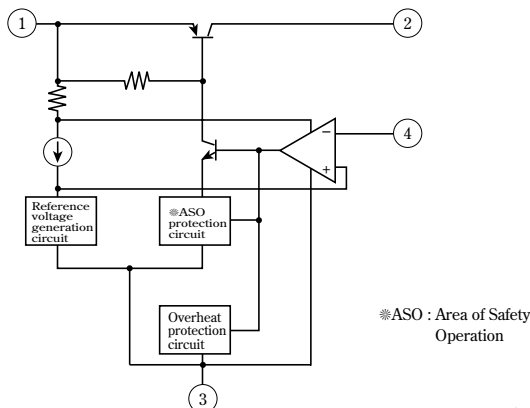

•Please refer to the chapter " Handling Precautions ".

**SHARP**

**Absolute Maximum Ratings**

(T<sub>a</sub>=25°C)

Parameter	Symbol	Rating	Unit
*#1 Input voltage	V <sub>IN</sub>	35	V
*#1 Output voltage adjustment voltage	V <sub>ADJ</sub>	7	V
Output current	I <sub>o</sub>	PQ30RV1/PQ30RV11	1
		PQ30RV2/PQ30RV21	2
Power dissipation(No heat sink)	P <sub>D1</sub>	1.5	W
Power dissipation (With infinite heat sink)	P <sub>D2</sub>	PQ30RV1/PQ30RV11	15
		PQ30RV2/PQ30RV21	18
*#2 Junction temperature	T <sub>j</sub>	150	°C
Operating temperature	T <sub>opr</sub>	-20 to +80	°C
Storage temperature	T <sub>stg</sub>	-40 to +150	°C
Soldering temperature	T <sub>sol</sub>	260(For 10s)	°C

\*#1 All are open except GND and applicable terminals.

\*#2 Overheat protection may operate at T<sub>j</sub>≥125°C.

**Electrical Characteristics**

Unless otherwise specified, condition shall be  
 V<sub>IN</sub>=15V, V<sub>O</sub>=10V, I<sub>O</sub>=0.5A, R<sub>1</sub>=390Ω(PQ30RV1/PQ30RV11)  
 V<sub>IN</sub>=15V, V<sub>O</sub>=10V, I<sub>O</sub>=1.0A, R<sub>1</sub>=390Ω(PQ30RV2/PQ30RV21)

(T<sub>a</sub>=25°C)

Parameter	Symbol	Conditions	MIN.	TYP.	MAX.	Unit	
Input voltage	V <sub>IN</sub>	-	4.5	-	35	V	
Output voltage	V <sub>o</sub>	R <sub>2</sub> =94Ω to 8.5kΩ	1.5	-	30	V	
		R <sub>2</sub> =84Ω to 8.7kΩ					
Load regulation	RegL	I <sub>O</sub> =5mA to 1A	-	0.3	1.0	%	
		I <sub>O</sub> =5mA to 2A	-	0.5	1.0		
Line regulation	RegI	V <sub>IN</sub> =11 to 28V	-	0.5	2.5	%	
Ripple rejection	RR	C <sub>ref</sub> =0	Refer to Fig. 2	45	55	-	dB
		C <sub>ref</sub> =3.3μF		55	65	-	
Reference voltage	V <sub>ref</sub>	-	1.20	1.25	1.30	V	
			1.225	1.25	1.275		
Temperature coefficient of reference voltage	TcV <sub>ref</sub>	T <sub>j</sub> =0 to 125°C	-	±1.0	-	%	
Dropout voltage	V <sub>i-O</sub>	*#3, I <sub>O</sub> =0.5A	-	-	0.5	V	
		*#3, I <sub>O</sub> =2A					
Quiescent current	I <sub>q</sub>	I <sub>O</sub> =0	-	-	7	mA	

\*#3 Input voltage shall be the value when output voltage is 95% in comparison with the initial value.

**Fig. 1 Test Circuit**

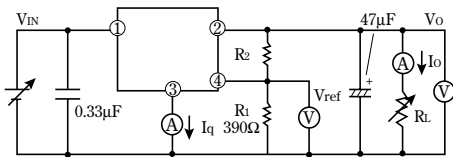

$$V_o = V_{ref} \times \left( 1 + \frac{R_2}{R_1} \right)$$

[R<sub>1</sub>=390Ω, V<sub>ref</sub> Nearly=1.25V]

**Fig. 2 Test Circuit of Ripple Rejection**

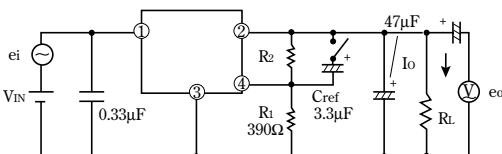

I<sub>O</sub>=0.5A  
 f=120Hz(sine wave)  
 e<sub>i</sub>(rms)=0.5V  
 RR=20 log(e<sub>i</sub>(rms)/e<sub>o</sub>(rms))

**Fig. 3 Power Dissipation vs. Ambient Temperature (PQ30RV1/PQ30RV11)**

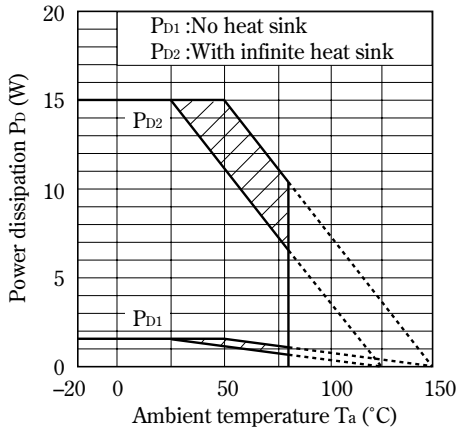

Note) Oblique line portion : Overheat protection may operate in this area.

**Fig. 4 Power Dissipation vs. Ambient Temperature (PQ30RV2/PQ30RV21)**

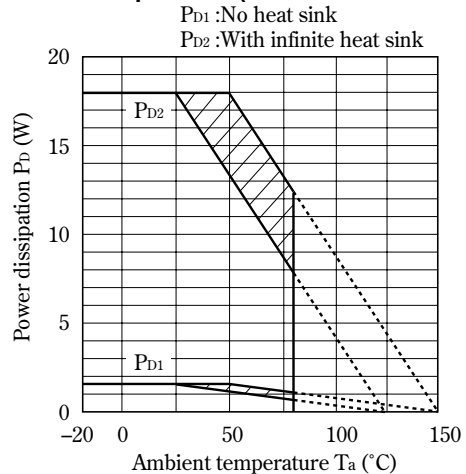

Note) Oblique line portion : Overheat protection may operate in this area.

**Fig. 5 Overcurrent Protection Characteristics (PQ30RV1/PQ30RV11)**

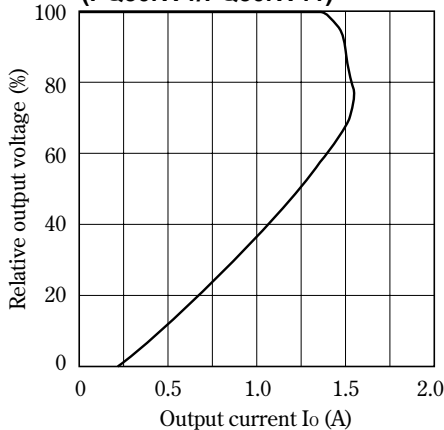

**Fig. 6 Overcurrent Protection Characteristics (PQ30RV2/PQ30RV21)**

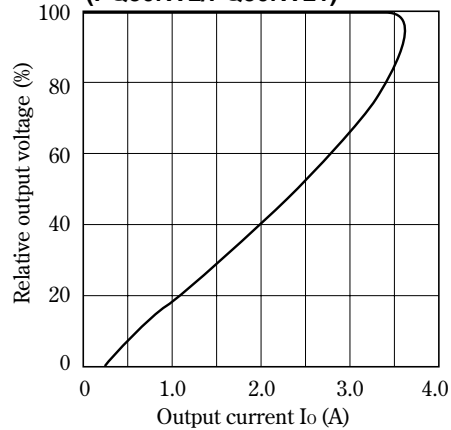

**Fig. 7 Output Voltage Adjustment Characteristics**

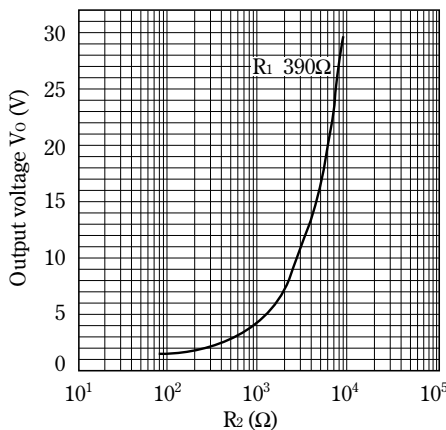

**Fig. 8 Reference Voltage Deviation vs. Junction Temperature**

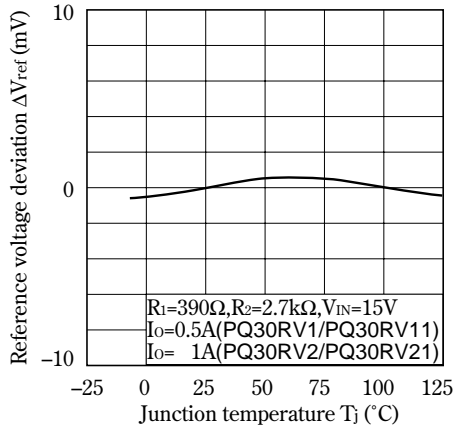

**Fig. 9 Output Voltage vs. Input Voltage (PQ30RV1/PQ30RV11)**

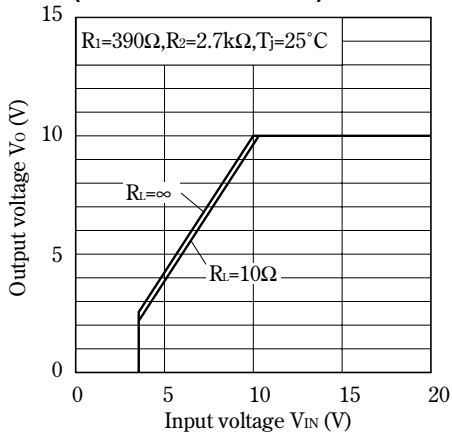

**Fig.10 Output Voltage vs. Input Voltage (PQ30RV2/PQ30RV21)**

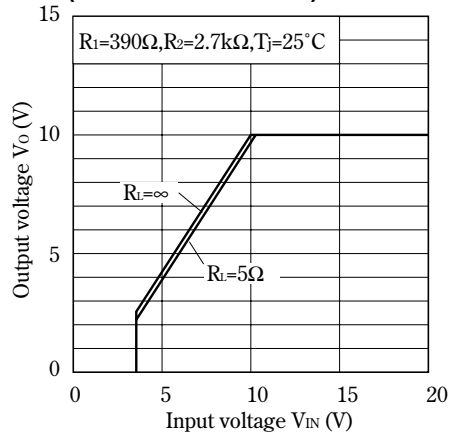

**Fig.11 Dropout Voltage vs. Junction Temperature (PQ30RV1/PQ30RV11)**

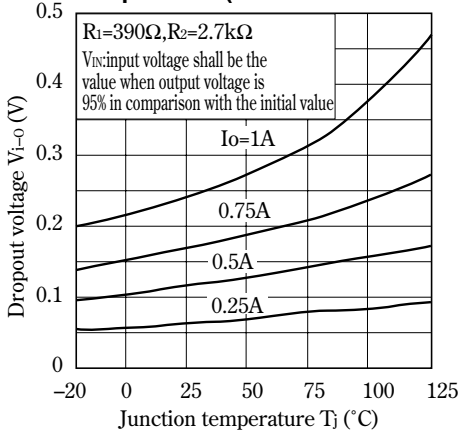

**Fig.12 Dropout Voltage vs. Junction Temperature (PQ30RV2/PQ30RV21)**

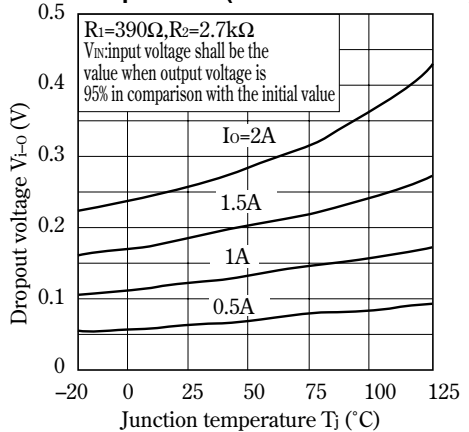

**Fig.13 Quiescent Current vs. Junction Temperature**

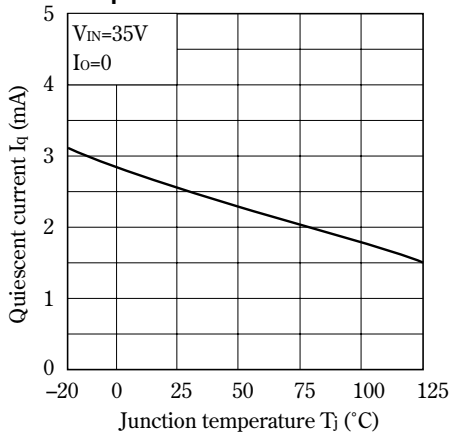

**Fig.14 Ripple Rejection vs. Input Ripple Frequency (PQ30RV1/PQ30RV11)**

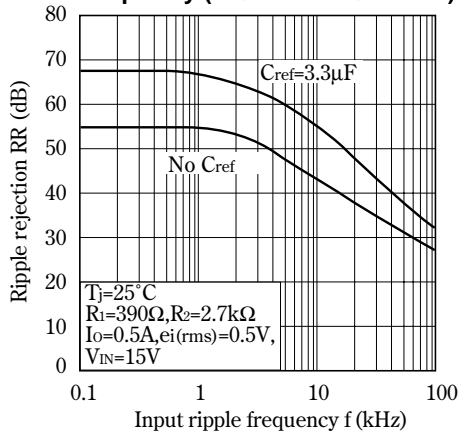

**Fig.15 Ripple Rejection vs. Input Ripple Frequency (PQ30RV2/PQ30RV21)**

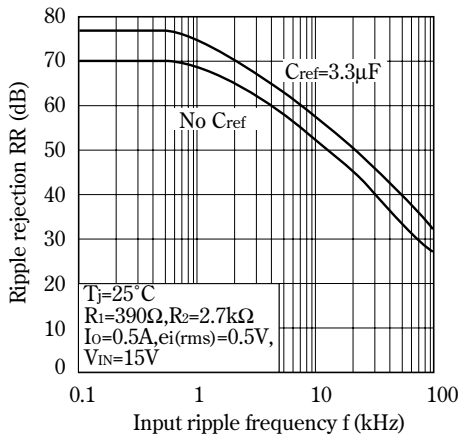

**Fig.16 Ripple Rejection vs. Output Current (PQ30RV1/PQ30RV11)**

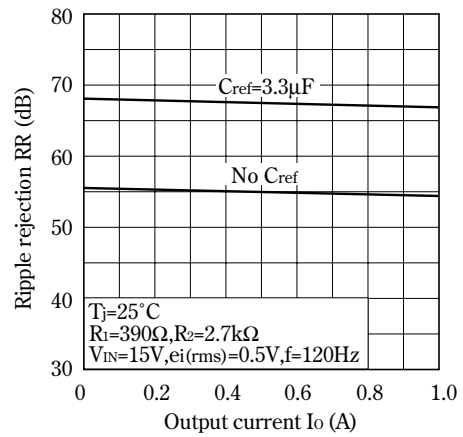

**Fig.17 Ripple Rejection vs. Output Current (PQ30RV2/PQ30RV21)**

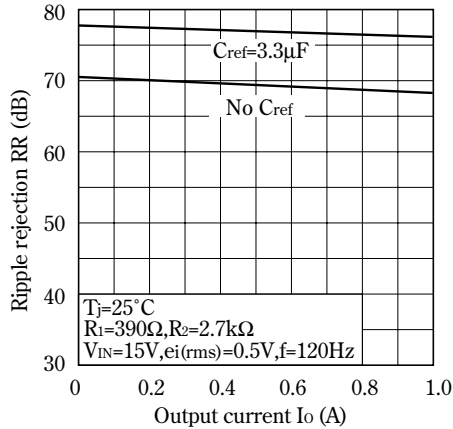

**Fig.18 Output Peak Current vs. Dropout Voltage (PQ30RV1/PQ30RV11)**

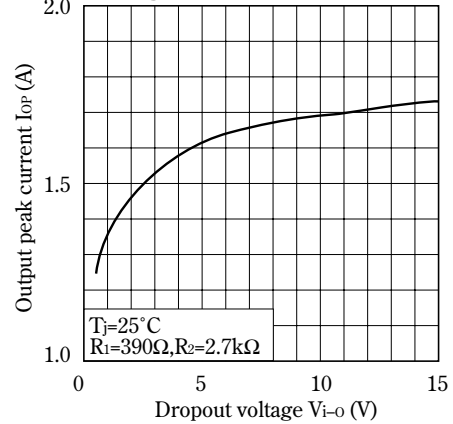

**Fig.19 Output Peak Current vs. Dropout Voltage (PQ30RV2/PQ30RV21)**

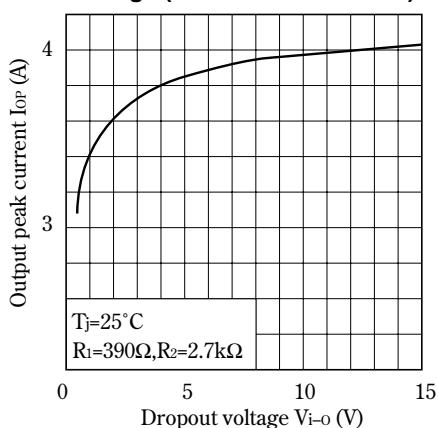

**Fig.20 Output Peak Current vs. Junction Temperature (PQ30RV1/PQ30RV11)**

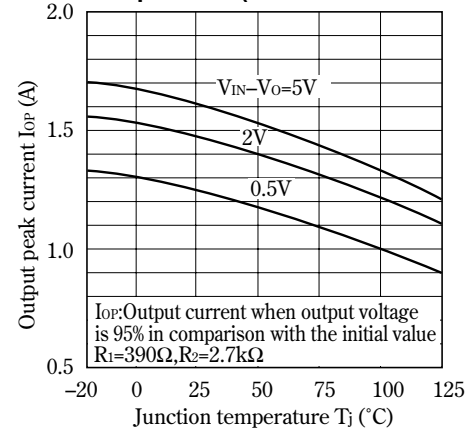
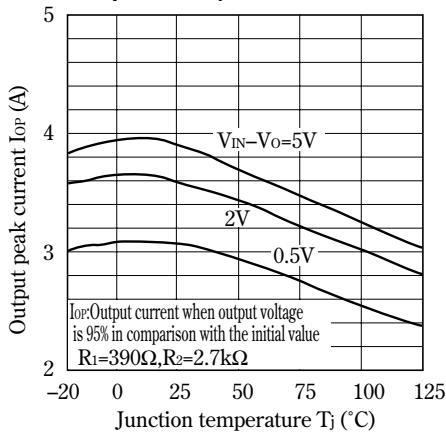
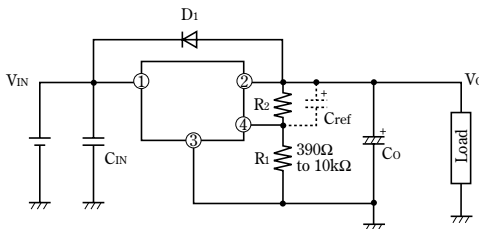

Fig.21 Output Peak Current vs. Junction Temperature (PQ30RV2/PQ30RV21)



■ Standard Connection



- D1 : This device is necessary to protect the element from damage when reverse voltage may be applied to the regulator in case of input short-circuiting.
- Cref : This device is necessary when it is required to enhance the ripple rejection or to delay the output start-up time(※1). (※1)Otherwise, it is not necessary. (Care must be taken since Cref may raise the gain, facilitating oscillation.) (※1)The output start-up time is proportional to CrefXR2.
- CIN, CO : Be sure to mount the devices CIN and CO as close to the device terminal as possible so as to prevent oscillation. The standard specification of CIN and CO is 0.33μF and 47μF, respectively. However, adjust them as necessary after checking.
- R1, R2 : These devices are necessary to set the output voltage. The output voltage Vo is given by the following formula:  

$$V_o = V_{ref} \times (1 + R_2/R_1)$$
 (Vref is 1.25V TYP)  
 The standard value of R1 is 390Ω. But value up to 10kΩ does not cause any trouble.

■ ON/OFF Operation

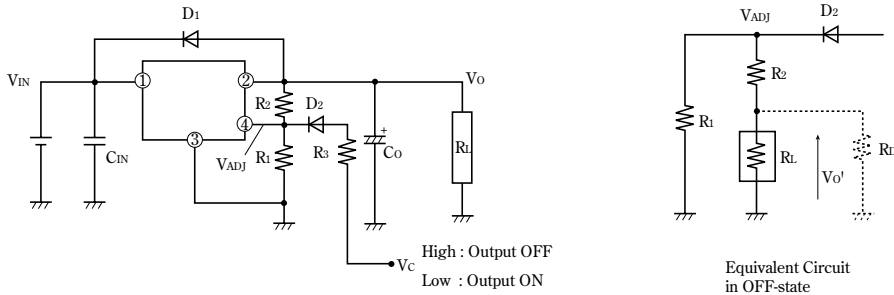

- ON/OFF operation is available by mounting externally D<sub>2</sub> and R<sub>3</sub>.
- When V<sub>ADJ</sub> is forcibly raised above V<sub>ref</sub>(1.25V TYP) by applying the external signal, the output is turned off (pass transistor of regulator is turned off). When the output is OFF, V<sub>ADJ</sub> must be higher than V<sub>ref</sub> MAX., and at the same time must be lower than maximum rating 7V.  
In OFF-state, the load current flows to R<sub>L</sub> from V<sub>ADJ</sub> through R<sub>2</sub>. Therefore the value of R<sub>2</sub> must be as high as possible.
- $V_o' = V_{ADJ} \times R_L / (R_L + R_2)$   
occurs at the load. OFF-state equivalent circuit R<sub>1</sub> up to 10kΩ is allowed. Select as high value of R<sub>1</sub> and R<sub>2</sub> as possible in this range. In some case, as output voltage is getting lower (V<sub>o</sub> < 1V), impedance of load resistance rises. In such condition, it is sometime impossible to obtain the minimum value of V<sub>o</sub>'. So add the dummy resistance indicated by R<sub>D</sub> in the figure to the circuit parallel to the load.

■ An Example of ON/OFF Circuit Using the 1-chip Microcomputer Output Port(PQ30RV1)

<Specification>  
 Output port of microcomputer  
 V<sub>OH</sub>(max)=0.5 V  
 V<sub>OH</sub>(min)=2.4 V (I<sub>OH</sub>=0.2mA)  
 MAX. rating of I<sub>OH</sub>=0.5mA  
 Output should be set as follows.  
 15.6V R<sub>L</sub>=52Ω(I<sub>O</sub>=0.3A)

From  $V_o = 1.25V(1 + R_2/R_1)$  we get  $V_o = 15.6V$ .  
 $R_2/R_1 = 11.48$   
 Assuming that V<sub>F</sub>(max)=0.8V for D<sub>2</sub> in case of V<sub>OH</sub>(min)=2.4V, we get  $V_{ADJ} = V_{OH}(min) - V_F(max) = 2.4V - 0.8V = 1.6V$ . From V<sub>ref</sub>(max)=1.3V we get R<sub>3</sub>=0Ω  
 If R<sub>1</sub>=10kΩ, we get  $R_2 = 11.48 \times R_1 = 114.8k\Omega$  and I<sub>OH</sub> as follows, ignoring R<sub>L</sub> (52Ω):  
 $I_{OH} = 1.6V \times (R_1 + R_2) / R_1 \times R_2$   
 $= 1.6V \times (10k\Omega + 114.8k\Omega) / 10k\Omega \times 114.8k\Omega = 0.17mA$   
 Hence, I<sub>OH</sub> < 0.2mA. Therefore V<sub>OH</sub>(min) is ensured.  
 Next, assuming that V<sub>F</sub>(min)=0.5V for D<sub>2</sub> in case of V<sub>OH</sub>(max), we get:  
 $I_{OH} = (5V - 0.5V) (R_1 + R_2) / R_1 \times R_2 = 0.49mA$  which is less than the rating.  
 Figure 1 shows the V<sub>o</sub>-V<sub>c</sub> characteristics when R<sub>1</sub>=10kΩ, R<sub>2</sub>=115kΩ, R<sub>3</sub>=0Ω, V<sub>IN</sub>=17V, R<sub>L</sub>=52Ω, and D<sub>1</sub>=1S2076A(Hitachi).

Output Voltage vs. Control Voltage(PQ30RV1)

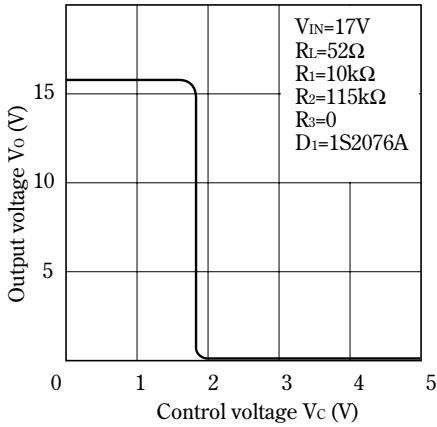

Model Line-ups for Lead Forming Type

Output current	1A output	2A output
Output voltage precision:±2.5%	PQ30RV1B	PQ30RV2B

Outline Dimensions(PQ30RV1B/PQ30RV2B)

(Unit : mm)

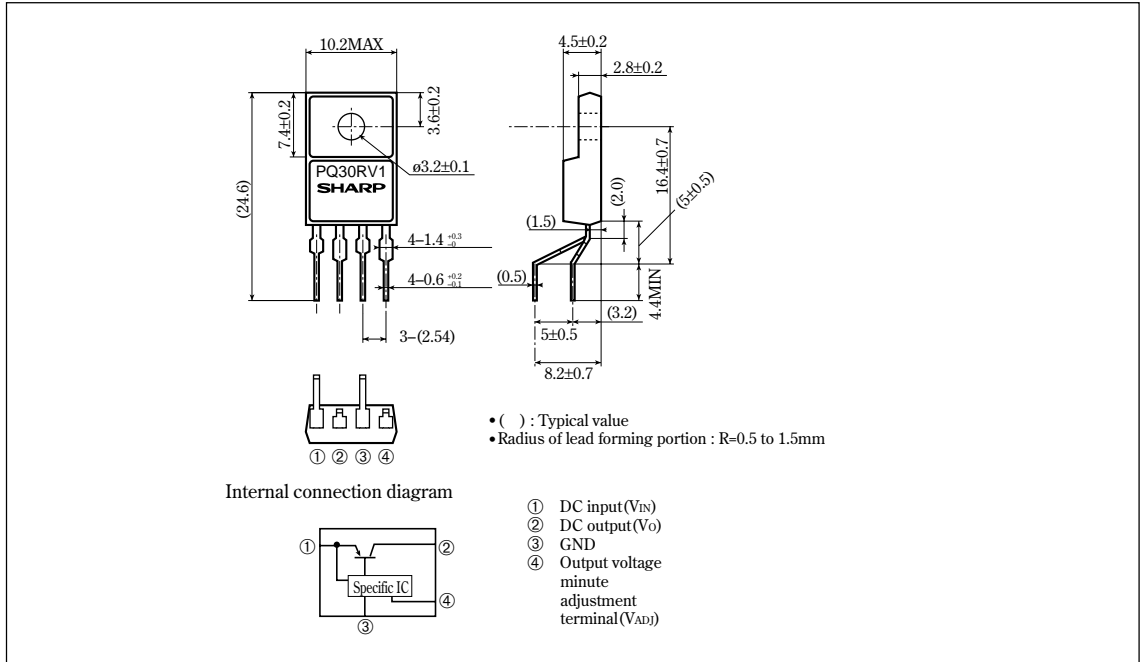

Note) The value of absolute maximum ratings and electrical characteristics is same as ones of PQ30RV1/2 series.



## NOTICE

- The circuit application examples in this publication are provided to explain representative applications of SHARP devices and are not intended to guarantee any circuit design or license any intellectual property rights. SHARP takes no responsibility for any problems related to any intellectual property right of a third party resulting from the use of SHARP's devices.
- Contact SHARP in order to obtain the latest device specification sheets before using any SHARP device. SHARP reserves the right to make changes in the specifications, characteristics, data, materials, structure, and other contents described herein at any time without notice in order to improve design or reliability. Manufacturing locations are also subject to change without notice.
- Observe the following points when using any devices in this publication. SHARP takes no responsibility for damage caused by improper use of the devices which does not meet the conditions and absolute maximum ratings to be used specified in the relevant specification sheet nor meet the following conditions:
  - (i) The devices in this publication are designed for use in general electronic equipment designs such as:
    - Personal computers
    - Office automation equipment
    - Telecommunication equipment [terminal]
    - Test and measurement equipment
    - Industrial control
    - Audio visual equipment
    - Consumer electronics
  - (ii) Measures such as fail-safe function and redundant design should be taken to ensure reliability and safety when SHARP devices are used for or in connection with equipment that requires higher reliability such as:
    - Transportation control and safety equipment (i.e., aircraft, trains, automobiles, etc.)
    - Traffic signals
    - Gas leakage sensor breakers
    - Alarm equipment
    - Various safety devices, etc.
  - (iii) SHARP devices shall not be used for or in connection with equipment that requires an extremely high level of reliability and safety such as:
    - Space applications
    - Telecommunication equipment [trunk lines]
    - Nuclear power control equipment
    - Medical and other life support equipment (e.g., scuba).
- Contact a SHARP representative in advance when intending to use SHARP devices for any "specific" applications other than those recommended by SHARP or when it is unclear which category mentioned above controls the intended use.
- If the SHARP devices listed in this publication fall within the scope of strategic products described in the Foreign Exchange and Foreign Trade Control Law of Japan, it is necessary to obtain approval to export such SHARP devices.
- This publication is the proprietary product of SHARP and is copyrighted, with all rights reserved. Under the copyright laws, no part of this publication may be reproduced or transmitted in any form or by any means, electronic or mechanical, for any purpose, in whole or in part, without the express written permission of SHARP. Express written permission is also required before any use of this publication may be made by a third party.
- Contact and consult with a SHARP representative if there are any questions about the contents of this publication.