

THRU-HOLE (THM) & SURFACE MOUNT (SMT) COIN CELL HOLDERS

23mm

AVAILABLE ON TAPE AND REEL

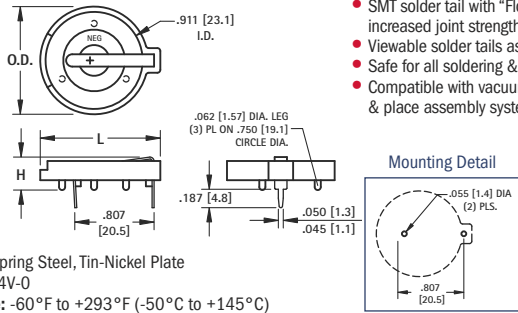

- Polarity clearly marked (+)
- Rugged construction, light weight
- SMT solder tail with "Flow-Hole" design for increased joint strength
- Viewable solder tails assures reliable joint inspection
- Safe for all soldering & reflow operations
- Compatible with vacuum and mechanical pick & place assembly systems



Surface Mount

Pad Layout

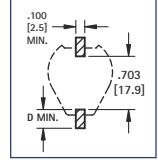

MATERIAL:

Contacts: .020 (.50) Spring Steel, Tin-Nickel Plate
Base: PBT, UL Rated 94V-0

Operating Temperature: -60°F to +293°F (-50°C to +145°C)

CAT. NO.	H	L	O.D.	NO. OF CELLS	BATTERY REFERENCE
104	.335 (8.5)	1.150 (29.2)	1.000 (25.4)	(1) Cell (Any 23mm)	BR2320, CR2320, CL2325, DL2330, CL2354, CR2335
107	.335 (8.5)	1.219 (31.0)	1.093 (27.8)	(1) Cell (Any 23mm)	
1027	.452 (11.5)	1.219 (31.0)	1.093 (27.8)	(2) 2320, (2) 2325, (2) 2330	

MATERIAL:

Contacts: .015 (.38) Steel

Base: High Temp Nylon 46, UL Rated 94V-0

Operating Temperature: -60°F to +293°F (-50°C to +145°C)

Tin-Nickel Plate		Gold Plate (Flash)		D PAD SIZE	BATTERY REFERENCE
CAT. NO.	ON TAPE BULK & REEL	CAT. NO.	ON TAPE BULK & REEL		
1071	1071TR	1091	1091TR	.156 (4.0)	CR2320, CL2325,
1073	1073TR	1083	1083TR	.278 (7.1)	DL2330, CR2335

Tape & Reel Spec's: 44mm wide; 32mm pitch; 13 inch reel, (200 pieces per reel)

Note: All conductive polystyrene carrier tape meets ANSI/EIA - 481 standard

24mm

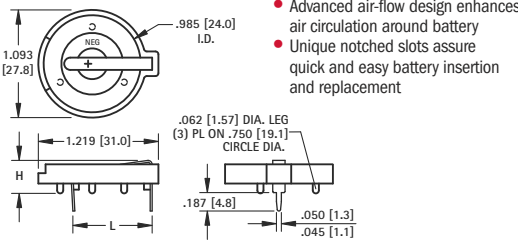

- Advanced air-flow design enhances air circulation around battery
- Unique notched slots assure quick and easy battery insertion and replacement

- Polarized holder
- Mounts securely for wave soldering
- Reliable spring tension assures low contact resistance



Thru Hole Mount

MATERIAL:

Base: PBT, UL Rated 94V-0

Contacts: .020 (.50) Spring Steel, Tin-Nickel Plate

Operating Temperature: -60°F to +293°F (-50°C to +145°C)

CAT. NO.	C	H	L	NO. OF CELLS	BATTERY REFERENCE
105	.064 (1.6)	.335 (8.5)	.805 (20.5)	(1) 2430	CR2430, CL2430, BR2450, CR2477
1025	.074 (1.9)	.452 (11.5)	.805 (20.5)	(1) 2450	
1025-7	.074 (1.9)	.503 (12.8)	.805 (20.5)	(1) 2477	
				(2) 2430	

Mounting Detail

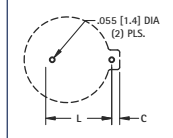

MATERIAL:

Base: PBT, UL Rated 94V-0

Contacts: .020 (.50) Spring Steel, Tin-Nickel Plate

Operating Temperature: -60°F to +293°F (-50°C to +145°C)

CAT. NO.	BATTERY REFERENCE
1068	(1) CR2450, (1) CL2450

Mounting Detail

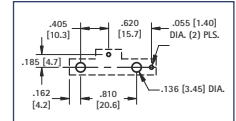

24mm TOP Loading

AVAILABLE ON TAPE AND REEL

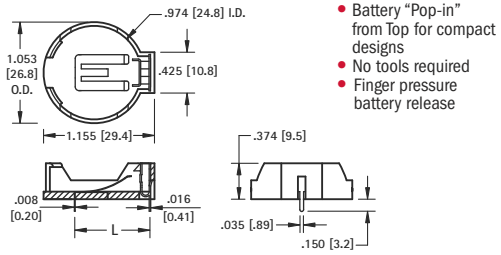

- Battery "Pop-in" from top for compact designs
- No tools required
- Finger pressure battery release

- Polarized holder
- Low profile for densely packed PCB's
- Compatible with vacuum and mechanical pick & place systems
- Conductive carrier tape meets ANSA/EIA- 481 standard



Surface Mount

MATERIAL:

Contacts: Phosphor Bronze, Nickel Plate

Base: High Temp Nylon 46, UL Rated 94V-0

Operating Temperature: -60°F to +293°F (-50°C to +145°C)

CAT. NO.	L	C	BATTERY REFERENCE
1053	.788 (20.0)	.048 (1.2)	(1) CR2450

Mounting Detail

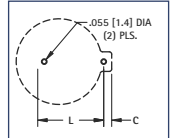

MATERIAL:

Base: LCP, UL Rated 94V-0

Contacts: .020 (.50) Spring Steel, Tin-Nickel Plate

Operating Temperature: -60°F to +293°F (-50°C to +145°C)

CAT. NO.	ON TAPE BULK & REEL	BATTERY REFERENCE
1052	1052TR	(1) CR2450

Tape & Reel Spec's: 56mm wide; 24mm pitch; 13 inch reel, (250 pieces per reel)

Mounting Detail

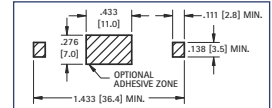

30mm

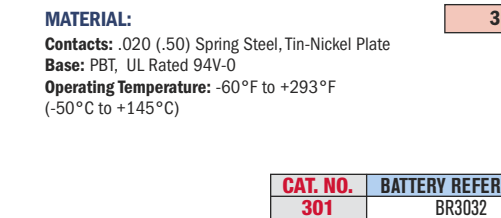

CAT. NO.	BATTERY REFERENCE
301	BR3032

MATERIAL:

Contacts: .020 (.50) Spring Steel, Tin-Nickel Plate

Base: PBT, UL Rated 94V-0

Operating Temperature: -60°F to +293°F (-50°C to +145°C)

Mounting Detail

